

SURGICAL INSTRUMENTS CATALOGUE

▪ ABOUT US

We are the original equipment manufacturers (OEM) for surgical instruments. Our product depth covers thousands of instruments ranging from the typical instruments used in the clinic to sophisticated instruments required during surgeries. We deem, however, pertinent to submit further that the range and scope of our production activities is not limited only to our product literature. We can produce instruments even if not depicted in our catalogue. We receive samples or photos or references from the world-renowned company's catalogue.

QUALITY CERTIFICATIONS

We have all the required Certifications like ISO 9001:2008, ISO 13485:2003 + AC 2009, cGMP (FDA) and CE.



COMMITMENT

Our commitment is to meet the changing needs of healthcare systems and to lead the industry by providing quality surgical instruments at competitive cost.

We understand the diverse needs of our customers and know that quality along with delivery times are the most important and common requirements of our customers from both the segments. This realization allows us to serve our customers in the most efficient and cost effective manner.

■ CONTENTS

01		Scalpels Skalpelle Bisturías	Page 01 to 05
02		Diagnostics Diagnostik Diagnóstico	Page 16 to 21
03		Trocars, Vaccination Impfen, Punktion Vacunación, Punción	Page 22 to 29
04		Anaesthesia Narkose Anestesia	Page 30 to 38
05		Scissors Scheren Tijeras	Page 39 to 81
06		Forceps Pinzetten Pinzas	Page 82 to 98
07		Artery Forceps Arterienklemmen Pinzas hemostáticas	Page 99 to 127
08		Cotton Swab Forceps Tupfer-und Kornzangen Pinzas para tapones y curaciones	Page 128 to 131
09		Suture Naht Sutura	Page 132 to 162
10		Probes, Applicators, Spatulas Sonden, Watteträger, Spatel Sondas, Porta-algodones, Espátulas	Page 163 to 168
11		Retractors Wundhaken und -sperrer Separadores	Page 169 to 217
12		Bone Surgery Knochenchirurgie Cirugía ósea	Page 218 to 291
13		Plaster Instruments Plaster Instrumente Instrumentos de yeso	Page 292 to 294

Page 295 to 334	Cardiovascular Surgery Herz- und Gefäßchirurgie Cirugía cardiovascular		14
Page 335 to 365	Neurosurgery Neurochirurgie Neuro Cirugía		15
Page 366 to 396	Ophthalmology Ophthalmologie Oftalmología		16
Page 397 to 414	Otology Otologie Otología		17
Page 415 to 439	Rhinology Rhinologie Rinología		18
Page 440 to 444	Oral Instruments Mund instrumente Cirugía oral		19
Page 445 to 451	Tonsil Mandel Amígdala		20
Page 452 to 456	Tracheotomy Tracheotomie Traqueotomía		21
Page 457	Goitre Kropfchirurgie Bocio		22
Page 458 to 459	Dermatology Dermatologie Dermatología		23
Page 460 to 481	Stomach, Intestine, Rectum Magen, Darm, Mastdarm Estómago, Intestinos, Recto		24
Page 482 to 495	Kidney, Liver, Gall Stone, Urology Niere, Leber, Galle, Urologie Riñón, Hígado, Bilis, Urología		25
Page 496 to 535	Gynecology Gynäkologie Ginecología		26

■ CONTENTS

27		Obstetrics Geburtshilfe Obstetricia	Page 536 to 542
28		Sterilization Sterilisation Esterilización	Page 543 to 544
29		Asepsis Asepsis Asepsia	Page 545 to 546
30		Hollowware Holloware Hollowware	Page 547 to 552

EN Scalpels

DE Skalpelle

ES Bisturías

Page 1 to 14



SCALPELS



Standard
01-1000-03 # 3

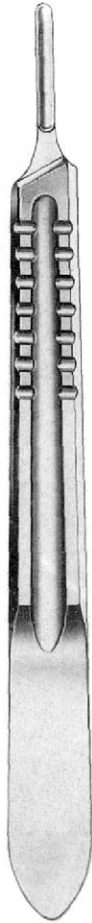

01-1001-03 # 3



01-1002-03 # 3



01-1003-3L # 3L
01-1003-3XL # 3XL

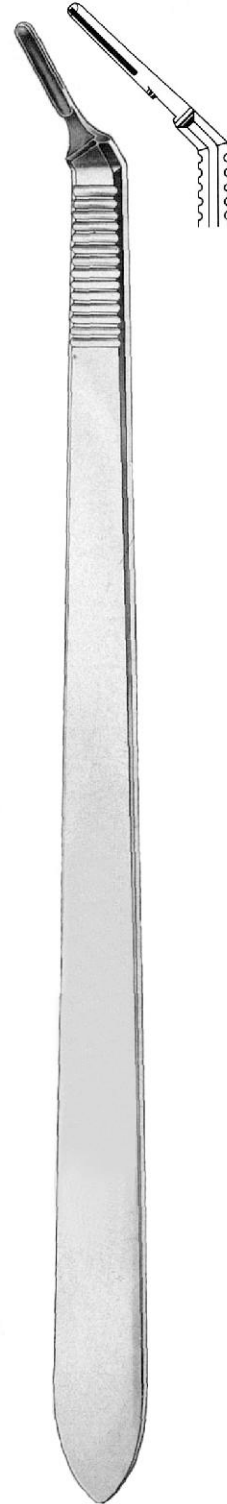

01-1004-3L # 3L
01-1004-3XL # 3XL
angled

SCALPELS

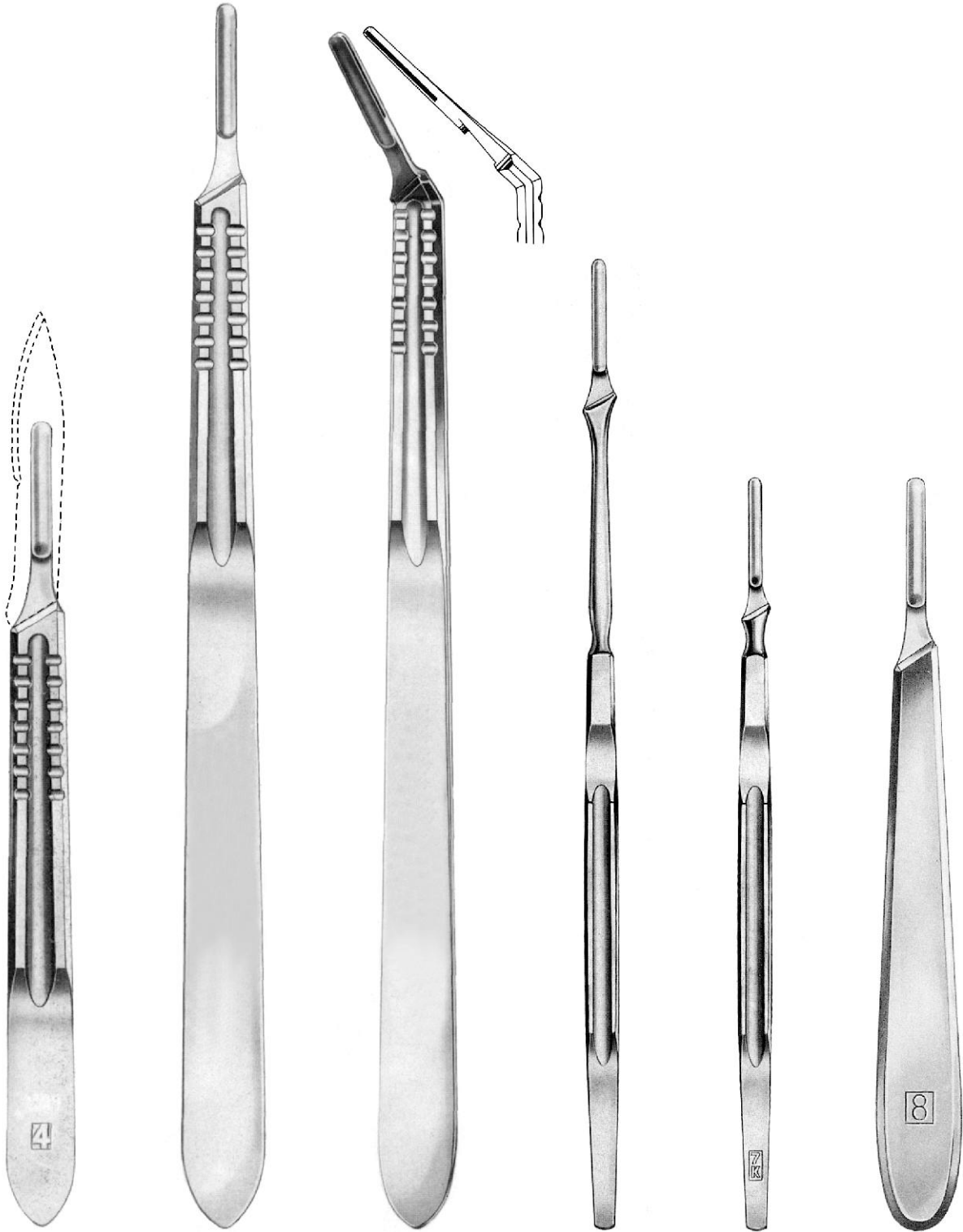

Standard
 01-1005-04 # 4

01-1006-4L # 4L
 01-1006-4XL # 4XL

01-1007-4L # 4L
 01-1007-4XL # 4XL
 angled

01-1008-07 # 7

01-1009-07 # 7K

Collin
 01-1010-08

SCALPELS

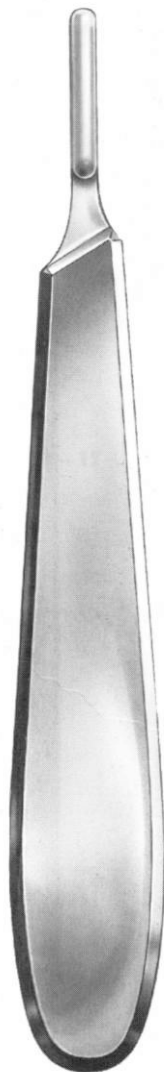

Collin
01-1011-09
Hollow, No. 9



Super
01-1012-10
Hollow, No. 10



01-1013-00
Hollow, round



01-1014-00
Plastics

SCALPELS



17cm/6¾"



Fig. 1

01-1015-01



Fig. 2

01-1015-02



Fig. 3

01-1015-03



Fig. 4

01-1015-04



Fig. 5

01-1015-05



Fig. 6

01-1015-06



Fig. 7

01-1015-07



Fig. 8

01-1015-08



Fig. 9

01-1015-09



Fig. 10

01-1015-10

SCALPELS



Fig. 1
01-1018-01



Fig. 2
01-1018-02



Fig. 3
01-1018-03



Fig. 4
01-1018-04



Fig. 5
01-1018-05



Fig. 6
01-1018-06



Fig. 7
01-1018-07



Fig. 8
01-1018-08



Fig. 9
01-1018-09



17cm/6¾"



Fig. 10
01-1018-10



Fig. 11
01-1018-11



Fig. 12
01-1018-12



Fig. 13
01-1018-13



Fig. 14
01-1018-14



Fig. 15
01-1018-15



Fig. 16
01-1018-16



Fig. 18
01-1018-18



Fig. 27
01-1018-27



Fig. 38
01-1018-38



Fig. 40
01-1018-40



Fig. 46
01-1018-46



Fig. 61
01-1018-61



Fig. 63
01-1018-63

SCALPELS



Dieffenbach
 17cm/6¾"



Fig. 1
 01-1019-01



Fig. 2
 01-1019-02



Fig. 3
 01-1019-03



Fig. 4
 01-1019-04



Fig. 5
 01-1019-05



Fig. 6
 01-1019-06



Fig. 7
 01-1019-07



Fig. 8
 01-1019-08



Fig. 9
 01-1019-09



Fig. 15
 01-1019-15



Fig. 16
 01-1019-16

SCALPELS



Bergmann
01-1020-01
14.5cm/5¾"



Fig. 2 01-1020-02
Fig. 3 01-1020-03
Fig. 4 01-1020-04



Dieffenbach
13cm/5¼"

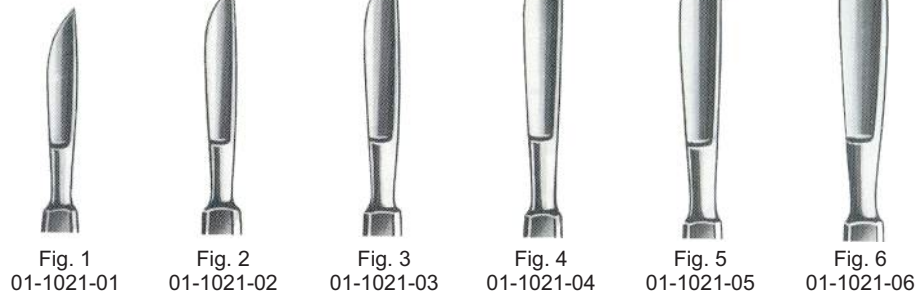

Fig. 1 01-1021-01
Fig. 2 01-1021-02
Fig. 3 01-1021-03
Fig. 4 01-1021-04
Fig. 5 01-1021-05
Fig. 6 01-1021-06



Fig. 7 01-1021-07
Fig. 8 01-1021-08
Fig. 9 01-1021-09
Fig. 10 01-1021-10
Fig. 11 01-1021-11
Fig. 12 01-1021-12

SCALPELS



Simon
20cm/8"



Fig. 1
01-1022-01



Fig. 2
01-1022-02



Fig. 3
01-1022-03



Fig. 4
01-1022-04



Ulrich
22.5 cm/9"



Fig. 1
01-1023-01



Fig. 2
01-1023-02



Fig. 3
01-1023-03



Simon
23.5 cm/9¼"



Fig. 1
01-1024-01



Fig. 2
01-1024-02



Fig. 3
01-1024-03



Fig. 4
01-1024-04



01-1025-01
7.5 cm/3"



01-1026-02
8 cm/3¼"

SCALPELS



Length of blades		Liston	Catlin	Langenbeck	Phalangeal knife	Interosseous knife
cm	in					
9.5	3 3/4					01-1031-09
11.0	4 1/2					01-1032-11
12.0	4 3/4					01-1030-12
13.0	5	01-1027-13				
15.0	6					
16.0	6 1/4	01-1027-16		01-1029-16		
17.0	6 3/4			01-1028-17		
19.0	7 1/2	01-1027-19		01-1029-19		
20.0	8			01-1028-20		
22.0	8 3/4	01-1027-22		01-1029-22		

SCALPELS



Langenbeck
 01-1033-01
 18 cm/7"

01-1033-02

Virchow

Length of blades

8.5 cm/3½"			01-1037-08
11.0 cm/4½"		01-1035-11	01-1036-11
14.0 cm/5½"		01-1035-14	
16.0 cm/6¼"	01-1034-16		
17.0 cm/6¾"		01-1035-17	
20.0 cm/8"	01-1034-20		
24.0 cm/9½"	01-1034-24		

SCALPELS

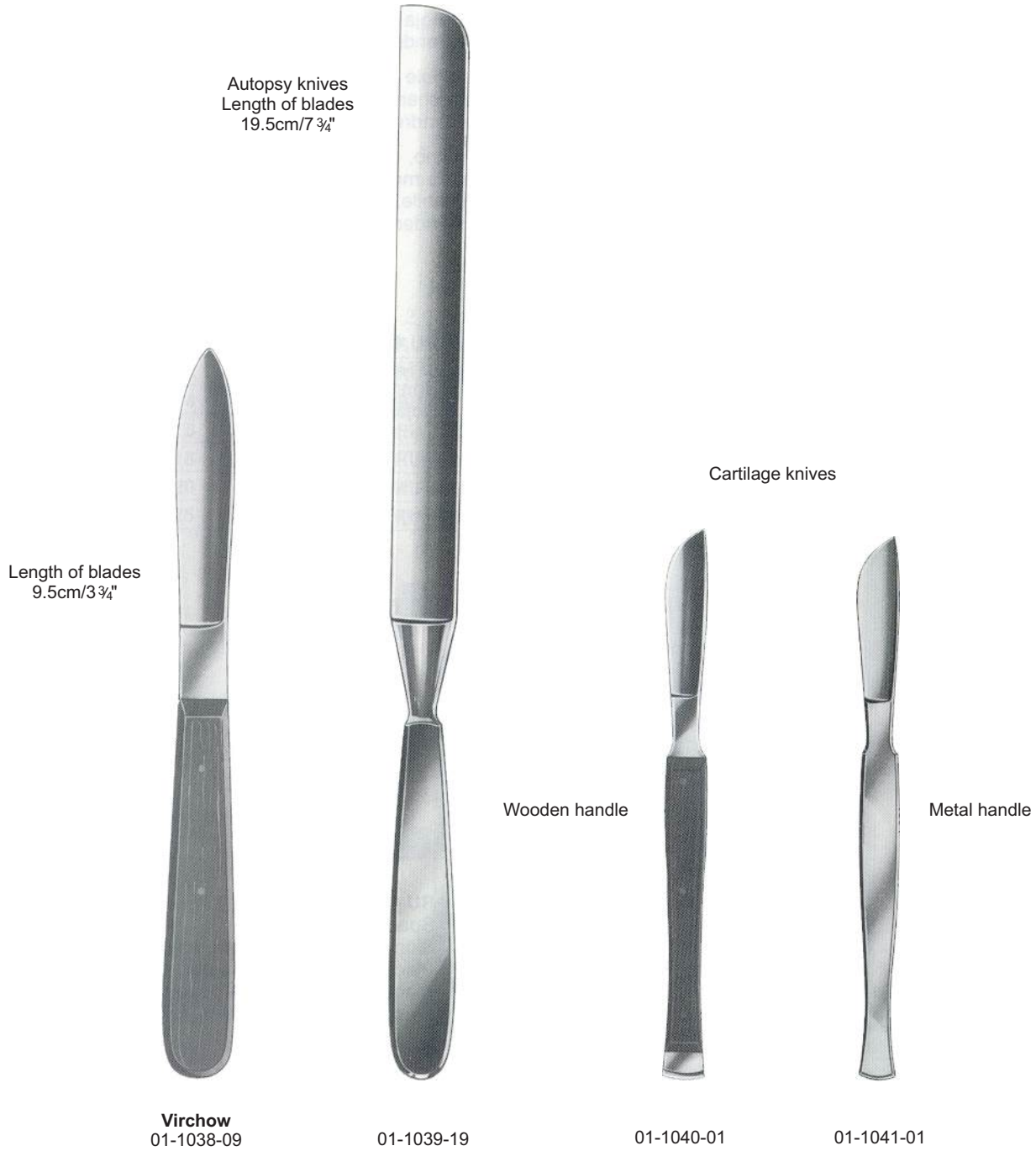

Autopsy knives
Length of blades
19.5cm/7 3/4"

Length of blades
9.5cm/3 3/4"

Cartilage knives

Wooden handle

Metal handle

Virchow
01-1038-09

01-1039-19

01-1040-01

01-1041-01

SCALPELS



Troutman-Chris
 01-1042-09
 9cm/3 1/2"



Troutman-Chris
 01-1043-09
 9cm/3 1/2"



01-1044-11
 11cm/4 1/2"



Castroviejo
 01-1045-13
 13cm/5 1/4"



01-1046-18
 18cm/7"

SCALPELS



Skull Breaker

01-1047-14
14 cm/5½"

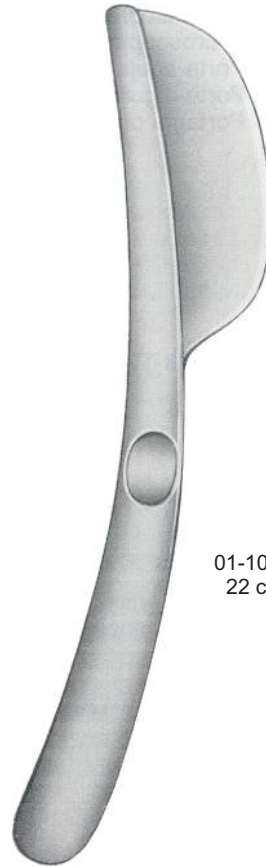

Rachiotome

01-1048-22
22 cm/8¾"



23 mm

Osteotome

01-1049-13
13 cm/5"



Brunetti
01-1050-28

Brunetti
01-1051-28

28.5 cm/11¼"

Muscle hooks



01-1052-06
6.5 cm/2½"



01-1053-07
7 cm/2¾"



01-1054-01

SCALPELS

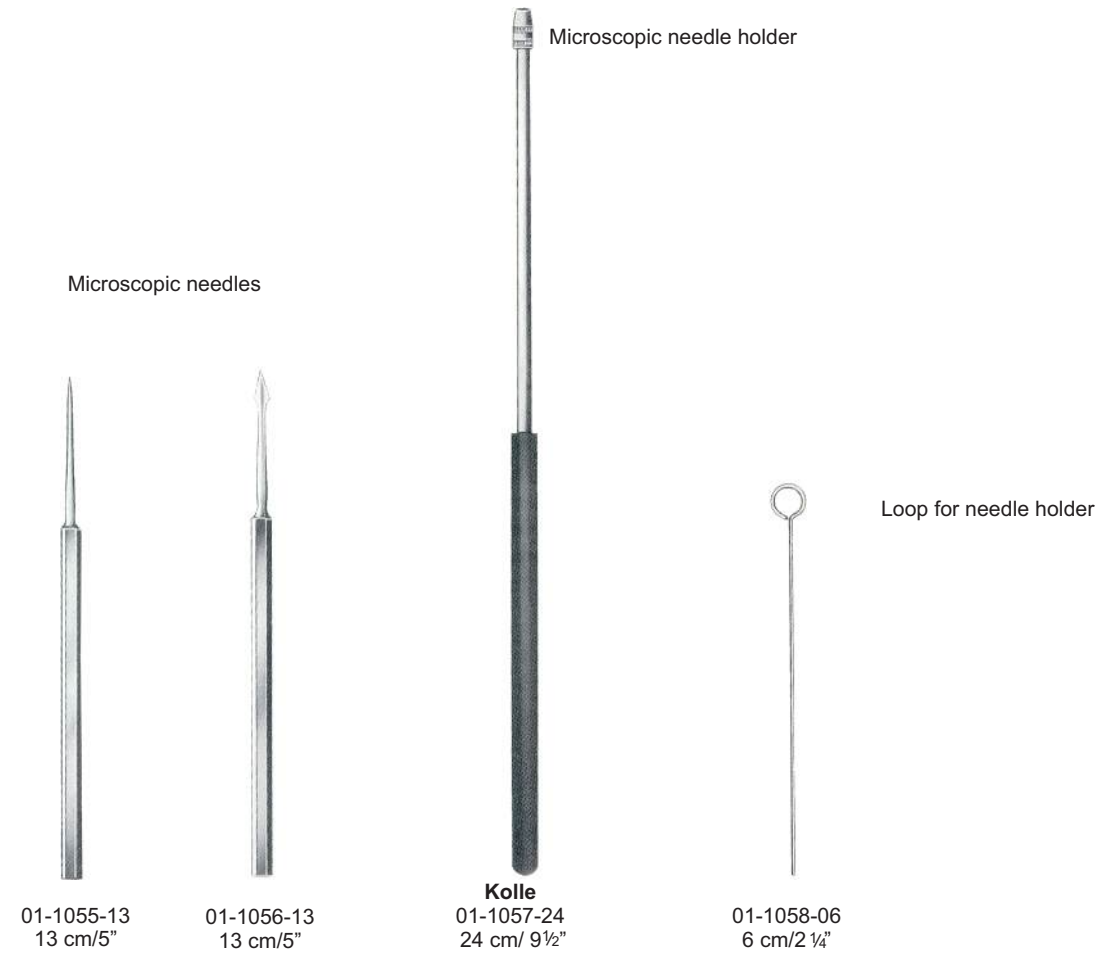

Post mortem needles

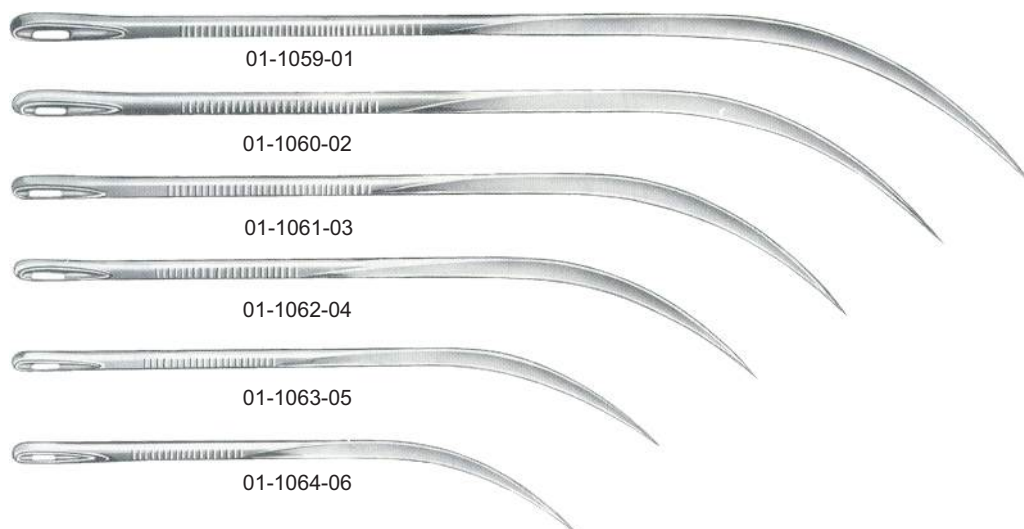

EN **Diagnostics**

DE **Diagnostik**

ES **Diagnóstico**

Page 15 to 20



DIAGNOSTICS

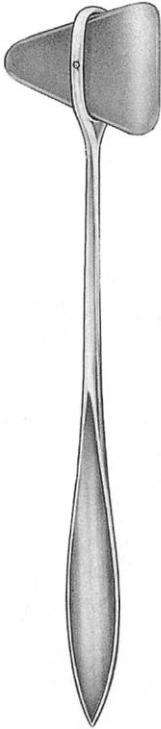

Taylor
02-1101-18 18.0cm
02-1101-20 20.0cm



Dejerine
02-1102-20 20.0cm



Dejerine
02-1103-21 21.0cm
02-1103-35 35.0cm



Neuro-Duoflex
02-1104-22 22.0cm

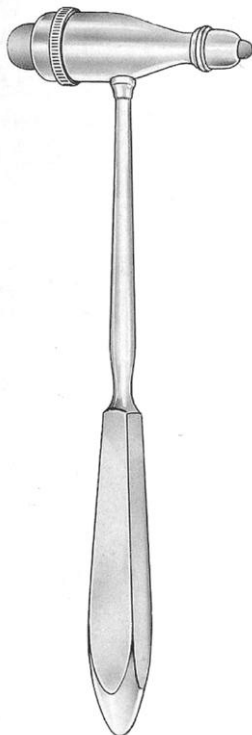

Troemner
02-1105-24 24.0cm

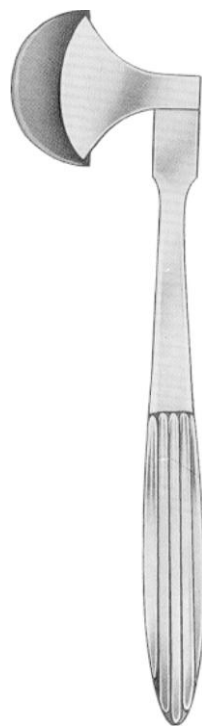

Berliner
02-1106-20
20cm/8"



Buck
02-1107-18 18.0cm



Buck (Telescopic)
02-1108-18 18.0cm

DIAGNOSTICS

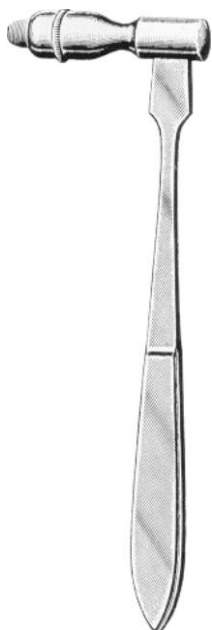

Traube
 02-1109-16
 16 cm/6 1/4"

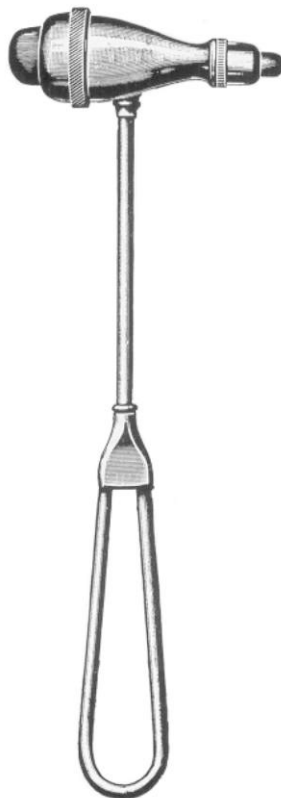

Troemner
 02-1110-21
 21cm/8 1/4"

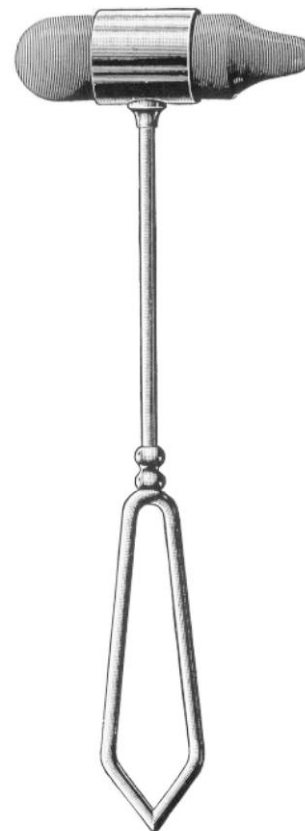

Divers-Duoflex
 02-1111-22
 22 cm/8 3/4"

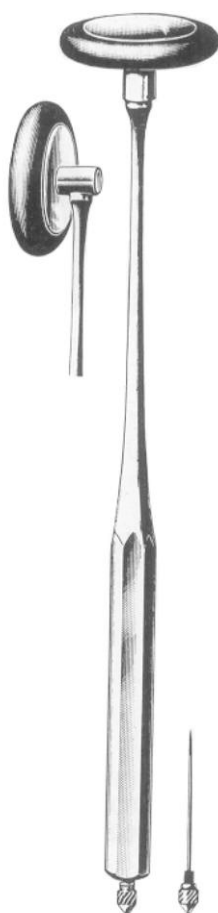

Babinsky
 02-1112-22 22 cm/8 3/4"
 02-1112-25 25 cm/10"

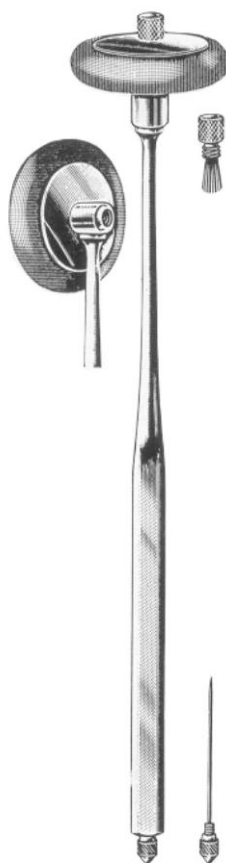

Rabiner
 02-1113-23
 23 cm/9 1/4"



National Hospital
 02-1114-33
 33 cm/13"



Queen Sqaure
 02-1115-26
 26 cm/10 1/4"

DIAGNOSTICS



Pinard
02-1116-18 18.0cm
(wooden)



Pinard
02-1117-15 15.0cm
(plastic)



Pinard
02-1118-15 15.0cm
(aluminum)

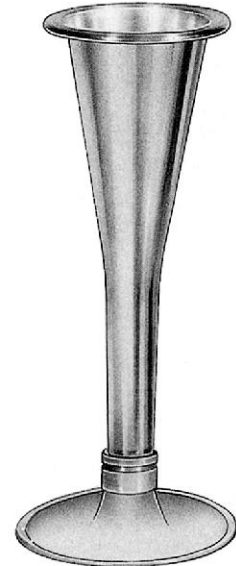

Pinard
02-1119-15 15.0cm
(aluminum)

Aly
02-1120-17
17cm/6¾"

Wartenberg
02-1121-19
19cm/7½"

Weber
02-1122-09
9cm/3½"



02-1123-15 15.0cm
02-1123-30 30.0cm
02-1123-60 60.0cm

DIAGNOSTICS

Goniometer

Moltgen
02-1124-00

Collin
for children 02-1125-01
for adults 02-1125-02

Townley
02-1126-10
10cm/4"

Caroll
02-1127-14
14cm/5½"

Chest piece only
02-1128-01

Chest piece only
02-1129-01

Ford
02-1128-00

Dual
02-1129-00

DIAGNOSTICS



02-1130-00



02-1131-00

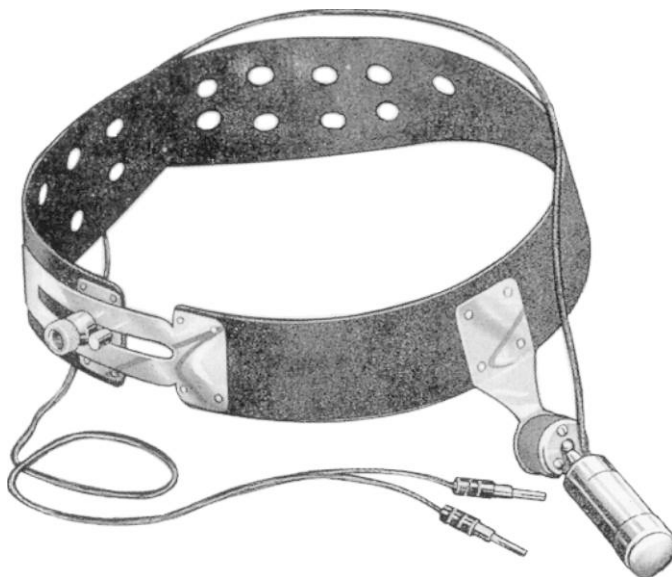

02-1132-00

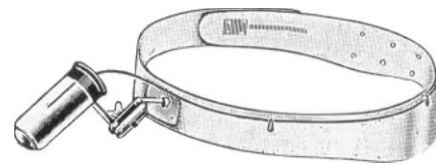

Jansen
02-1133-00

DIAGNOSTICS



02-1134-00
Otoscope set in Case



02-1135-00
Otoscope set in Pouch



02-1136-00
Ophthalmoscope set



02-1137-00
Ophthalmoscope and Otoscope set



02-1138-00
Complete ENT set

EN Trocars, Vaccination

DE Impfen, Punktion

ES Vacunación, Punción

Page 21 to 27



TROCARS, VACCINATION



Nelson
 Ø mm 21cm/8¼"
 7.5 03-1201-07
 9.0 03-1201-09
 10.5 03-1201-10
 12.0 03-1201-12

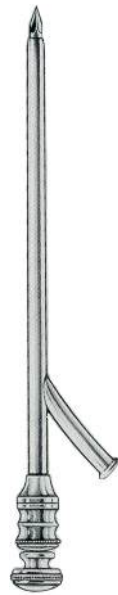

Ochsner
 Ø mm 14.5cm/5½"
 4.0 03-1202-40
 4.6 03-1202-46
 5.5 03-1202-55
 6.5 03-1202-65

Ø5.5 mm



Krause
 03-1203-15
 15cm/6"



Ø2.25 mm



Coakley
 03-1204-16
 16cm/6¼"

Ø1.8 mm



Lichtwitz
 03-1205-19
 19cm/7½"

Ø3 mm



Douglas
 03-1206-11
 11.5 cm/4 ½"



03-1207-11
 11.5 cm/4½"



Pierce
 Ø mm
 3.0 03-1208-03
 4.0 03-1208-04
 5.0 03-1208-05

TROCARS, VACCINATION

Ø 2 mm



Landau
 03-1209-16
 16cm/6¼"

Ø 2 mm



Landau
 03-1210-19
 19cm/7½"

Ø 13.5mm



Peau
 03-1211-16
 16cm/6¼"

Ø 8 mm

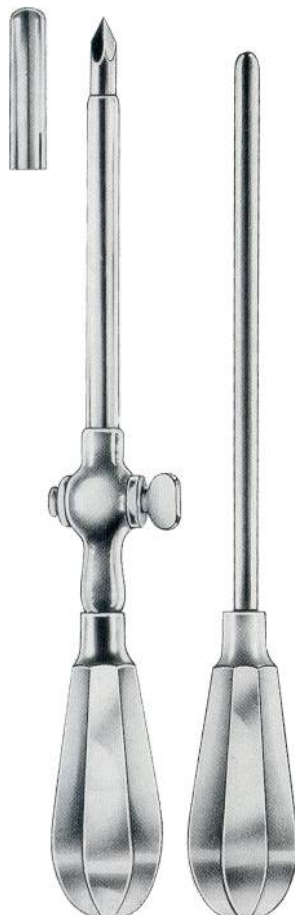

Buelau
 03-1212-24
 24cm/9½"

TROCARS, VACCINATION

Brain Suction Tubes



- ∅
- | | |
|--------|------------|
| 2.0 mm | 03-1213-20 |
| 2.5 mm | 03-1213-25 |
| 3.0 mm | 03-1213-30 |
| | 13cm/5" |



- ∅
- | | |
|--------|------------|
| 1.5 mm | 03-1214-15 |
| 2.0 mm | 03-1214-20 |
| 2.5 mm | 03-1214-25 |
| 3.0 mm | 03-1214-30 |
| | 19.5cm/7¾" |



- Adson**
03-1215-02
21cm/8¼"
∅4 mm

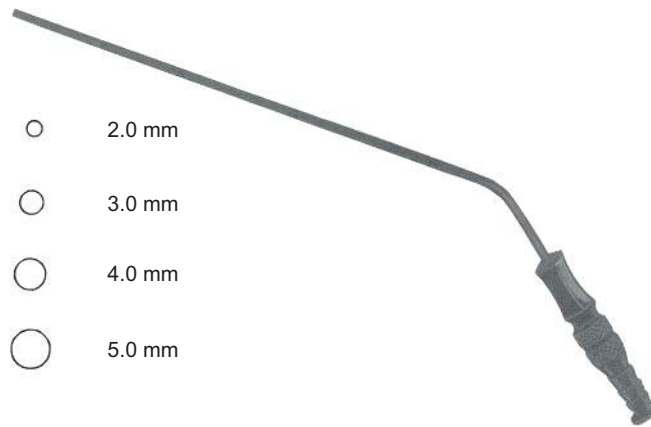

- 2.0 mm
- 3.0 mm
- 4.0 mm
- 5.0 mm

- ∅ malleable, black
- | | |
|------|------------|
| 2 mm | 03-1216-02 |
| 3 mm | 03-1216-03 |
| 4 mm | 03-1216-04 |
| 5 mm | 03-1216-05 |
| | 19.5cm/7¾" |

TROCARS, VACCINATION

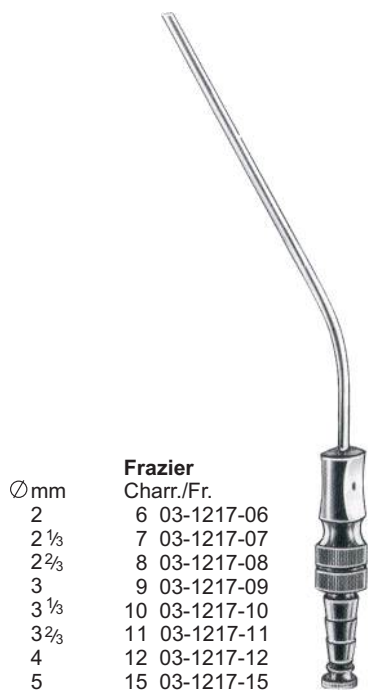

Ømm	Frazier Charr./Fr.
2	6 03-1217-06
2 1/3	7 03-1217-07
2 2/3	8 03-1217-08
3	9 03-1217-09
3 1/3	10 03-1217-10
3 2/3	11 03-1217-11
4	12 03-1217-12
5	15 03-1217-15



Ømm	Ferguson Charr./Fr.
2	6 03-1218-06
2 1/3	7 03-1218-07
2 2/3	8 03-1218-08
3	9 03-1218-09
3 1/3	10 03-1218-10
3 2/3	11 03-1218-11
4	12 03-1218-12

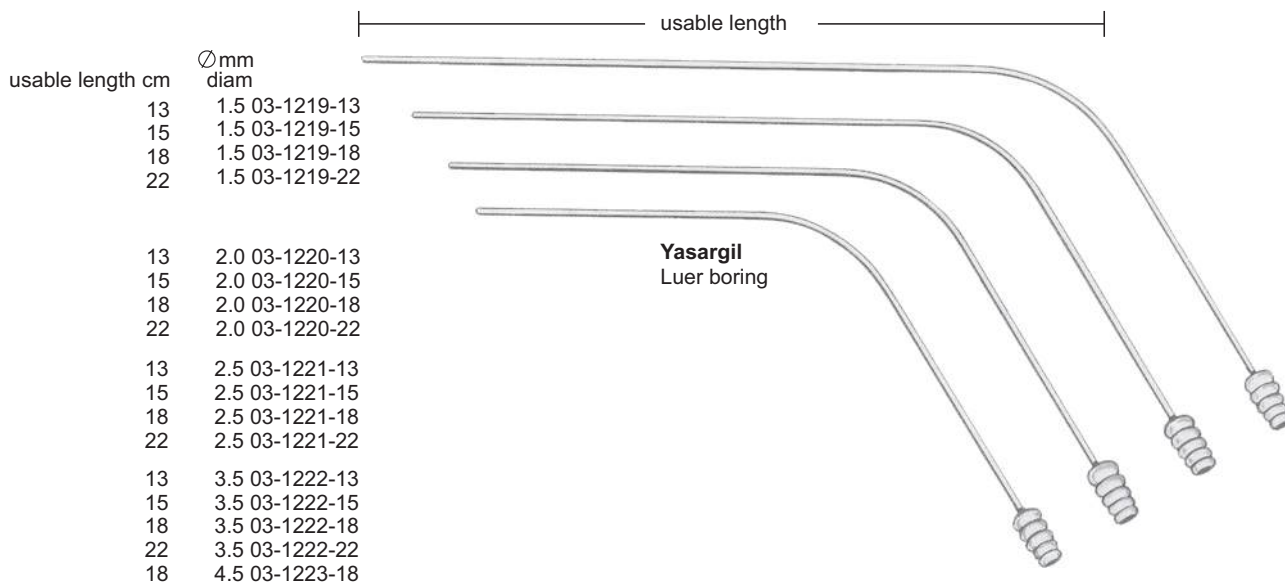

usable length cm	Ømm diam
13	1.5 03-1219-13
15	1.5 03-1219-15
18	1.5 03-1219-18
22	1.5 03-1219-22
13	2.0 03-1220-13
15	2.0 03-1220-15
18	2.0 03-1220-18
22	2.0 03-1220-22
13	2.5 03-1221-13
15	2.5 03-1221-15
18	2.5 03-1221-18
22	2.5 03-1221-22
13	3.5 03-1222-13
15	3.5 03-1222-15
18	3.5 03-1222-18
22	3.5 03-1222-22
18	4.5 03-1223-18

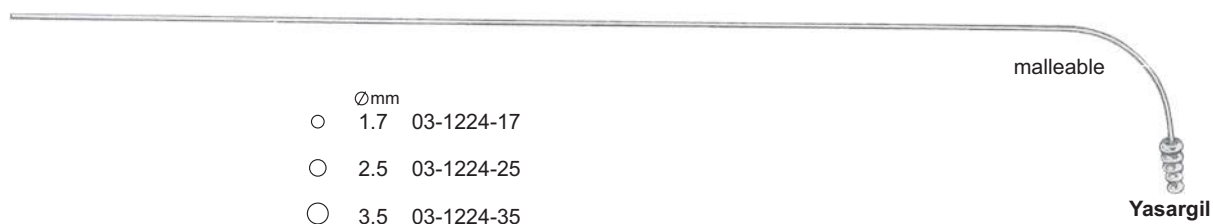

Ømm	
○ 1.7	03-1224-17
○ 2.5	03-1224-25
○ 3.5	03-1224-35

TROCARS, VACCINATION



Yankauer
03-1225-27
27cm/10½"



Yankauer
03-1226-27
27cm/10½"



Yankauer
03-1227-01



Fig. 0
03-1227-10



Fig. 1
03-1227-11

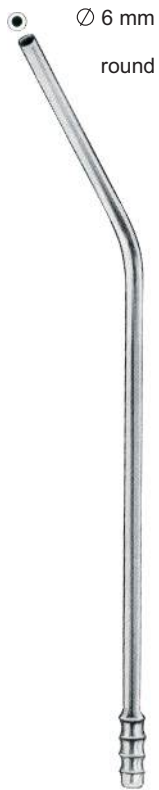

Fig. 2
03-1227-12



Fig. 3
03-1227-13

03-1227-50 SET



∅ 6 mm
round

Nuboer
03-1228-01
21cm/8¼"



6 mm
ovale

Nuboer
03-1229-02
21cm/8¼"



∅ 6 mm

Andrew-Pynchon
03-1230-23
23 cm/9"

TROCARS, VACCINATION

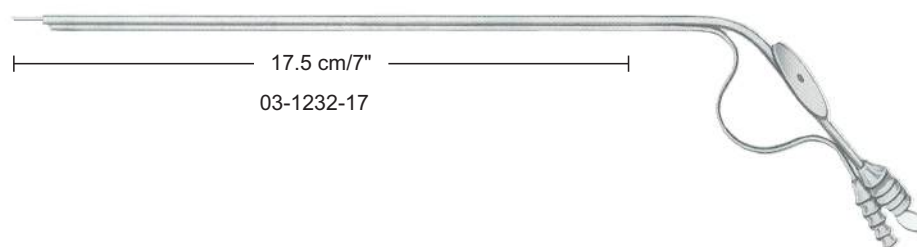
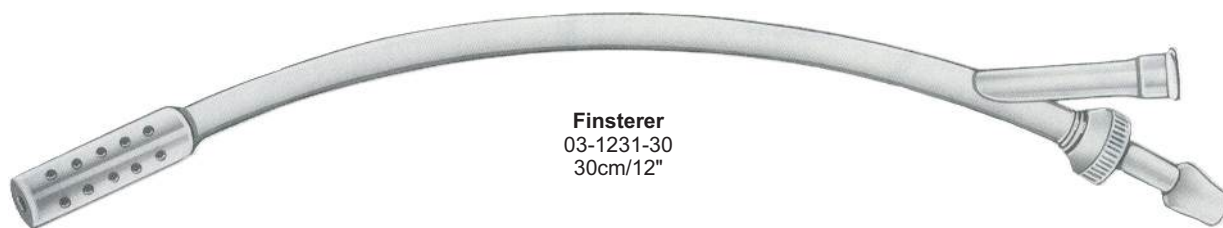

Ø 6 mm



Baby-Poole
 03-1233-20
 20cm/8"

Ø10 mm



Poole
 03-1234-22
 22cm/8¾"

Ø 8 mm



Poole
 03-1235-22
 22cm/8¾"

TROCARS, VACCINATION



Yankauer
03-1236-34
34.5cm/13¼"

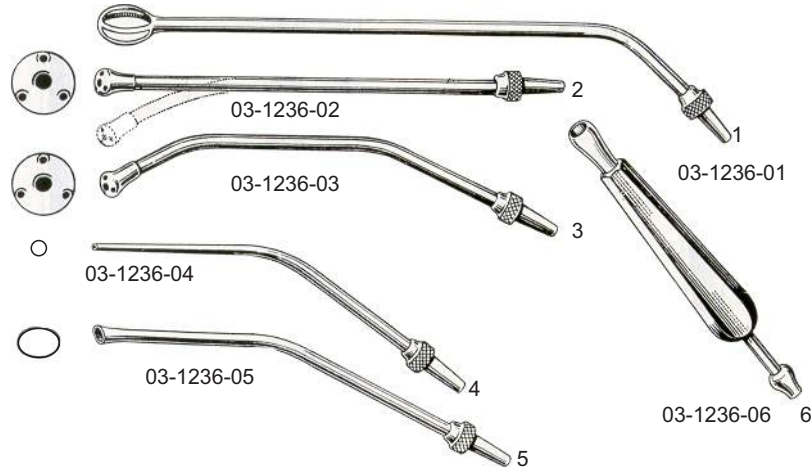

Yankauer universal
Complete Set
03-1236-60



Magill
03-1237-01=20cm/8"
03-1237-02=20cm/8"
03-1237-03=20cm/8"



Millin
03-1238-30
30cm/12"



Simpson-Smith
03-1239-00

EN Anaesthesia

DE Narkose

ES Anestesia

Page 28 to 36



ANAESTHESIA



Miller
04-1301-30
04-1301-40

04-1301-30
Laryngoscope Set
Consisting of:
04-1301-00 Battery Handle (without batteries)
04-1301-11 McIntosh blade, Fig 1
04-1301-12 ditto, Fig 2
04-1301-13 ditto, Fig 3

04-1301-40
Laryngoscope Set
Consisting of:
04-1301-00 Battery Handle (without batteries)
04-1301-11 McIntosh blade, Fig 1
04-1301-12 McIntosh blade, Fig 2
04-1301-13 McIntosh blade, Fig 3
04-1301-14 McIntosh blade, Fig 4

McIntosh Laryngoscope Blades
04-1301-10 Fig 0, Working length 55mm, baby's
04-1301-11 Fig 1, Working length 75mm, children's
04-1301-12 Fig 2, Working length 90mm, adolescent's
04-1301-13 Fig 3, Working length 110mm, women's
04-1301-14 Fig 4, Working length 135mm, men's

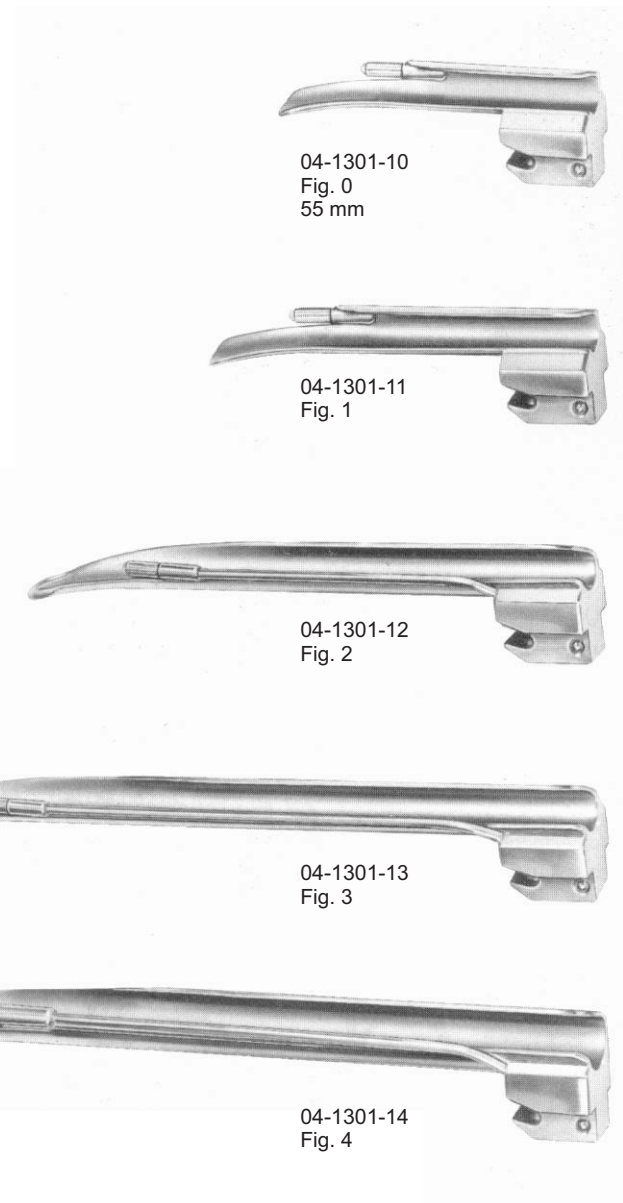

04-1301-10
Fig. 0
55 mm

04-1301-11
Fig. 1

04-1301-12
Fig. 2

04-1301-13
Fig. 3

04-1301-14
Fig. 4

ANAESTHESIA

04-1302-30
 Laryngoscope Set
 Consisting of:
 04-1302-00 Battery Handle (without batteries)
 04-1302-11 McIntosh blade, Fig 1
 04-1302-12 ditto, Fig 2
 04-1302-13 ditto, Fig 3

McIntosh
 04-1302-30
 04-1302-40

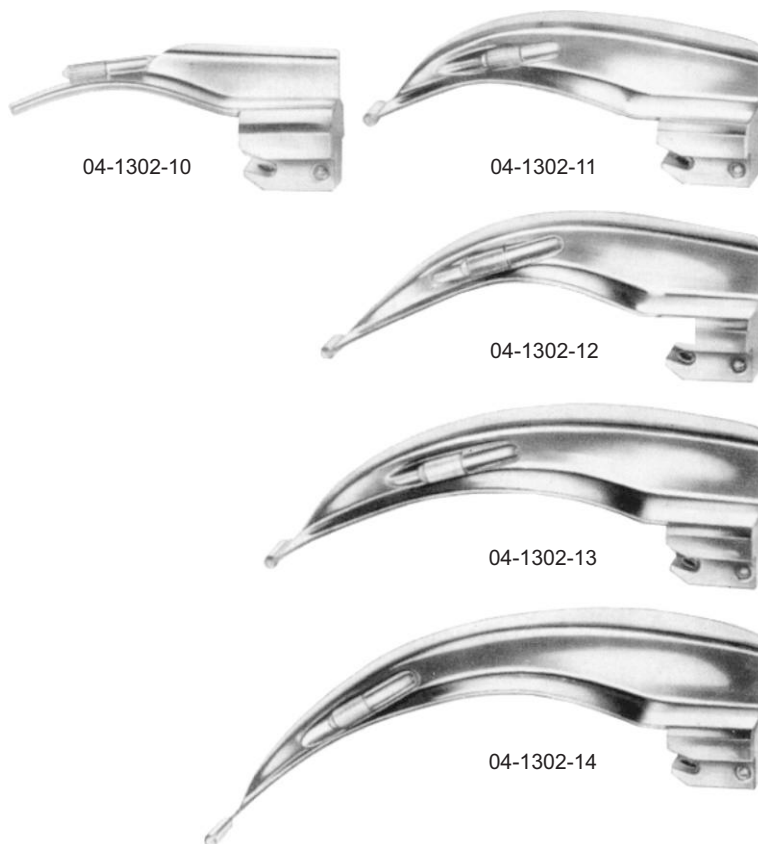

04-1302-40
 Laryngoscope Set
 Consisting of:
 04-1302-00 Battery Handle (without batteries)
 04-1302-11 McIntosh blade, Fig 1
 04-1302-12 McIntosh blade, Fig 2
 04-1302-13 McIntosh blade, Fig 3
 04-1302-14 McIntosh blade, Fig 4

McIntosh Laryngoscope Blades
 04-1302-10 Fig 0, Working length 55mm, baby's
 04-1302-11 Fig 1, Working length 75mm, children's
 04-1302-12 Fig 2, Working length 90mm, adolescent's
 04-1302-13 Fig 3, Working length 110mm, women's
 04-1302-14 Fig 4, Working length 135mm, men's

ANAESTHESIA

04-1303-30
Laryngoscope Set
Consisting of:
04-1303-00 Battery Handle (without batteries)
04-1303-12 Foregger Blade, Fig 2
04-1303-13 ditto, Fig 3
04-1303-14 ditto, Fig 4

Foregger
04-1303-30
04-1303-40

04-1303-40
Laryngoscope Set
Consisting of:
04-1303-00 Battery Handle (Without batteries)
04-1303-11 Foregger Blade, Fig 1
04-1303-12 Foregger Blade, Fig 2
04-1303-13 Foregger Blade, Fig 3
04-1303-14 Foregger Blade, Fig 4

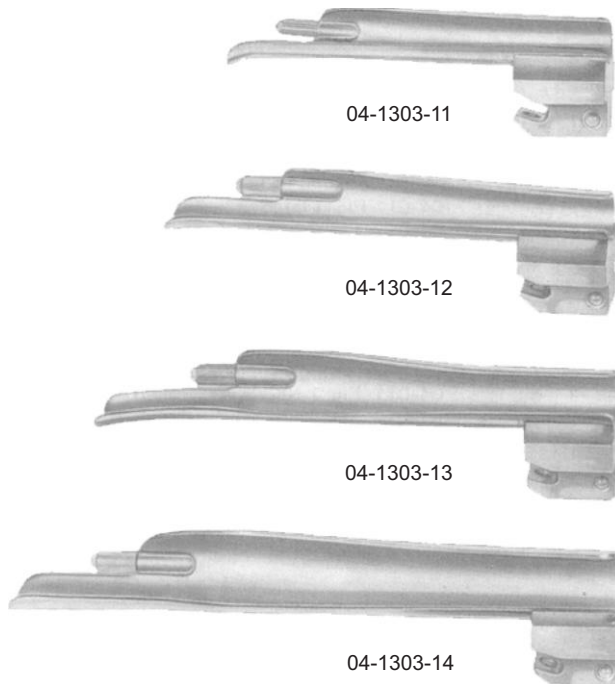

Foregger Laryngoscope Blade,
04-1303-11 Fig 1, working length 70mm, children's
04-1303-12 Fig 2, working length 90mm, adolescent's
04-1303-13 Fig 3, working length 110mm, women's
04-1303-14 Fig 4, working length 135mm, men's

ANAESTHESIA

04-1304-30
 Laryngoscope Set
 Consisting of:
 04-1304-00 Battery Handle (without batteries)
 04-1304-12 Guedel-Negus Blade, Fig 2
 04-1304-13 ditto, Fig 3
 04-1304-14 ditto, Fig 4

Guedel-Negus
 04-1304-30
 04-1304-40



04-1304-11



04-1304-12



04-1304-13



04-1304-14

04-1304-40
 Laryngoscope Set
 Consisting of:
 04-1304-00 Battery Handle (without batteries)
 04-1304-11 Guedel-Negus Blade, Fig 1
 04-1304-12 Guedel-Negus Blade, Fig 2
 04-1304-13 Guedel-Negus Blade, Fig 3
 04-1304-14 Guedel-Negus Blade, Fig 4

Guedel Laryngoscope Blades
 04-1304-11 Fig 1, working length 70mm, children's
 04-1304-12 Fig 2, working length 90mm, adolescent's
 04-1304-13 Fig 3, working length 110mm, women's
 04-1304-14 Fig 4, working length 135mm, men's

ANAESTHESIA

COLD LIGHT LARYNGOSCOPES



04-1305-00
handle with lamp

McINTOSH
with fiberoptic



04-1305-50
set with 5 blades

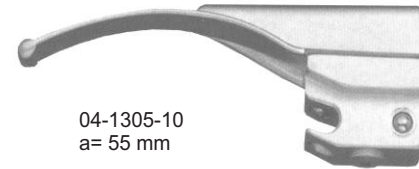
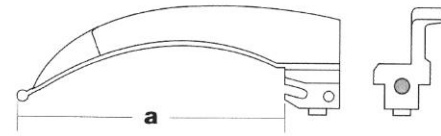

04-1305-10
a= 55 mm

Fig. 0

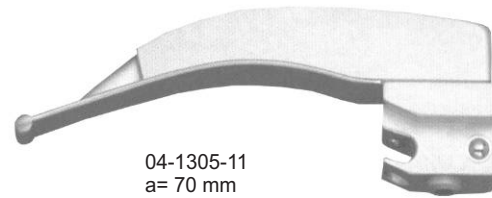

04-1305-11
a= 70 mm

Fig. 1

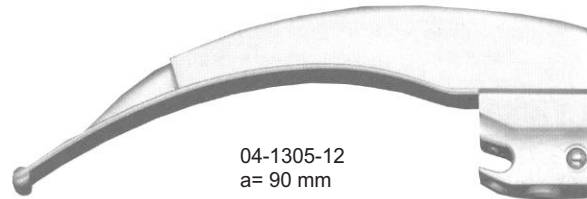

04-1305-12
a= 90 mm

Fig.2

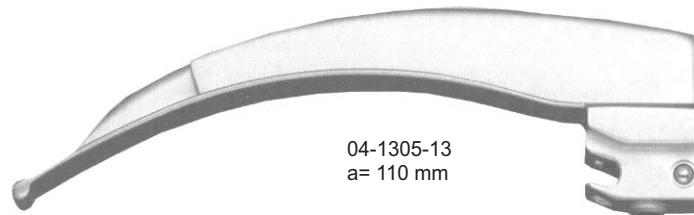

04-1305-13
a= 110 mm

Fig. 3

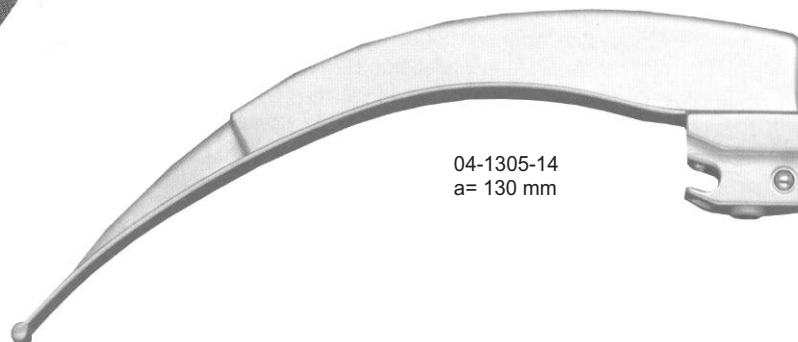

04-1305-14
a= 130 mm

Fig.4

ANAESTHESIA

COLD LIGHT LARYNGOSCOPES



04-1306-50
set with 5 blades

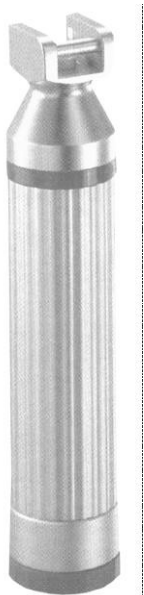

04-1306-00
handle with lamp

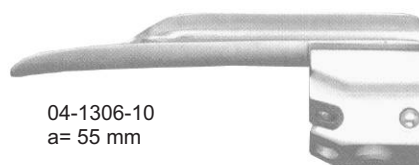
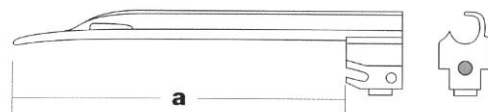

04-1306-10
a= 55 mm

Fig. 0

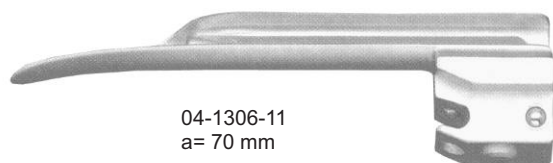

04-1306-11
a= 70 mm

Fig. 1

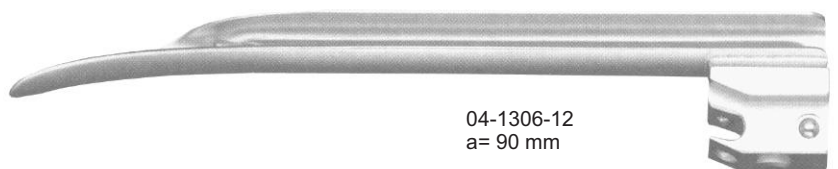

04-1306-12
a= 90 mm

Fig. 2



04-1306-13
a= 110 mm

Fig. 3



04-1306-14
a= 130 mm

Fig. 4

ANAESTHESIA

 Working length 55 mm
04-1307-10

 Working length 80 mm
04-1307-11

Miller-Baby
04-1307-20

04-1307-20
Laryngoscope Set, Baby and Infant,
consisting of :
04-1307-00 Battery Handle (without battery)
04-1307-10 Miller-baby blade, Fig 0
working length 55 mm
04-1307-11 ditto, Fig 1 working length 80 mm

Negus
18 mm dia
04-1308-00

Conventional Handles

	Size	Batteries
04-1309-01	Medium/Standard	2C
04-1309-02	Small/Penlight	2AA
04-1309-03	Stubby	2AA
04-1309-04	Large	2D

Fiber Optic Handles

	Size	Batteries
04-1310-01	Medium/Standard	2C
04-1310-02	Small/Penlight	2AA
04-1310-03	Stubby	2AA
04-1310-04	Large	2D

ANAESTHESIA



Schimmelbusch
 04-1311-01 Child
 04-1311-02 Adult



Magill
 04-1312-15 15 cm/6" Infant
 04-1312-20 20 cm/8" Child
 04-1312-25 25 cm/10" Adult

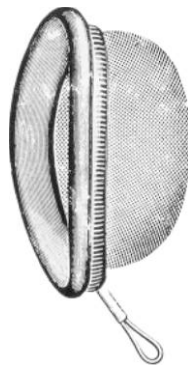

Yankauer
 04-1313-01 Child
 04-1313-02 Adult



Connel
 04-1314-01 Child
 04-1314-02 Adult

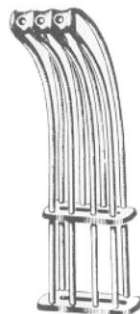

04-1315-01



Lumbard-Mayo
 04-1315-02



04-1315-03

ANAESTHESIA

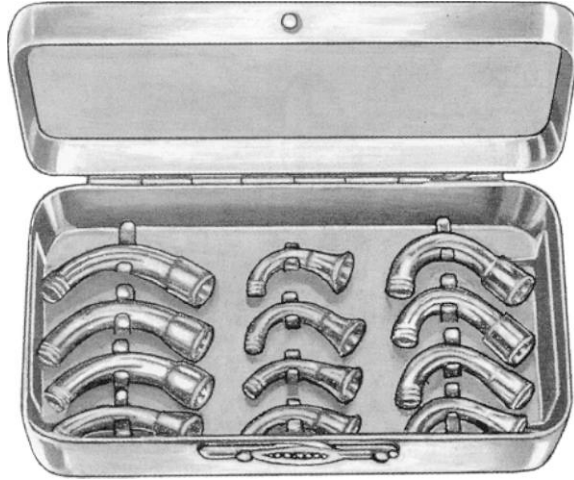

Magill
 Connection Set
 04-1316-00



Magill (Nasal)	
	mm dia
04-1316-01	5.5
04-1316-02	6.5
04-1316-03	7.5
04-1316-04	8.0
04-1316-05	8.5
04-1316-06	9.5
04-1316-07	10.0
04-1316-08	10.5



Magill (Aural)	
	mm dia
04-1317-01	5.5
04-1317-02	6.5
04-1317-03	7.5
04-1317-04	8.0
04-1317-05	8.5
04-1317-06	9.5
04-1317-07	10.0
04-1317-08	10.5

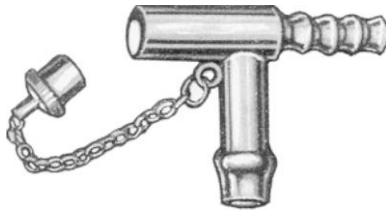

Cobb
 04-1318-01 Small
 04-1318-02 Medium
 04-1318-03 Large

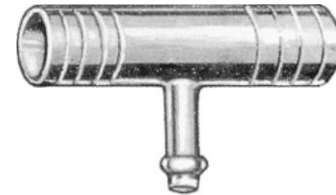

Ayre
 04-1319-01 Small
 04-1319-02 Medium
 04-1319-03 Large



Hamilton Bailey
 04-1320-01 Infant
 04-1320-02 Child
 04-1320-03 Adult

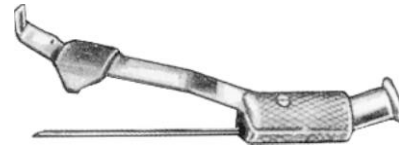

Mitchell
 04-1321-18
 04-1321-20
 38 mm

EN Scissors

DE Scheren

ES Tijeras

Page 37 to 94



SCISSORS



Straight

Standard
Fig. 1

10.0	cm/4"	05-1401-10
11.5	cm/4½"	05-1401-11
13.0	cm/5"	05-1401-13
14.5	cm/5¾"	05-1401-14
15.5	cm/6"	05-1401-15
16.0	cm/6¼"	05-1401-16
18.0	cm/7"	05-1401-18
20.0	cm/8"	05-1401-20



Straight

Standard
Fig. 2

05-1402-10
05-1402-11
05-1402-13
05-1402-14
05-1402-15
05-1402-16
05-1402-18
05-1402-20



Straight

Standard
Fig. 3

05-1403-10
05-1403-11
05-1403-13
05-1403-14
05-1403-15
05-1403-16
05-1403-18
05-1403-20



Curved

Standard
Fig. 1

10.0	cm/4"	05-1404-10
11.5	cm/4½"	05-1404-11
13.0	cm/5"	05-1404-13
14.5	cm/5¾"	05-1404-14
15.5	cm/6"	05-1404-15
16.0	cm/6¼"	05-1404-16
18.0	cm/7"	05-1404-18
20.0	cm/8"	05-1404-20



Curved

Standard
Fig. 2

05-1405-10
05-1405-11
05-1405-13
05-1405-14
05-1405-15
05-1405-16
05-1405-18
05-1405-20



Curved

Standard
Fig. 3

05-1406-10
05-1406-11
05-1406-13
05-1406-14
05-1406-15
05-1406-16
05-1406-18
05-1406-20

SCISSORS



Graziol

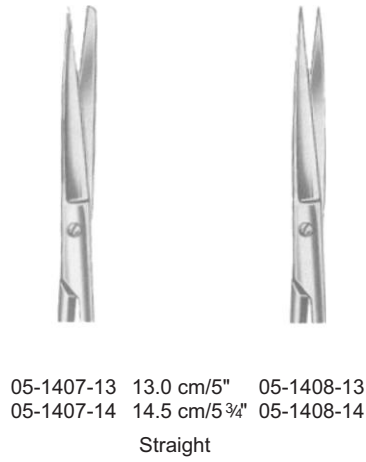

05-1407-13 13.0 cm/5" 05-1408-13
 05-1407-14 14.5 cm/5 3/4" 05-1408-14
 Straight



Graziol

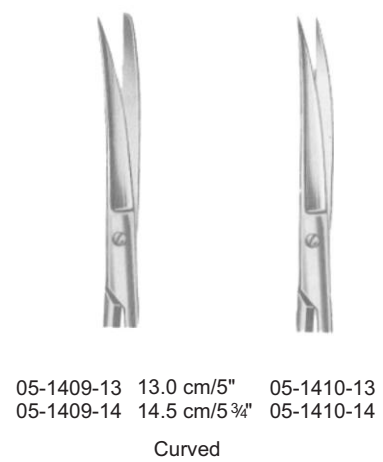

05-1409-13 13.0 cm/5" 05-1410-13
 05-1409-14 14.5 cm/5 3/4" 05-1410-14
 Curved



Straight

05-1411-14



Curved

Deaver

14.5cm/5 3/4"

05-1412-14



Straight

05-1413-15



Curved

Mixer

15.5cm/6"

05-1414-15

SCISSORS



Lexer
Straight
05-1415-16
16 cm/6¼"



Lexer
Curved
05-1416-16
16 cm/6¼"



Lexer-Fine
Straight
05-1417-16
16 cm/6¼"



Lexer-Fine
Curved
05-1418-16
16 cm/6¼"

Incision Scissors



05-1419-13 13.0 cm/5¼"
05-1419-14 14.5 cm/5¾"



05-1420-15
15.5 cm/6"



Richter
05-1421-14
14.5 cm/5¾"



Richter
05-1422-14
14.5 cm/5¾"

SCISSORS



Mayo
Straight

05-1423-14 14.5 cm/5 3/4"
 05-1423-15 15.0 cm/6"
 05-1423-17 17.0 cm/6 3/4"
 05-1423-19 19.0 cm/7 1/2"
 05-1423-23 23.0 cm/9"



Mayo
Curved

05-1424-14 14.5 cm/5 3/4"
 05-1424-15 15.0 cm/6"
 05-1424-17 17.0 cm/6 3/4"
 05-1424-19 19.0 cm/7 1/2"
 05-1424-23 23.0 cm/9"



Mayo-Stille
Straight

05-1425-15 15 cm/6"
 05-1425-17 17 cm/6 3/4"
 05-1425-19 19 cm/7 1/2"
 05-1425-21 21 cm/8 1/4"



Mayo-Stille
Curved

05-1426-15 15 cm/6"
 05-1426-17 17 cm/6 3/4"
 05-1426-19 19 cm/7 1/2"
 05-1426-21 21 cm/8 1/4"



Fergusson
05-1427-18
18 cm/7"



New Suture
05-1428-14
14.5 cm/5 3/4"



Straight

Mayo-Noble
05-1429-17
17 cm/6 3/4"



Curved

Mayo-Noble
05-1430-17
17 cm/6 3/4"

SCISSORS

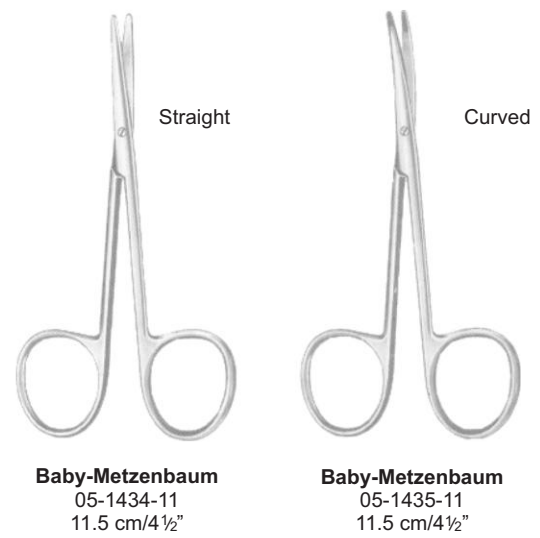
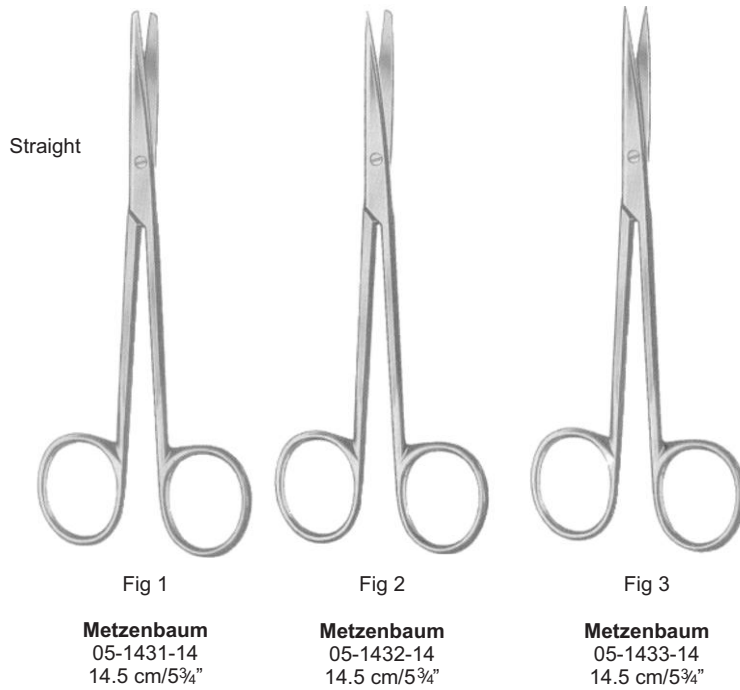

SCISSORS

Straight



	Metzenbaum-Fine	Metzenbaum	Metzenbaum	Metzenbaum
18 cm/7"	05-1440-18	05-1441-18	05-1442-18	05-1443-18
20 cm/8"	05-1440-20	05-1441-20	05-1442-20	05-1443-20
23 cm/9"	05-1440-23	05-1441-23	05-1442-23	05-1443-23
25 cm/10"	05-1440-25	05-1441-25	05-1442-25	05-1443-25
28 cm/11"	05-1440-28	05-1441-28	05-1442-28	05-1443-28
30 cm/12"	05-1440-30	05-1441-30	05-1442-30	05-1443-30



Sims
 05-1444-20 20 cm/8"
 05-1444-23 23 cm/9"

Straight
 05-1445-20 20 cm/8"
 05-1445-23 23 cm/9"
 05-1446-20
 05-1446-23

Sims
 05-1447-20 20 cm/8"
 05-1447-23 23 cm/9"

Curved
 05-1448-20 20 cm/8"
 05-1448-23 23 cm/9"
 05-1449-20
 05-1449-23

SCISSORS



Curved

Dubois
05-1450-27 27 cm/10 1/2"



Dubois
05-1451-27 27 cm/10 1/2"



Straight

Doyen
05-1452-16 16 cm/6 1/4"
05-1452-18 18 cm/7"

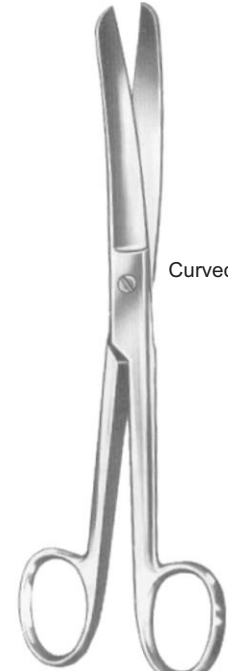

Curved

Doyen
05-1453-16 16 cm/6 1/4"
05-1453-18 18 cm/7"



Kelly
05-1454-16 16 cm/6 1/4"
05-1454-18 18 cm/7"



Kelly
05-1455-16 16 cm/6 1/4"
05-1455-18 18 cm/7"

SCISSORS



Fig. 1
05-1456-12



Fig. 2
05-1457-12

Straight

12cm/4¾"



Fig. 3
05-1458-12



Fig. 1
05-1459-12



Fig. 2
05-1460-12

Curved

12cm/4¾"



Fig. 3
05-1461-12

Saw Edge

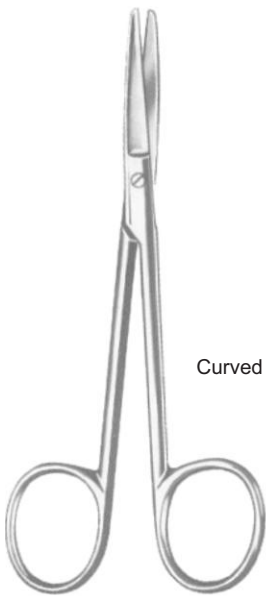

Wagner
12cm/4¾"

Curved



Fig. 1
05-1462-12



Fig. 2
05-1463-12



Fig. 3
05-1464-12



Fig. 4
05-1465-12



Fig. 1
05-1466-12



Fig. 2
05-1467-12



Fig. 3
05-1468-12



Fig. 4
05-1469-12

Straight



05-1470-12
11.5cm/4½"

Curved



05-1471-12
11.5cm/4½"

SCISSORS



Straight

Brophy (Sullivan)
05-1472-14

14.5 cm/5 3/4"

05-1473-14



Curved



Straight

Reynolds
05-1474-15
05-1474-18

15 cm/6"
18 cm/7"



Curved

05-1475-15
05-1475-18

Enucleation Scissors

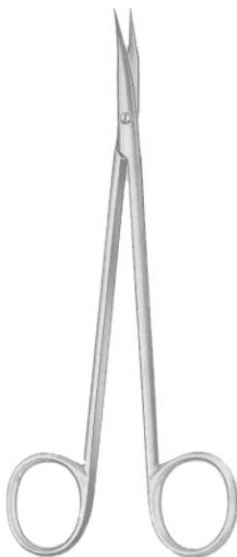

Jameson
05-1476-15
15cm/6"



05-1477-12



05-1478-12



Landolt
12.5cm/5"



05-1479-12



05-1480-12

SCISSORS



9.0 cm/3½"	05-1481-09	05-1482-09	05-1483-09	05-1484-09	Standard	05-1485-09
10.5 cm/4¼"	05-1481-10	05-1482-10	05-1483-10	05-1484-10		05-1485-10
11.5 cm/4½"	05-1481-11	05-1482-11	05-1483-11	05-1484-11		05-1485-11

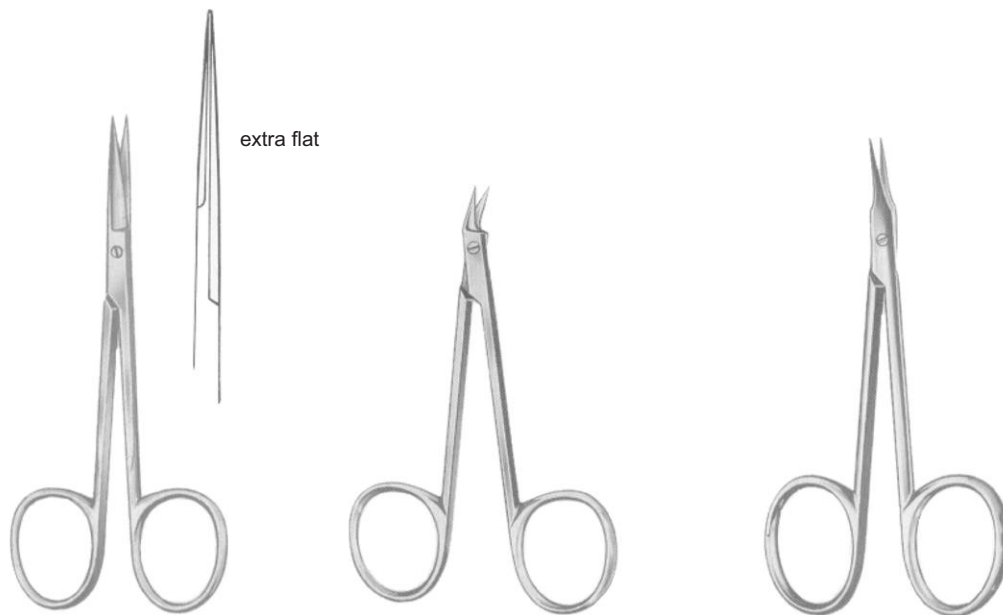

05-1486-10
10cm/4"

05-1487-09
9cm/3½"

Walton
05-1488-10
10cm/4"

SCISSORS

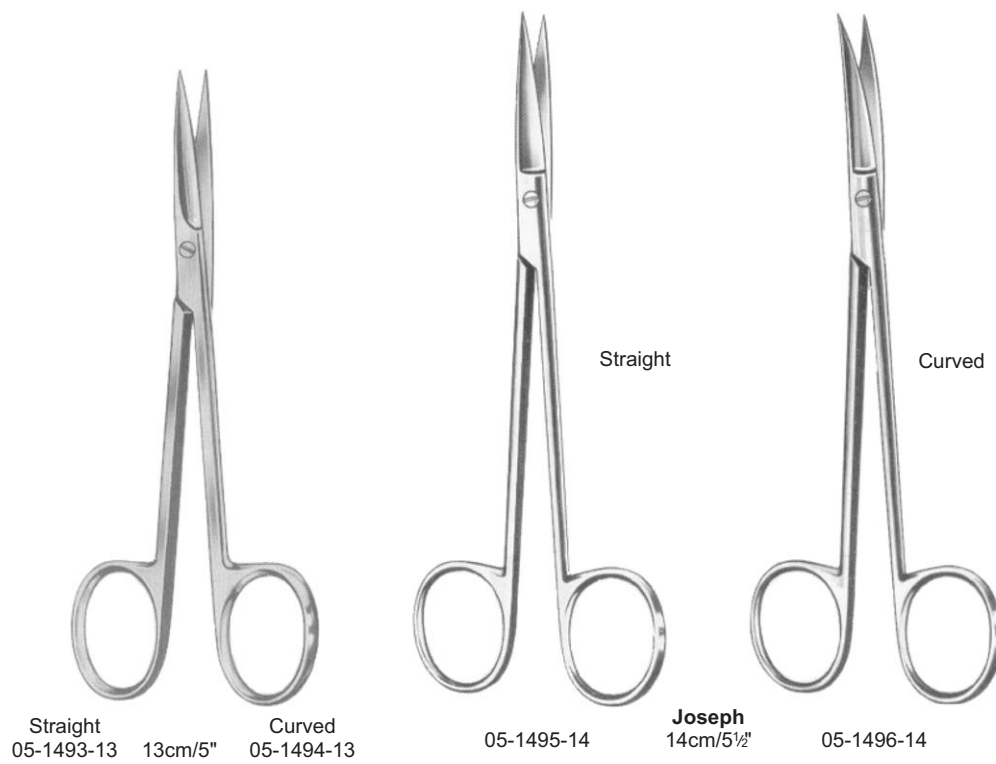
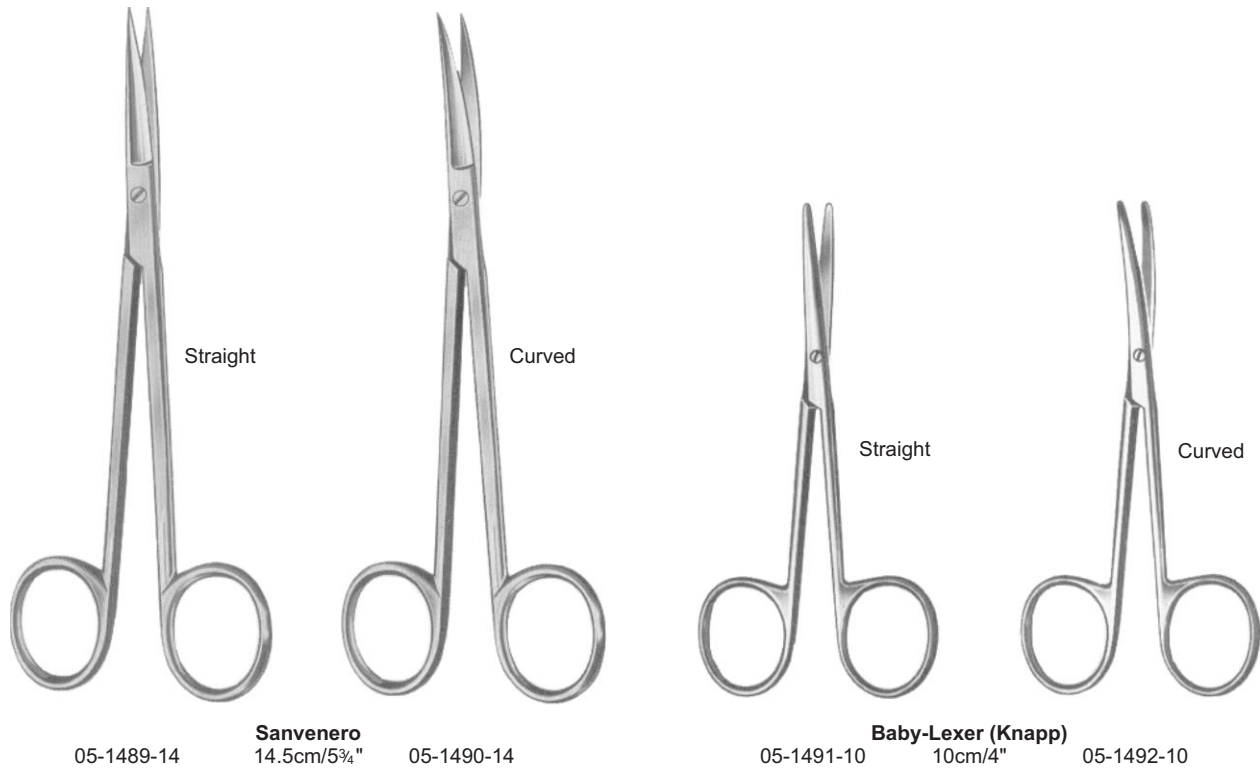

SCISSORS

**Kilner (Ragnell)**

05-1497-12 12cm/4 ¾"
05-1497-13 13cm/5"
05-1497-15 15cm/6"



05-1498-14
14.5cm/5¾"

Coronary Scissors



05-1499-11
11.5cm/4½"



Potts-Smith
05-1500-19
19.5cm/7¾"



De Bakey
05-1501-15
15.5cm/6"



De Bakey
05-1502-15
15.5cm/6"



Favaloro
05-1503-15
15cm/6"

SCISSORS

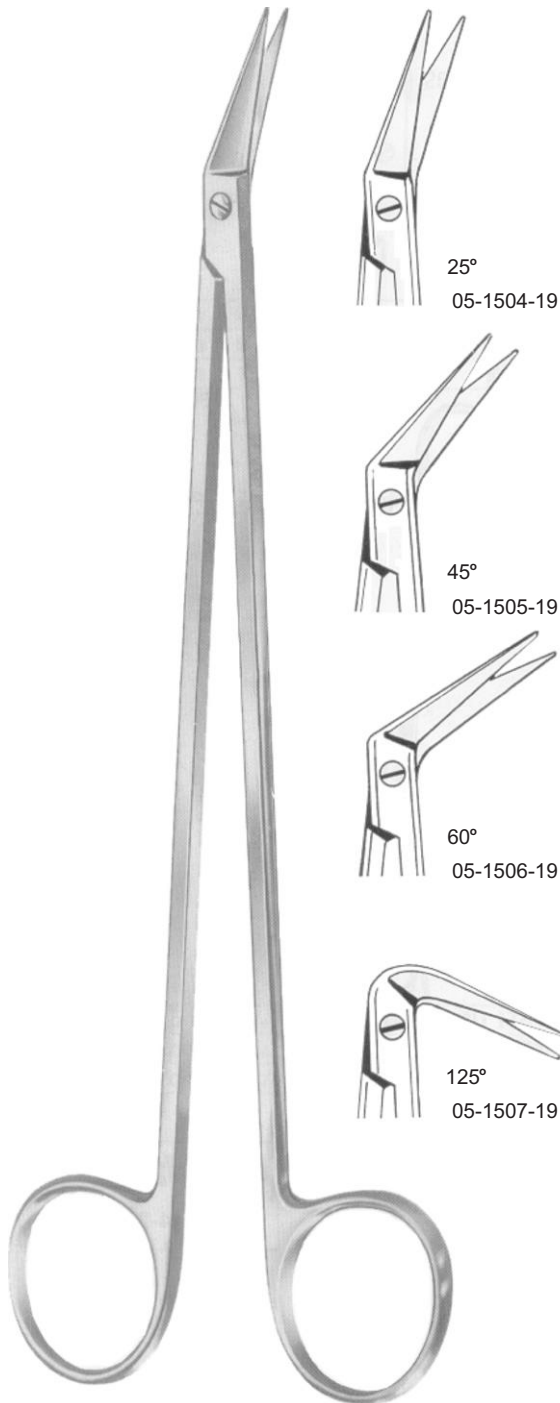

Potts-Smith
19cm/7 1/2"

25°
05-1504-19

45°
05-1505-19

60°
05-1506-19

125°
05-1507-19



McIndoe
05-1508-19
19cm/7 1/2"



Potts-Smith
05-1509-19
19cm/7 1/2"

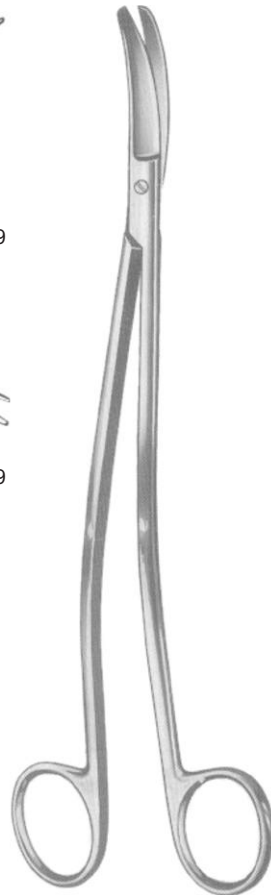

Satinsky
05-1510-24
24.5cm/10"



Klingenberg-Loth
05-1511-23
23cm/9"

SCISSORS



De Bakey
18cm/7"

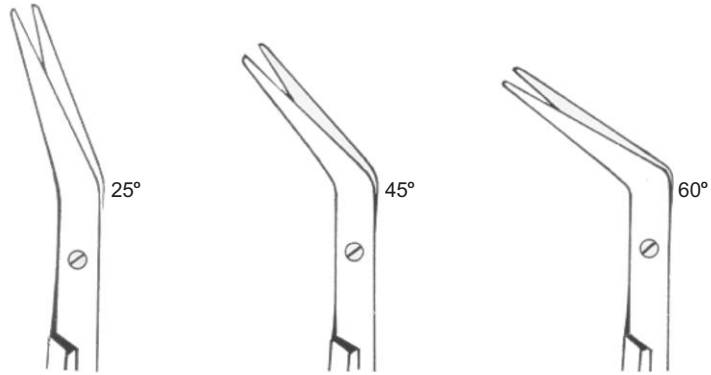

cm	In			
16.0cm	6 1/4"	05-1512-16	05-1513-16	05-1514-16
23.0cm	9"	05-1512-23	05-1513-23	05-1514-23
28.0cm	11"	05-1512-28	05-1513-28	05-1514-28

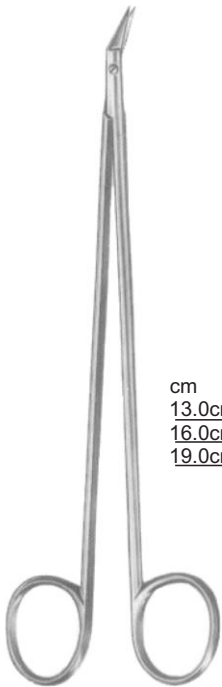

Baby-Hegemann
13.5cm/5 1/4"
Hegemann (Diethrich)
16cm/6 1/4"
19cm/7 1/2"

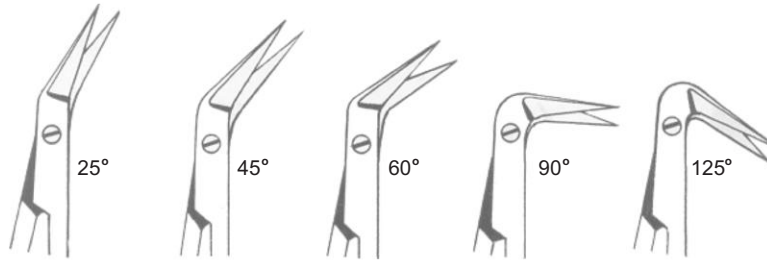

cm	In					
13.0cm	5 1/4"	05-1515-13	05-1516-13	05-1517-13	05-1518-13	05-1519-13
16.0cm	6 1/4"	05-1515-16	05-1516-16	05-1517-16	05-1518-16	05-1519-16
19.0cm	7 1/2"	05-1515-19	05-1516-19	05-1517-19	05-1518-19	05-1519-19

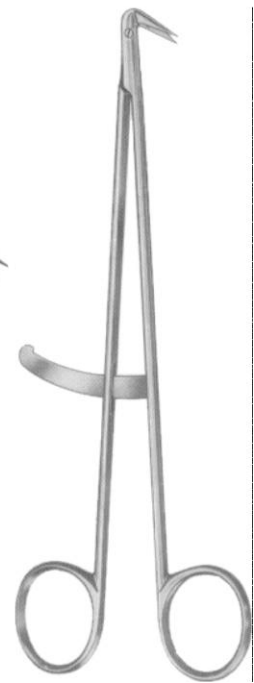

Hegemann (Diethrich)
05-1520-19
19cm/7 1/2"

SCISSORS

Nerve Dissecting Scissors



05-1521-15
15cm/6"

Tonsil Scissors



Bottcher
05-1522-18
18cm/7"



Prince
05-1523-17
17.5cm/7"

Arteriotomy Scissors



Tonnis-Adson-Fine
05-1524-17
17.5cm/7"



Straight

Tonnis
05-1525-18
18cm/7"

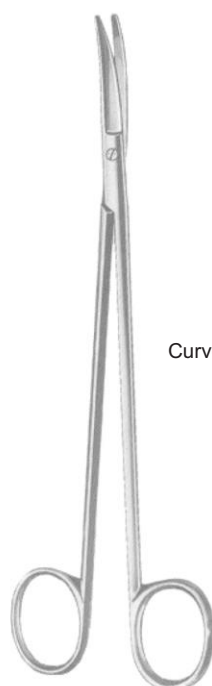

Curved

Tonnis
05-1526-18
18cm/7"



Tonnis-Adson
05-1527-17
17.5cm/7"

SCISSORS

Tonsil Scissors



Good
05-1528-19
19 cm/7 1/2"

Lobectomy Scissors



Crafoord
05-1529-30
30 cm/12"



Finochietto
05-1530-27
27 cm/10 1/2"

Enterotomy Scissors



05-1531-21
21 cm/8 1/4"



05-1532-21
21 cm/8 1/4"



05-1533-21
21 cm/8 1/4"

SCISSORS



Busch
 05-1534-13 13 cm/5"
 05-1534-16 16 cm/6 ¼"



Schumacher
 05-1535-16
 16 cm/6 ¼"



Mod. USA
 05-1536-10
 10.5 cm/4 ¼"



Braun-Stadler
 05-1537-14
 14 cm/5 ½"

Braun-Stadler
 05-1538-22
 22 cm/8 ½"



Straight
 05-1539-12

12cm/4¾"



Curved
 05-1540-12

SCISSORS



Heymann
05-1541-18
18 cm/7"



Heymann
05-1542-19
19.5 cm/7¾"



Knight
05-1543-18
18 cm/7"



Fomon
05-1544-13
13 cm/5"



Fomon
05-1545-13
13.5 cm/5¼"



Fomon
05-1546-13
13.5 cm/5¼"



Cottle
05-1547-16
16 cm/6¼"



Halle
05-1548-19
19 cm/7¼"

SCISSORS



Strully
05-1549-22 22 cm/8¾" 05-1550-22



Dandy
05-1551-22
17 cm/6¾"

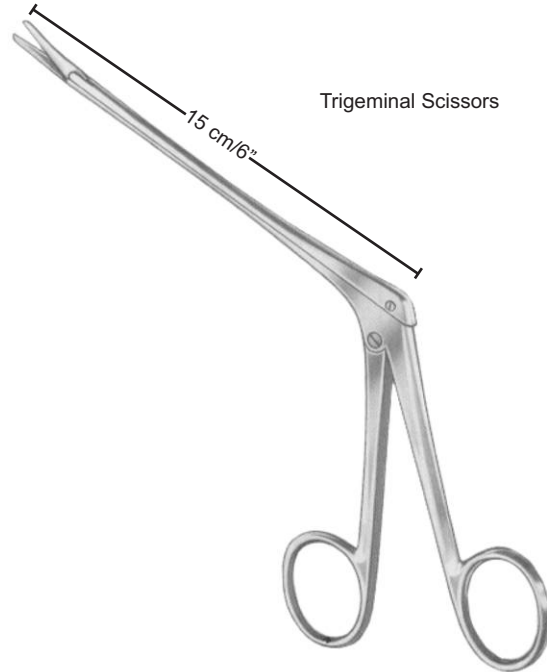

Trigeminal Scissors

Olivecrona
05-1552-15



Straight

05-1553-11

05-1554-11

Curved

05-1555-11

05-1556-11

11.5cm/4½"

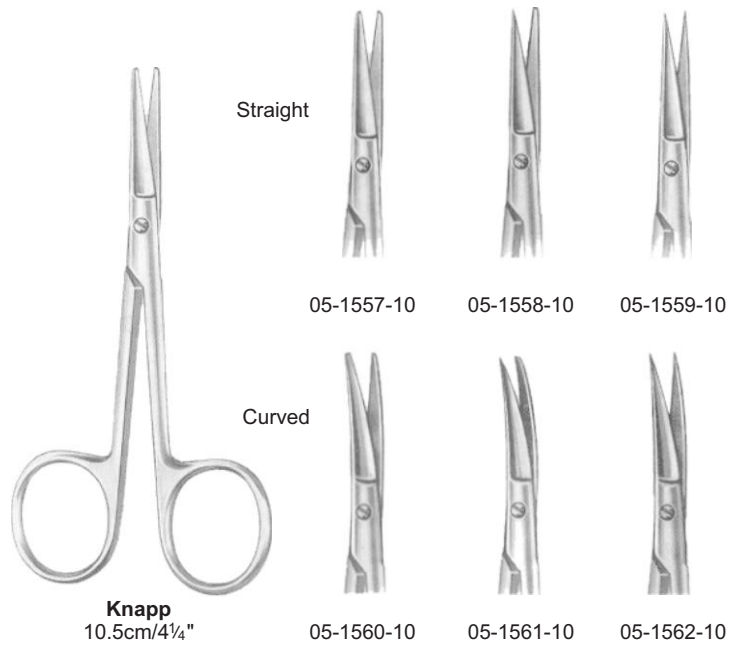

Straight

05-1557-10

05-1558-10

05-1559-10

Curved

Knapp
10.5cm/4¼"

05-1560-10

05-1561-10

05-1562-10

SCISSORS

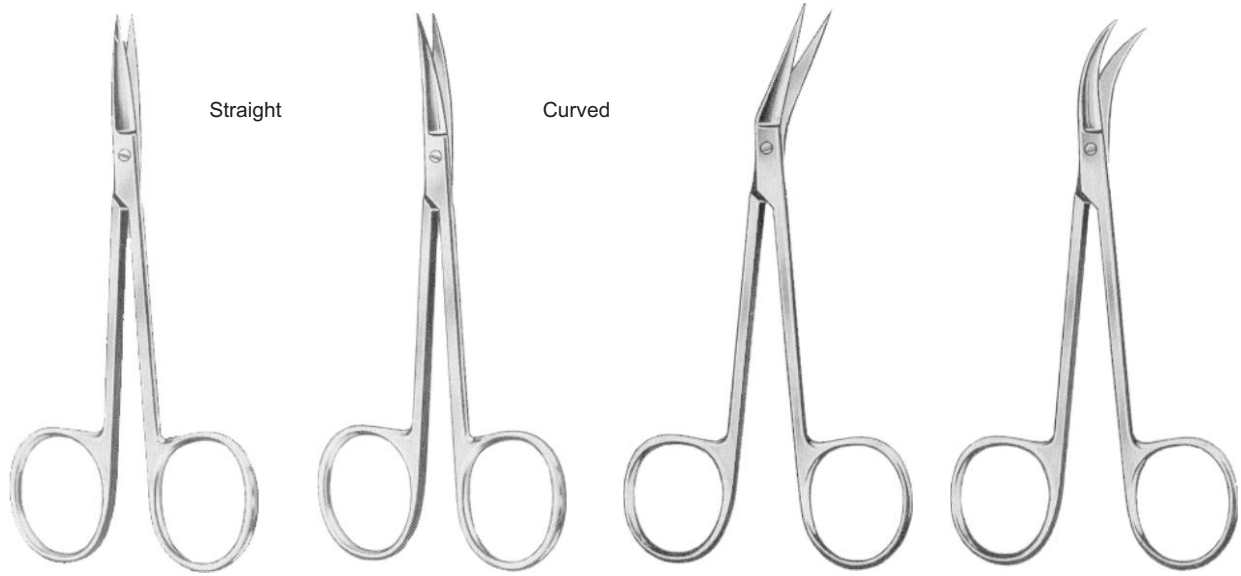

Standard

9.0 cm/3½"	05-1563-09	05-1564-09	05-1565-09	05-1566-09
10.5 cm/4¼"	05-1563-10	05-1564-10	05-1565-10	05-1566-10
11.5 cm/4½"	05-1563-11	05-1564-11	05-1565-11	05-1566-11

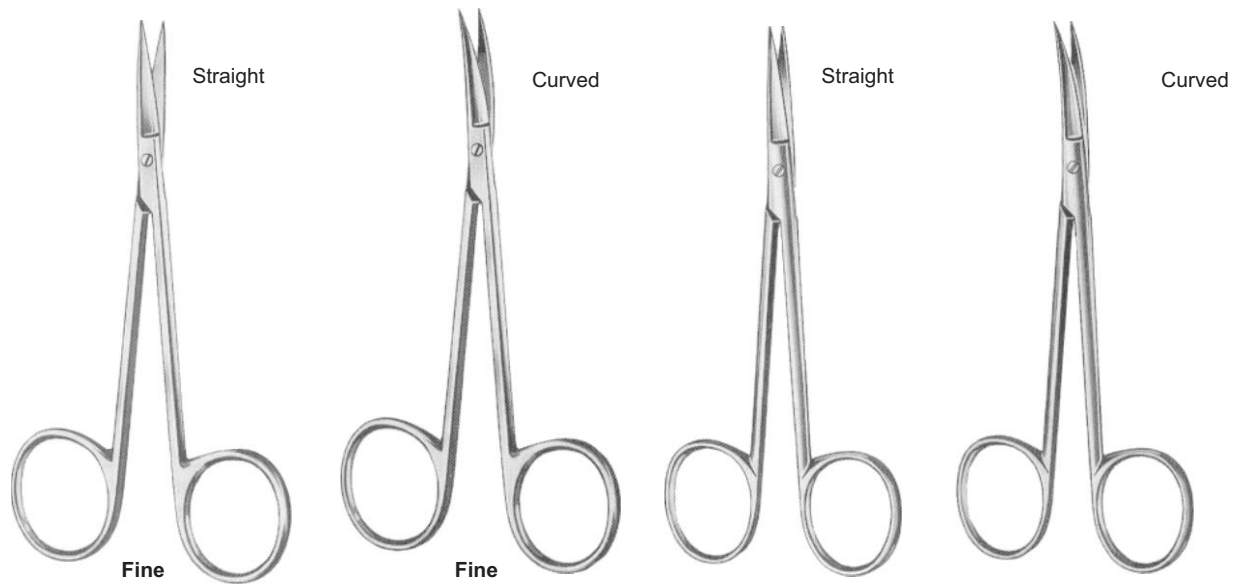

Fine

Fine

9.0cm/3¾"			05-1569-09	05-1570-09
10.5cm/4¼"	05-1567-10	05-1568-10	05-1569-10	05-1570-10
11.5cm/4½"	05-1567-11	05-1568-11	05-1569-11	05-1570-11

SCISSORS



Straight
Fine

9.5 cm/3¾"	05-1571-09
10.5 cm/4¼"	05-1571-10
11.5 cm/4½"	05-1571-11



Curved
Fine

05-1572-09
05-1572-10
05-1572-11



Straight

05-1573-10

Curved

10cm/4" 05-1574-10

Tenotomy Scissors



10.5cm/4¼"
11.5cm/4½"



Pointed

Straight
05-1575-10
05-1575-11



Curved
05-1576-10
05-1576-11



Blunt

Straight
05-1577-10
05-1577-11



Curved
05-1578-10
05-1578-11

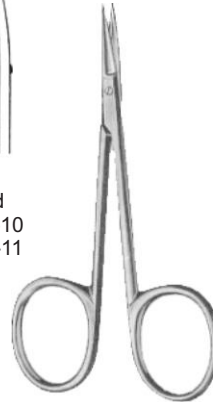

Straight
05-1579-08



Bonn
8cm/3¼" Curved
05-1580-08

SCISSORS



Graefe
05-1581-10
10.5cm/4¼"



Wilmer
05-1582-10
10cm/4"



05-1583-11

11.5cm/4½"



05-1584-11



La Grange
05-1585-11
11.5cm/4½"



Chadwick
05-1586-11
11cm/4½"

SCISSORS

Neurosurgical Scissors

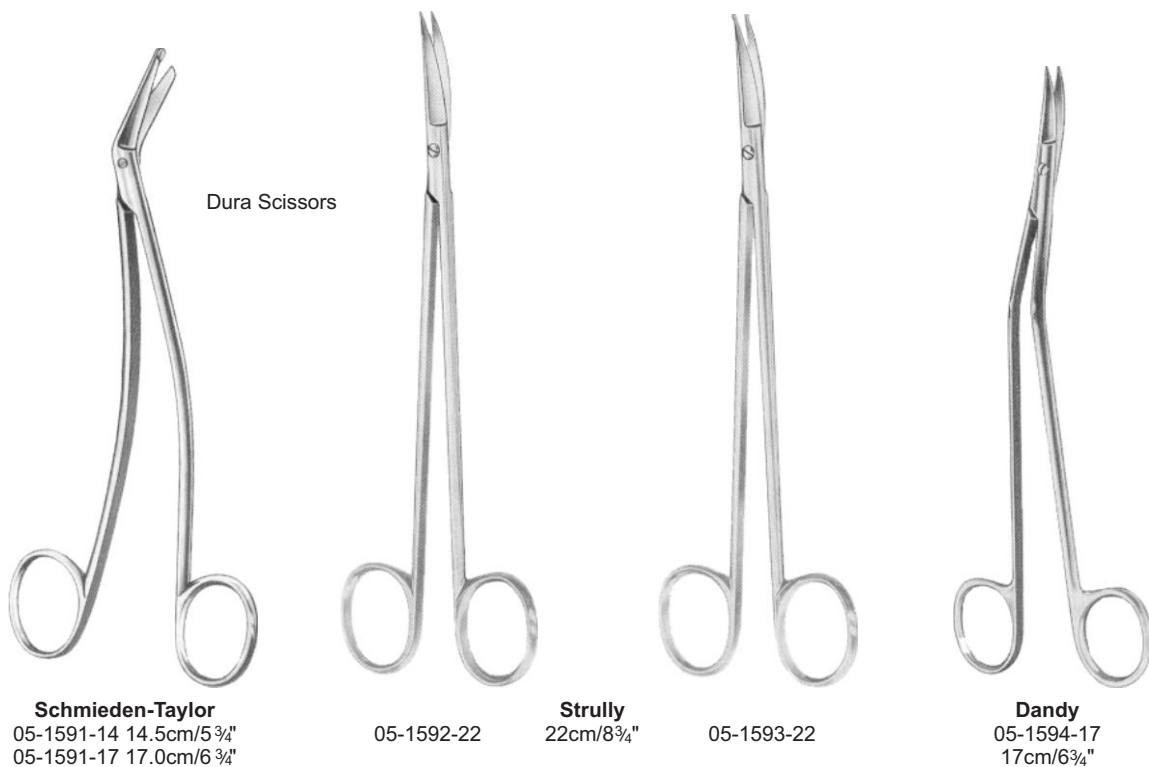
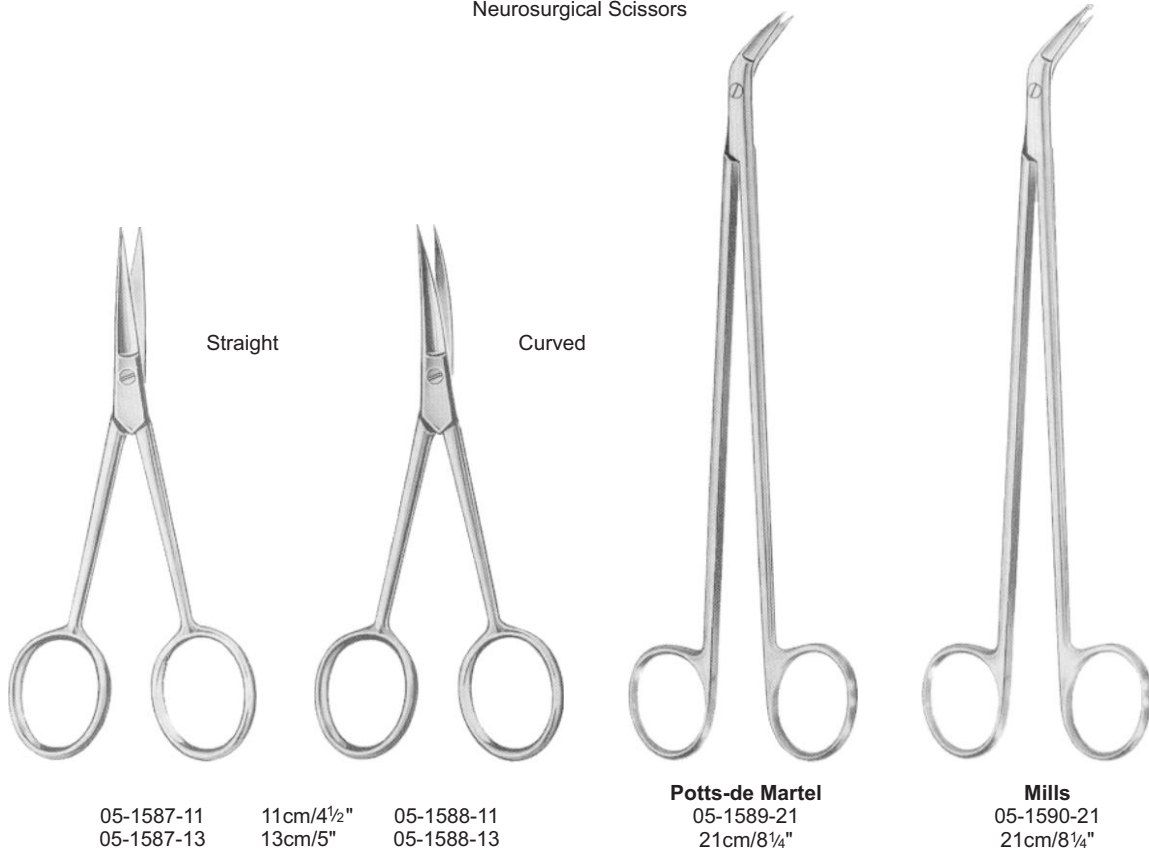

SCISSORS



Littauer
05-1595-14
14cm/5½"



Spencer
05-1596-09
9cm/3½"



Spencer
05-1597-10 10.5cm/4¼"
05-1597-12 12.0cm/4¾"



Spencer-Fine
05-1598-11 11.5cm/4½"
05-1598-16 16cm/6¼"



Shortbent
05-1599-09
9cm/3½"



Northbent
05-1600-12
12.5cm/5"



Spencer
05-1601-11
11.5cm/4½"



Littler
05-1602-11
11.5cm/4½"

SCISSORS



Heath
05-1603-15
15cm/6"



05-1604-10
10cm/4"



Eiselsberg
05-1605-11
11.5cm/4½"



Schoemaker-Loth
05-1606-12
12.5cm/5"

Wire Cutting Scissors

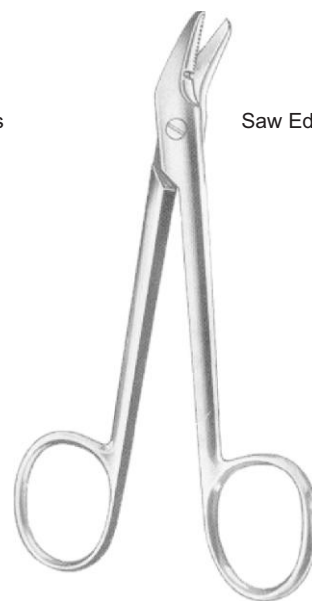

Universal
05-1607-12
12cm/4¾"

Saw Edge

SCISSORS

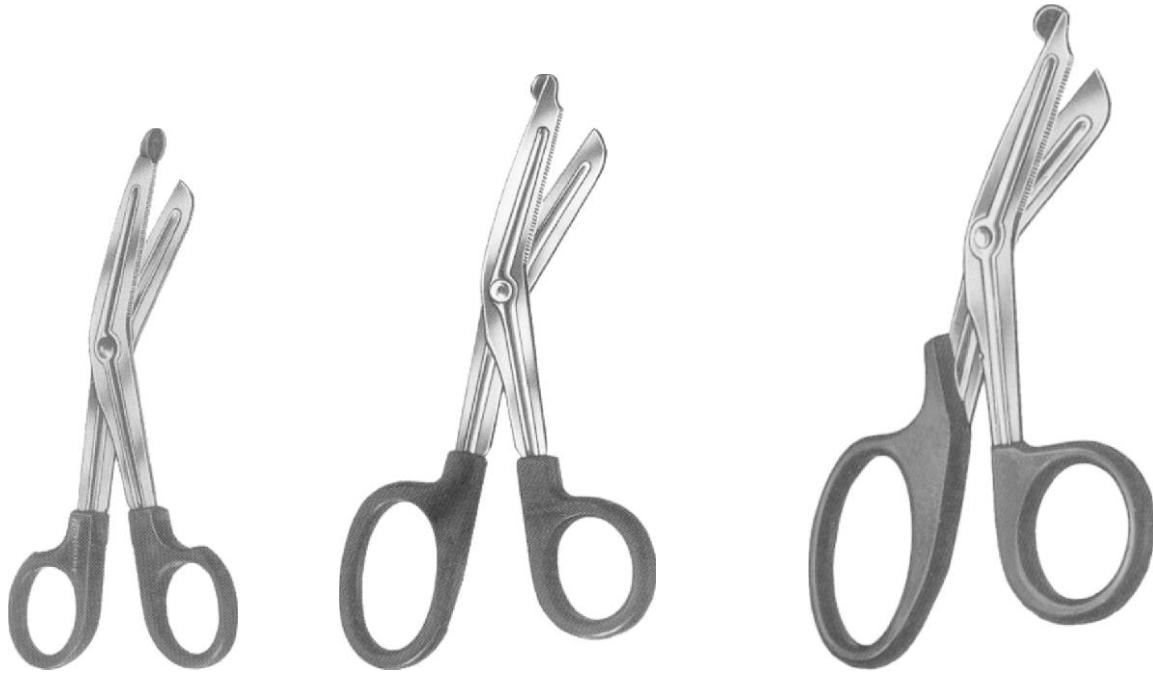

	Universal	Universal	Universal
Black	05-1608-01	05-1609-01	05-1610-01
Blue	05-1608-02	05-1609-02	05-1610-02
Red	05-1608-03	05-1609-03	05-1610-03
Green	05-1608-04	05-1609-04	05-1610-04

14.5 cm/5¾"

16 cm/6¼"

18 cm/7"



Smith
05-1611-17
17.5 cm/7"

Harvey
05-1612-12
12.5 cm/5"

Schuknecht
05-1613-10
10 cm/4"

05-1614-13 13 cm/5"
05-1614-15 15 cm/6"

Nail Splinting Scissors

Saw edge

Saw edge

SCISSORS



Lister

05-1615-09 09.0 cm/3 1/2"
05-1615-11 11.5 cm/4 1/2"
05-1615-14 14.0 cm/5 1/2"
05-1615-15 15.5 cm/6"
05-1615-18 18.0 cm/7"
05-1615-20 20.0 cm/8"



Lister

05-1616-18 18.5 cm/7 1/4"
05-1616-21 21.0 cm/8 1/4"



Lister-Excentric

05-1617-16 16 cm/6 1/4"
05-1617-19 19 cm/7 1/2"



Esmarch

05-1618-20 20 cm/8"
05-1618-22 22 cm/8 3/4"



Bergmann

05-1619-23 23 cm/9"



Lorenz

05-1620-23 23 cm/9"

SCISSORS



Saw edge

05-1621-17
 17 cm/6¾"



Lange
 05-1622-18
 18 cm/7"



Bruns
 05-1623-24 24 cm/9½" Saw edge
 05-1624-24 24 cm/9½" Smooth
 05-1625-24 24 cm/9½" TC

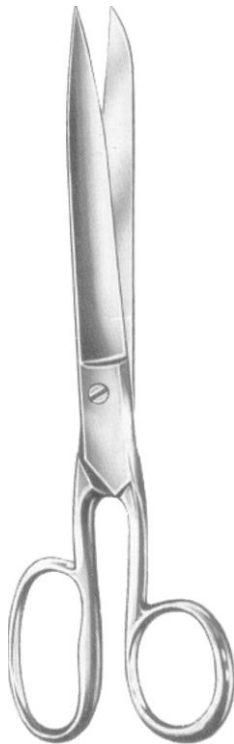

Smith (Mod. USA)
 05-1626-18 18 cm/7"
 05-1626-20 20 cm/8"
 05-1626-23 23 cm/9"



Knowles
 05-1627-14
 14 cm/5½"



Knowles
 05-1628-14
 14 cm/5½"



05-1629-13
 13 cm/5"

SCISSORS



05-1630-20
20 cm/8"



Seutin
05-1631-23
23 cm/9"



05-1632-23
23 cm/9"



Collin
05-1633-22
22 cm/8¾"



Gluck
05-1634-22
22 cm/8¾"



Stille
05-1635-21
21 cm/8¼"



Stille
05-1636-24
24 cm/9½"



Stille
05-1637-23 23 cm/9"
05-1637-26 26 cm/10¼"
05-1637-37 37 cm/14½"

SCISSORS

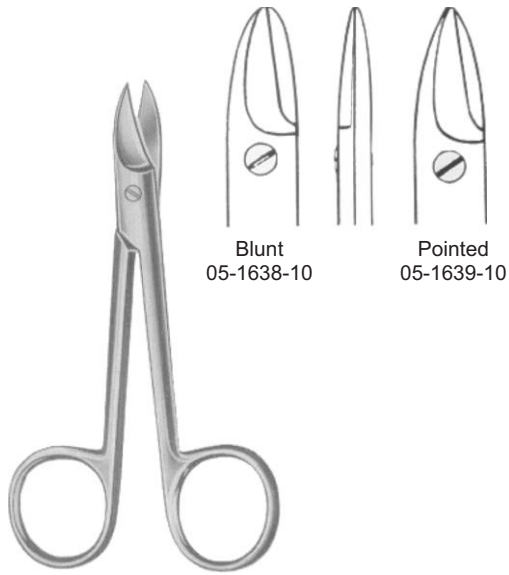

Beebee
 Straight
 10.5 cm/4 1/4"

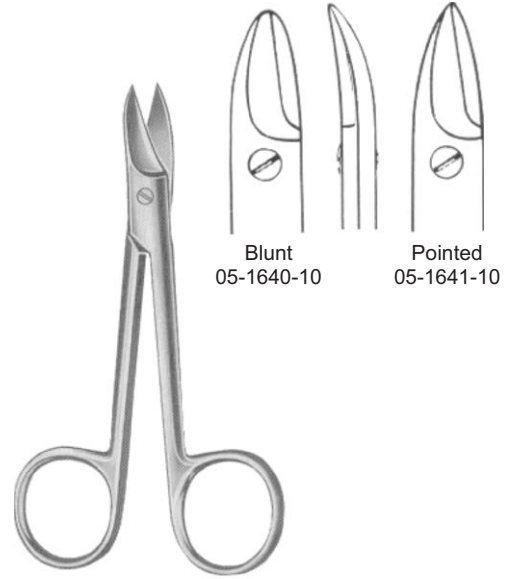

Beebee
 Curved
 10.5 cm/4 1/4"



05-1642-10
 10.5 cm/4 1/4"

Beebee
 12 cm/4 3/4"

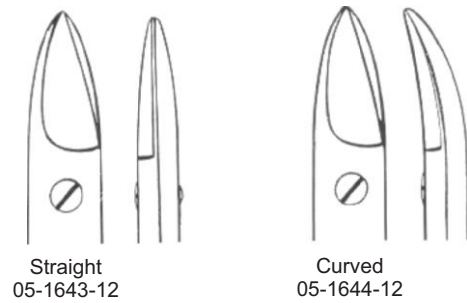

Straight
 05-1643-12

Curved
 05-1644-12

SCISSORS



Goldmann-Fox
05-1645-13
13 cm/5"

Saw edge



Goldmann-Fox
05-1646-13
13 cm/5"



Niro
05-1647-14
14 cm/5 1/2"



Goldmann-Fox
(Spezial)
05-1648-13
13 cm/5"

Saw edge



05-1649-11
11.5 cm/4 1/2"

Fine



Quinby
05-1650-12
12 cm/4 3/4"



Quinby
05-1651-12
12 cm/4 3/4"

SCISSORS



Dean
 05-1652-17
 17 cm/6¾"



Dean
 05-1653-17
 17 cm/6¾"



Locklin
 05-1654-16
 16.5 cm/6½"



Locklin
 05-1655-16
 16.5 cm/6½"



Sullivan
 05-1656-14
 14.5 cm/5¾"



Sullivan
 05-1657-14
 14.5 cm/5¾"



Neumann
 05-1658-12
 12.5 cm/5"



La Grange
 05-1659-11
 11.5 cm/4½"

SCISSORS



05-1660-11 **Standard** 11.5 cm/4½" 05-1661-11 05-1662-11 **Standard** 11.5 cm/4½" 05-1663-11 **Chadwick** 05-1664-11 11.5 cm/4½"

Nail scissors

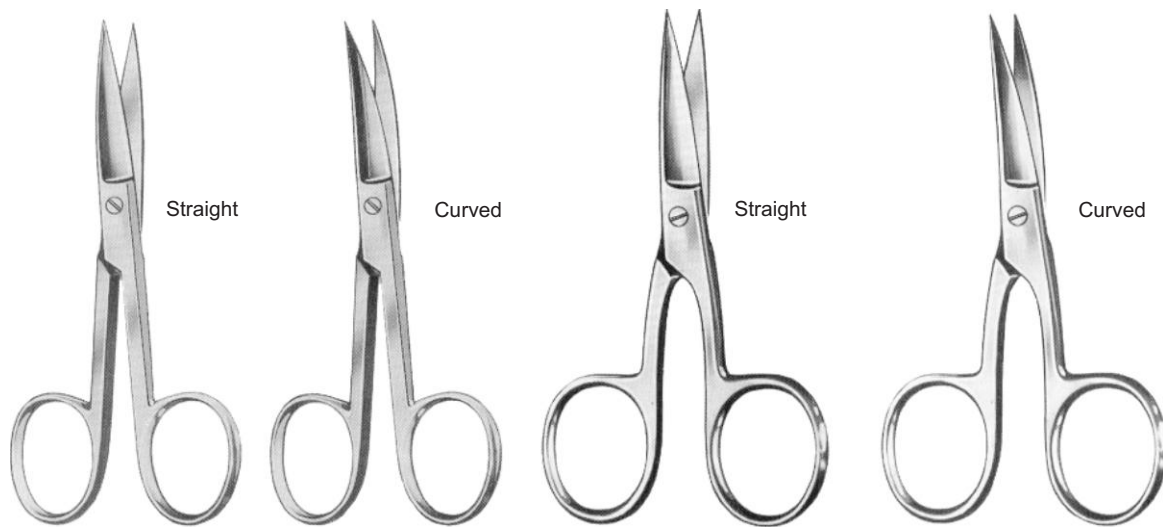

09.0 cm/3½" 05-1665-09 05-1666-09 05-1667-09 05-1668-09
10.5 cm/4¼" 05-1665-10 05-1666-10 05-1667-10 05-1668-10

SCISSORS

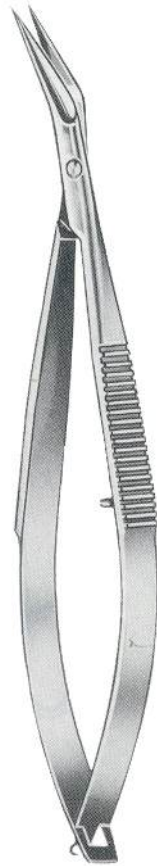

Fig. 1

Fig. 2

Fig. 3

Noyes
 Fig.1 05-1669-01
 Fig.2 05-1669-02
 Fig.3 05-1669-03
 12 cm/4¾"



Noyes
 05-1670-12
 12 cm/4¾"

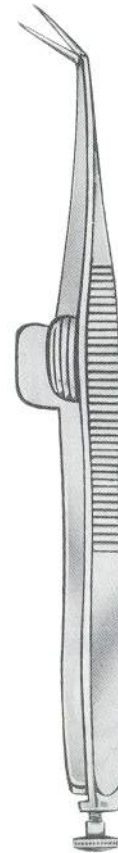

Wecker
 11.5 cm/4½"



05-1671-01

05-1671-02



Barraquer
 05-1672-05
 5.5 cm/2¼"



05-1673-09
 9 cm/3½"



05-1674-09



05-1675-09



05-1676-09



05-1677-09



05-1678-09

SCISSORS



Straight

Vannas
05-1679-08
8 cm/3¼"

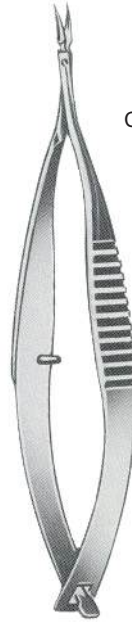

Curved

Vannas
05-1680-08
8 cm/3¼"

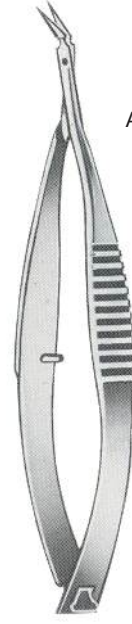

Angular

Vannas
05-1681-08
8 cm/3¼"

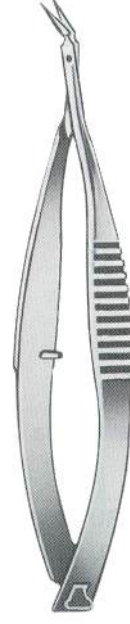

Vannas
05-1682-08
8 cm/3¼"



Straight

05-1683-08
8.5 cm/3¼"



Curved

05-1684-08
8.5 cm/3½"

Vannas Mod, Tübingen

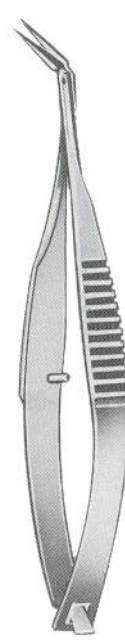

Angular

05-1685-08
8.5 cm/3½"

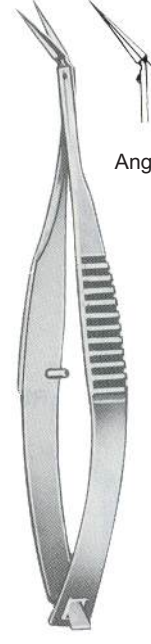

Angular

05-1686-08
8.5 cm/3½"

SCISSORS

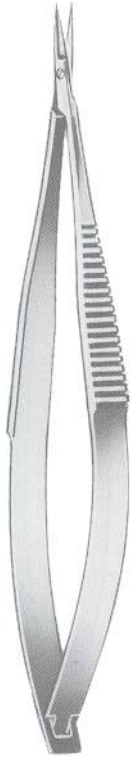

05-1687-10
10 cm/4"



05-1688-10
10 cm/4"



Castroviejo
05-1689-10
10 cm/4"



Castroviejo
05-1690-10
10 cm/4"



Aebli
05-1691-10
10 cm/4"



Castroviejo
05-1692-10
10 cm/4"



Castroviejo
05-1693-10
10 cm/4"

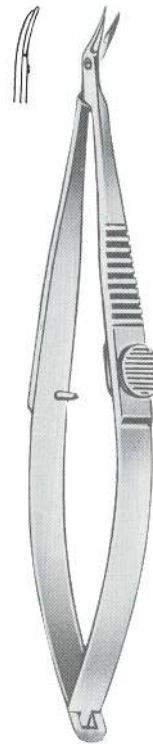

Troutman-Barraquer
05-1694-10
10 cm/4"

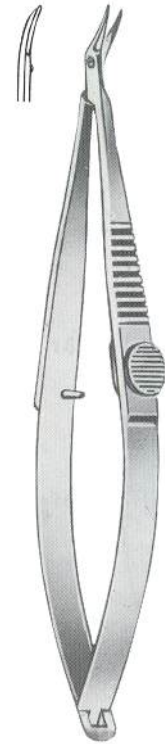

Troutman-Barraquer
05-1695-10
10 cm/4"

SCISSORS



Troutman
05-1696-10
10 cm/4"

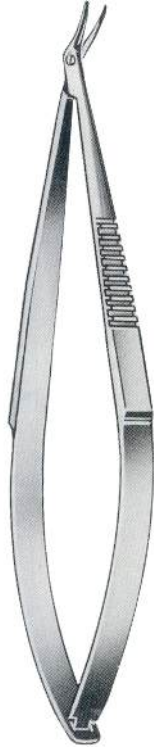

Troutman
05-1697-10
10 cm/4"

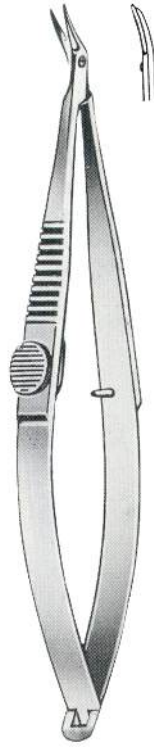

Katzin-Barraquer
05-1698-10
10 cm/4"

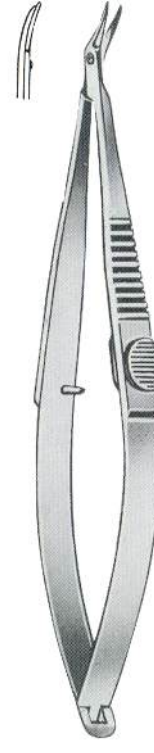

Katzin-Barraquer
05-1699-10
10 cm/4"

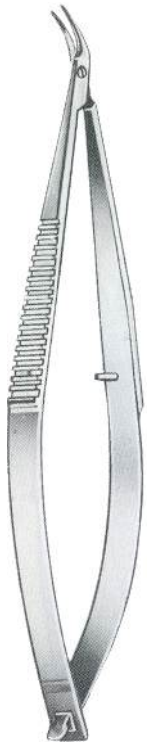

Katzin
05-1700-11
10 cm/4"

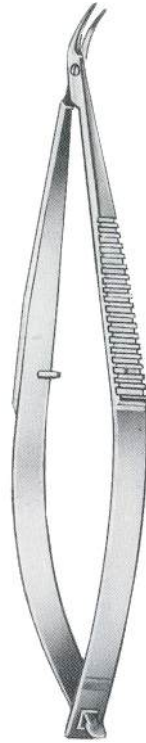

Katzin
05-1701-11
10 cm/4"



Westcott
05-1702-11
11 cm/4½"

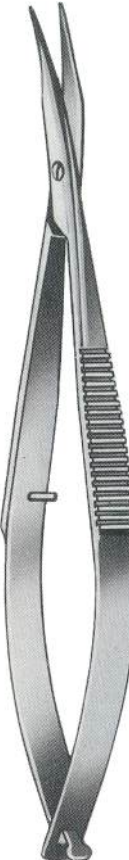

Westcott
05-1703-11
11 cm/4½"



Westcott
05-1704-11
11 cm/4½"

SCISSORS

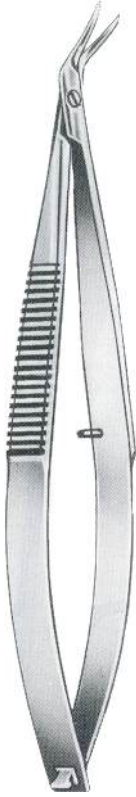

Castroviejo
 05-1705-10
 10 cm/4"

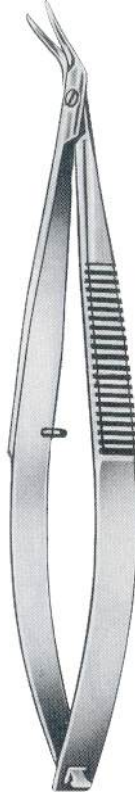

Castroviejo
 05-1706-10
 10 cm/4"

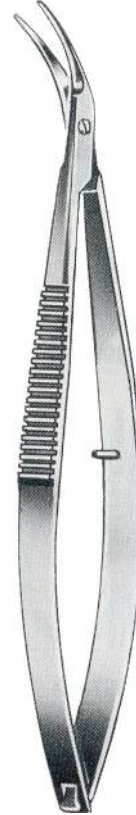

Castroviejo
 05-1707-11
 11.5 cm/4½"

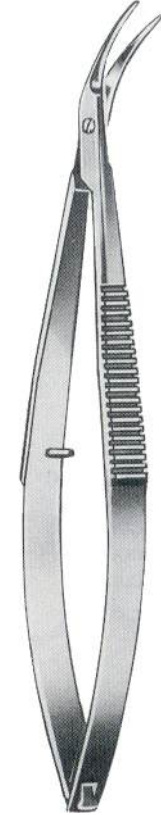

Castroviejo
 05-1708-11
 11.5 cm/4½"



Troutmann-Castroviejo
 05-1709-10
 10.5 cm/4¼"



Troutmann-Castroviejo
 05-1710-10
 10.5 cm/4¼"



14.5 cm/5¾"
 18.0 cm/7"

Straight
 05-1711-14
 05-1711-18

Curved
 05-1712-14
 05-1712-18

SCISSORS



Straight

05-1713-12 12.0 cm/4 3/4
 05-1713-16 16.0 cm/6 1/4
 05-1713-18 18.5 cm/7 1/4



Curved

05-1714-12 12.0 cm/4 3/4
 05-1714-16 16.0 cm/6 1/4
 05-1714-18 18.5 cm/7 1/4

Vannas

Straight

05-1715-12 12.0 cm/4 3/4
 05-1715-16 16.0 cm/6 1/4

Vannas

Curved

05-1716-12 12.0 cm/4 3/4
 05-1716-16 16.0 cm/6 1/4

SCISSORS

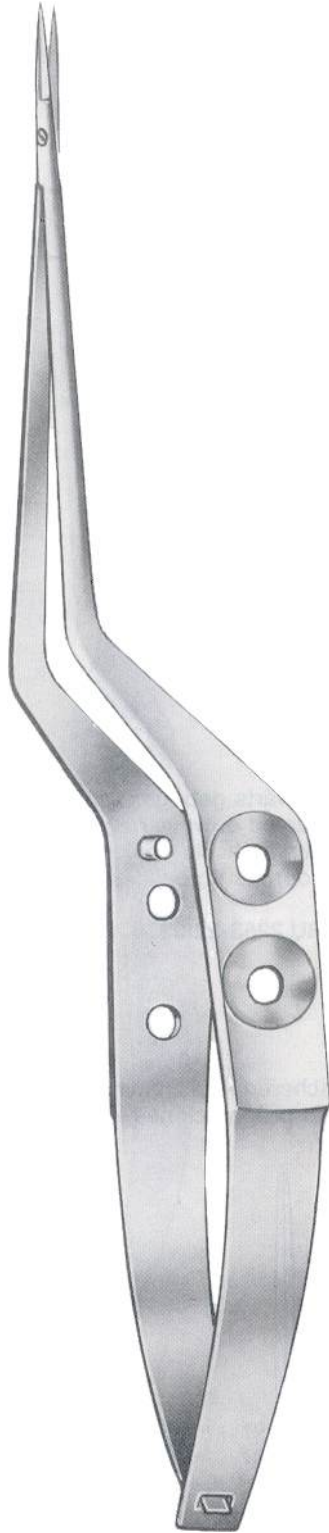

Yasargil

20.0cm/8"

16.5cm/6½"
 20.0cm/8"



Straight
 05-1717-16
 05-1717-20



Curved
 05-1718-16
 05-1718-20



Curved Downwards
 05-1719-20

Dissecting Scissors



Straight
 05-1720-20



Curved
 05-1721-20

SCISSORS



Yasargil

22.5cm/9"
24.5cm/9¾"



Straight
05-1722-22
05-1722-24



Curved
05-1723-22
05-1723-24



Curved Downwards
05-1724-22

22.5cm/9"

Dissecting Scissors



Straight
05-1725-22



Curved
05-1726-22

22.5cm/9"

SCISSORS



Jacobson
18cm/7"

05-1727-18



05-1730-19

05-1728-18



05-1731-19

05-1729-18



05-1732-19



05-1733-19



05-1734-19



19cm/7½"

SCISSORS

Vein Scissors

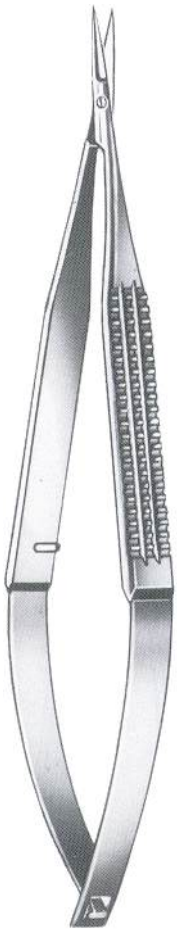

Straight
05-1735-12
12cm/4¾"

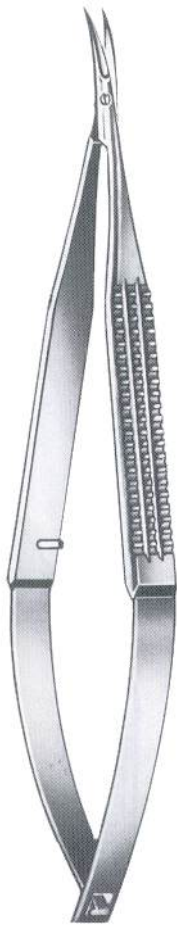

Curved
05-1736-12
12cm/4¾"

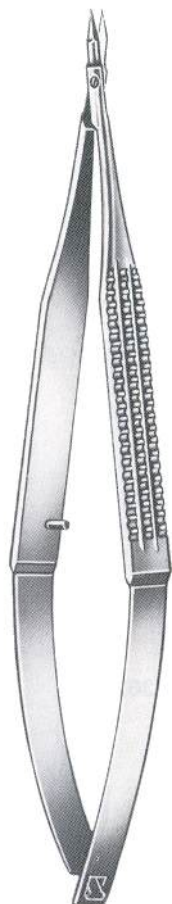

Straight
05-1737-12
12cm/4¾"

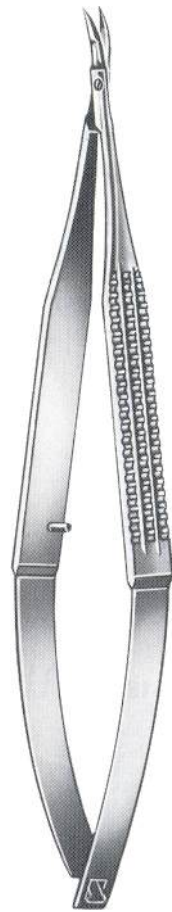

Curved
05-1738-12
12cm/4¾"

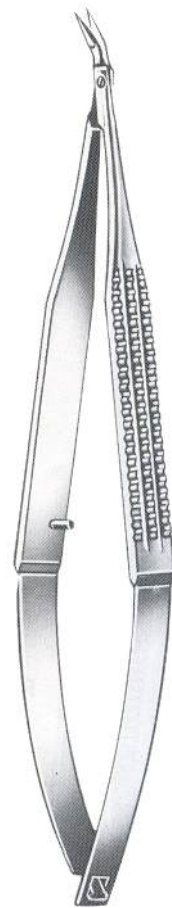

Angled up
05-1739-12
12cm/4¾"

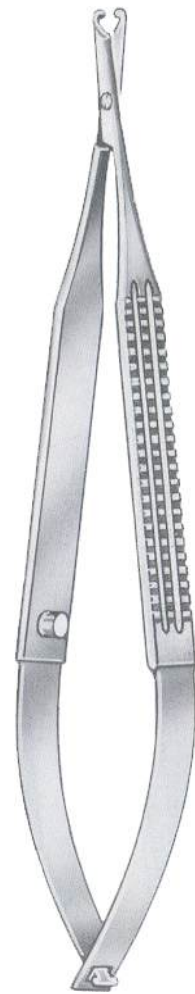

Straight
105-1740-13
13cm/5½"

SCISSORS

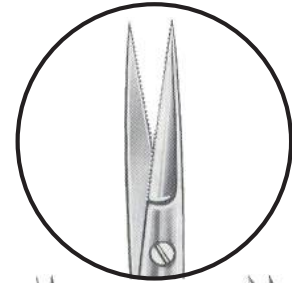

Saw Edge

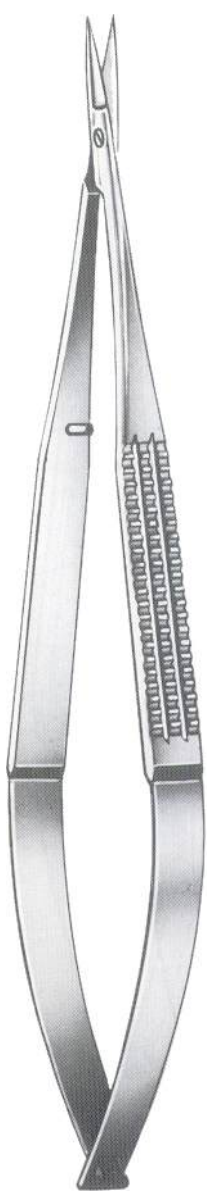

Straight
 105-1741-16
 16cm/6¼"

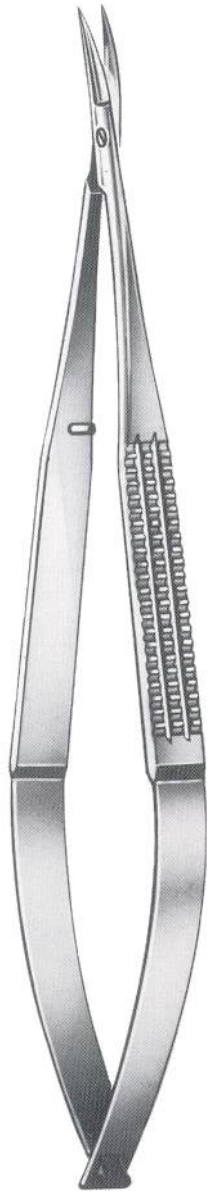

Curved
 105-1742-16
 16cm/6¼"



Straight
 105-1743-16
 16cm/6¼"

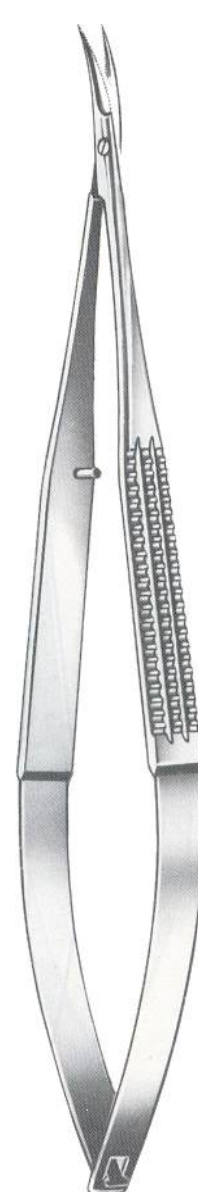

Curved
 105-1744-16
 16cm/6¼"



Millesi
Straight
 105-1745-16
 16cm/6¼"

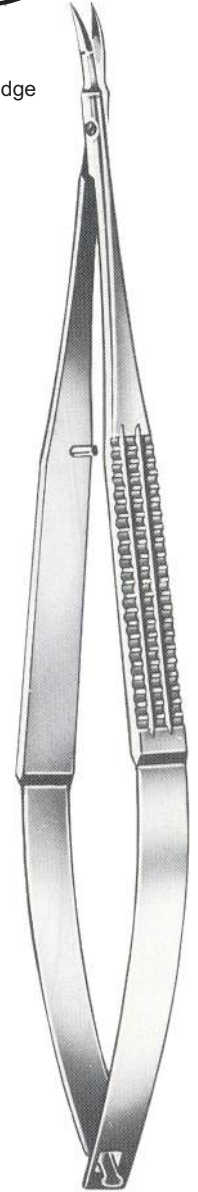

Millesi
Curved
 105-1746-16
 16cm/6¼"

SCISSORS

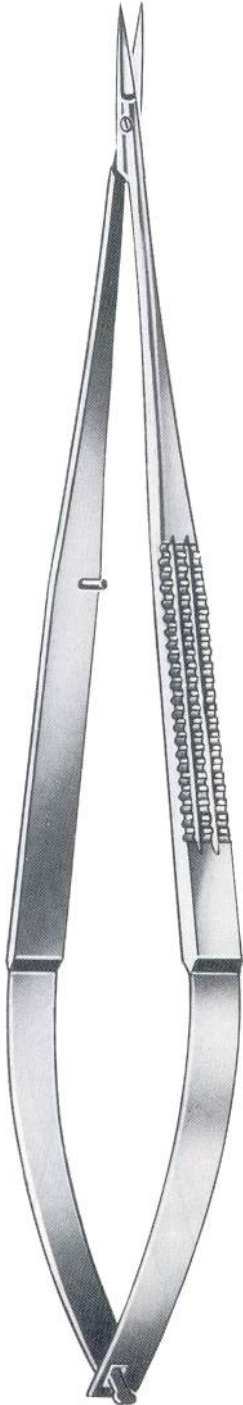

Straight
105-1747-18
18.5cm/7¼"

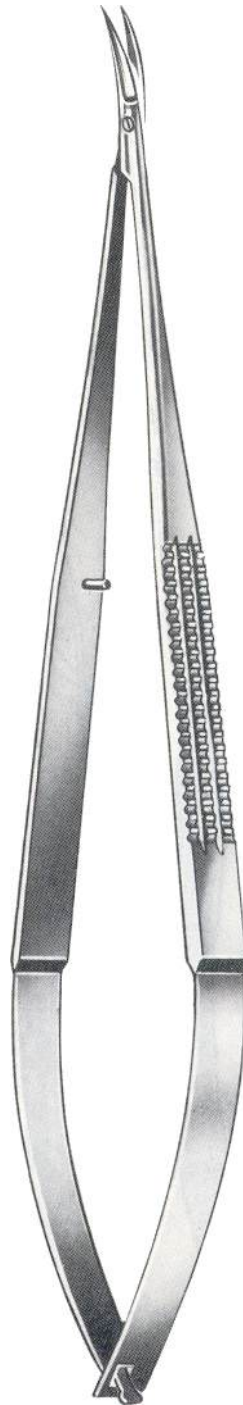

Curved
105-1748-18
18.5cm/7¼"

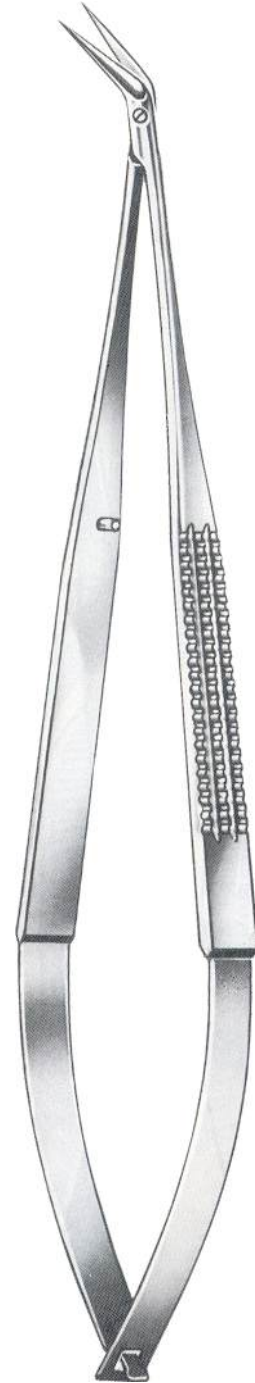

Angular
105-1749-18
18.5cm/7¼"

SCISSORS

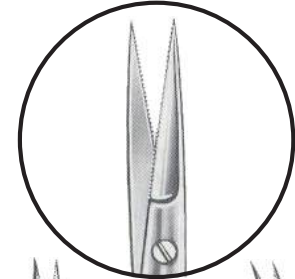

Saw Edge



Straight
 105-1750-16
 16cm/6¼"



Curved
 105-1751-16
 16cm/6¼"



Straight
 105-1752-16
 16cm/6¼"



Curved
 105-1753-16
 16cm/6¼"



Straight
 105-1754-16
 16cm/6¼"



Curved
 105-1755-16
 16cm/6¼"

SCISSORS



Straight
105-1756-18
18.5cm/7 1/4"



Curved
105-1757-18
18.5cm/7 1/4"



Angular
105-1758-18
18.5cm/7 1/4"



Straight
105-1759-23
23cm/9"

SCISSORS

Dissecting Scissors



Straight
 105-1760-14
 14.5cm/5¾"



Curved
 105-1761-14
 14.5cm/5¾"



Curved
 105-1762-14
 14.5cm/5¾"

SCISSORS



Operating Scissor

Straight	Curved
05-1763-14	05-0682-14
14.5cm/5¾"	



Mayo

Straight	Curved
05-1764-14	05-1765-14
05-1764-17	05-1765-17
05-1764-23	05-1765-23
14.5cm/5¾"	17.0cm/6¾"
17.0cm/6¾"	23.0cm/9"

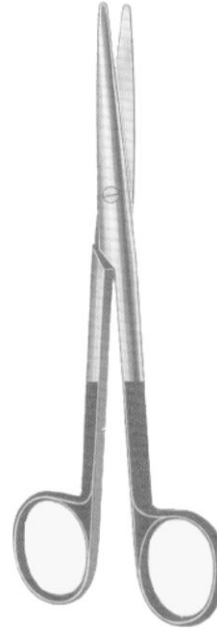

Mayo-Stille

Straight	Curved
05-1766-15	05-1767-15
05-1766-17	05-1767-17
15.0cm/6"	17.0cm/6¾"



Lexer

Straight	Curved
05-1768-16	05-1769-16
16cm/6¼"	



Baby-Metzenbaum

Straight	Curved
05-1770-11	05-1771-11
11.5cm/4½"	



Metzenbaum-Fine

Straight	Curved
05-1772-14	05-1773-14
14.5cm/5¾"	



Metzenbaum-Fine

Straight	Curved
05-1774-18	05-1775-18
05-1774-20	05-1775-20
05-1774-23	05-1775-23
18cm/7"	20cm/8"
20cm/8"	23cm/9"

SCISSORS

**Sims**

Straight		Curved
05-1776-20	20 cm/8"	05-1777-20
05-1776-23	23 cm/9"	05-1777-23

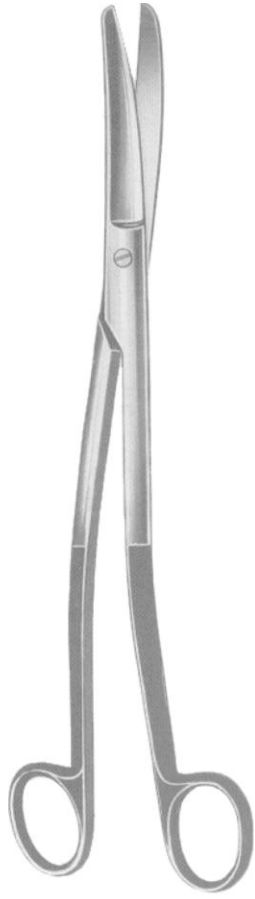
**Siebold**

05-1778-24
24 cm/9½"

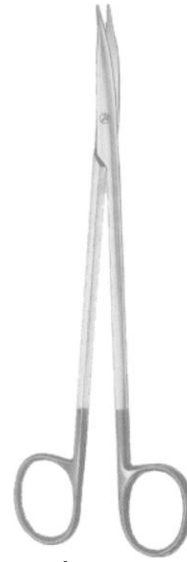
**Jameson**

05-1779-15 15 cm/6"
05-1779-18 18 cm/7"

**Reynolds**

Straight	Curved
05-1780-15	05-1781-15
	15 cm/6"



Straight	Curved
05-1782-11	05-1783-11
	11.5 cm/4½"



Straight	Curved
05-1784-11	05-1785-11
	11.5 cm/4½"



Plastic Surgery	
Straight	Curved
05-1786-12	05-1787-12
	12 cm/4¾"



Wagner	
Straight	Curved
05-1788-12	05-1789-12
	12 cm/4¾"

SCISSORS

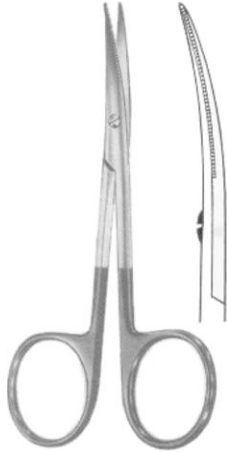

05-1790-11
11.5 cm/4½"

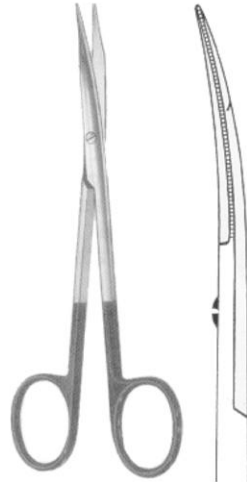

05-1791-14
14cm/5½"

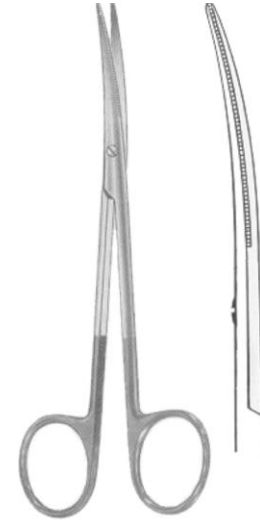

Reynolds
05-1792-13
13cm/5"

Endarterectomy Scissors



Potts-Smith
19cm/7½"



25°
05-1793-19

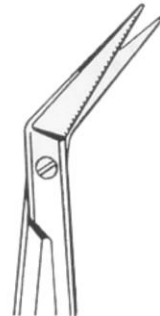

45°
05-1794-19



60°
05-1795-19

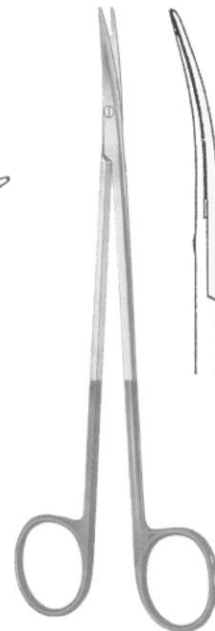

05-1796-17
17cm/6¾"

SCISSORS



Lister
05-1797-14 14.5cm/5¾"
05-1797-18 18cm/7"
05-1797-20 20cm/8"

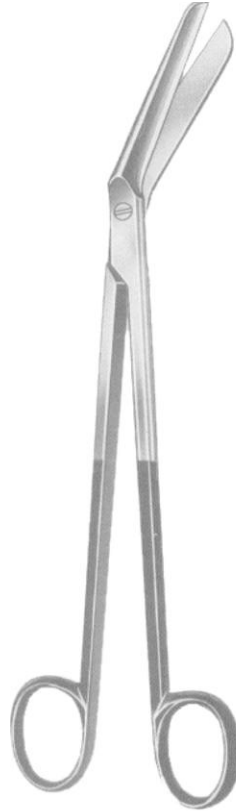

Braun-Stadler
05-1798-14 14.5cm/5¾"
05-1798-22 22cm/8¾"

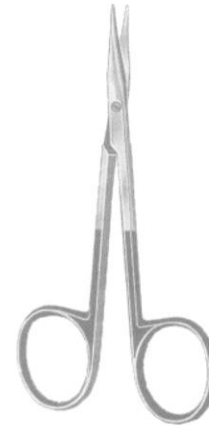

Stevens
Straight Curved
05-1799-11 11.5cm/4½" 05-1800-11



Heymann
05-1801-18
18cm/7"



Fomon
05-1802-13
13cm/5"



Fomon
05-1803-13
13cm/5"



Cottle
05-1804-16
16cm/6¼"

SCISSORS

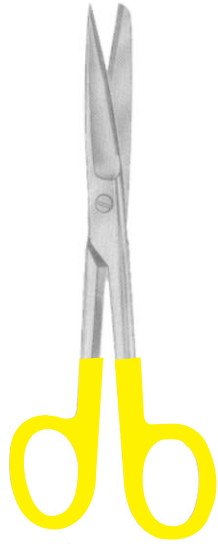

Standard
14.5cm/5¾"

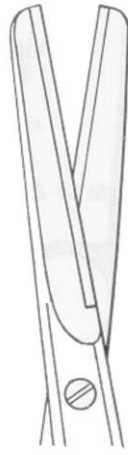

Fig. 1
05-1805-14



Fig. 2
05-1806-14



Fig. 3
05-1807-14

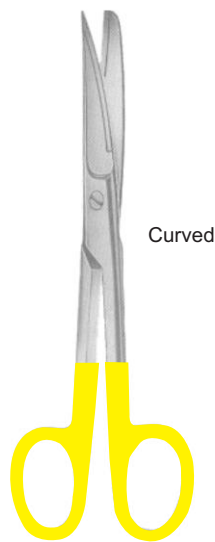

Curved

Standard
14.5cm/5¾"



Fig. 1
05-1808-14



Fig. 2
05-1809-14



Fig. 3
05-1810-14

SCISSORS



Lexer
Straight
05-1811-16
16 cm/6¼"



Lexer
Curved
05-1812-16
16 cm/6¼"



Mayo
Straight
05-1813-14 14.5 cm/5¾"
05-1813-18 18.0 cm/7"
05-1813-23 23.0 cm/9"



Mayo
Curved
05-1814-14 14.5 cm/5¾"
05-1814-18 18.0 cm/7"
05-1814-23 23.0 cm/9"



Lexer-Fine
Straight
005-1815-16
16 cm/6¼"



Lexer-Fine
Curved
05-1816-16
16 cm/6¼"

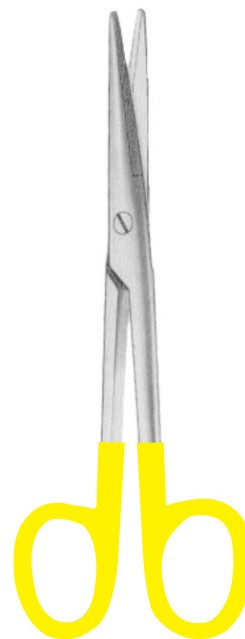

Mayo-Stille
Straight
05-1817-15 15 cm/6"
05-1817-17 17 cm/6¾"



Mayo-Stille
Curved
05-1818-15 15 cm/6"
05-1818-17 17 cm/6¾"

SCISSORS

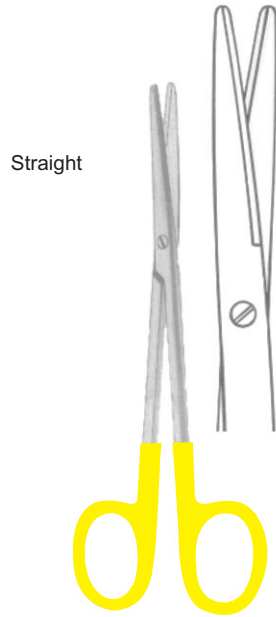

Metzenbaum
05-1819-14
14.5 cm/5¾"

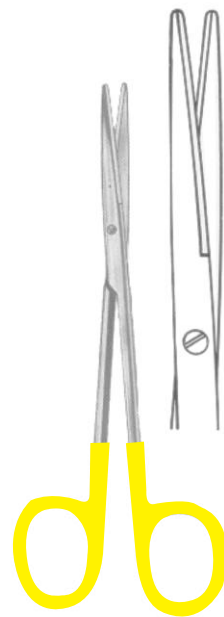

Metzenbaum-Fine
05-1820-14
14.5 cm/5¾"

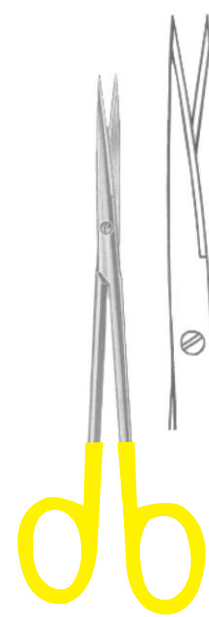

Metzenbaum-Fine
05-1821-14
14.5 cm/5¾"

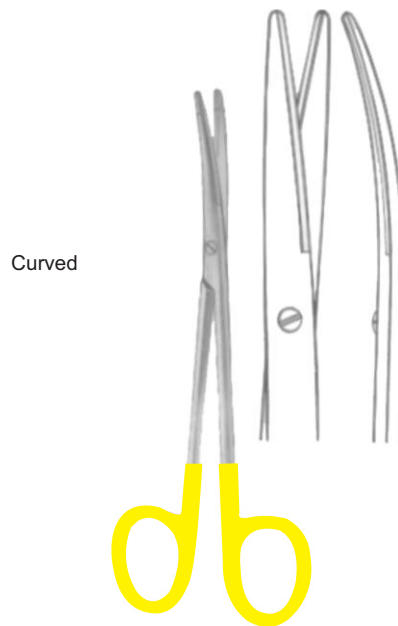

Metzenbaum
05-1822-14
14.5 cm/5¾"



Metzenbaum-Fine
05-1823-14
14.5 cm/5¾"

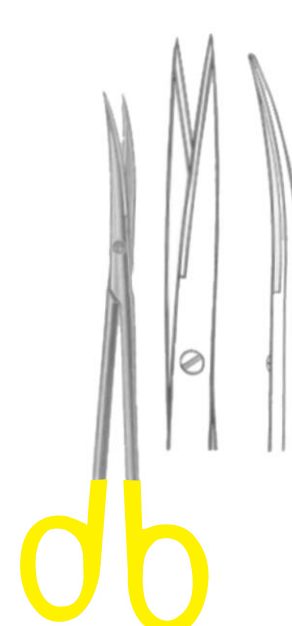

Metzenbaum-Fine
05-1824-14
14.5 cm/5¾"

SCISSORS

Straight

**Metzenbaum**

18 cm/7"	05-1825-18
20 cm/8"	05-1825-20
23 cm/9"	05-1825-23
25 cm/10"	05-1825-25
28 cm/11"	05-1825-28
30 cm/12"	05-1825-30

**Metzenbaum-Fine**

05-1826-18
05-1826-20
05-1826-23
05-1826-25
05-1826-28
05-1826-30

**Metzenbaum-Fine**

05-1827-18
05-1827-20
05-1827-23
05-1827-25
05-1827-28
05-1827-30

Curved

**Metzenbaum**

18 cm/7"	05-1828-18
20 cm/8"	05-1828-20
23 cm/9"	05-1828-23
25 cm/10"	05-1828-25
28 cm/11"	05-1828-28
30 cm/12"	05-1828-30

**Metzenbaum-Fine**

05-1829-18
05-1829-20
05-1829-23
05-1829-25
05-1829-28
05-1829-30

**Metzenbaum-Fine**

05-1830-18
05-1830-20
05-1830-23
05-1830-25
05-1830-28
05-1830-30

SCISSORS

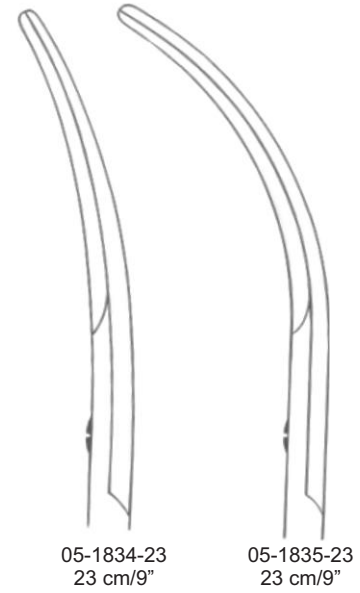
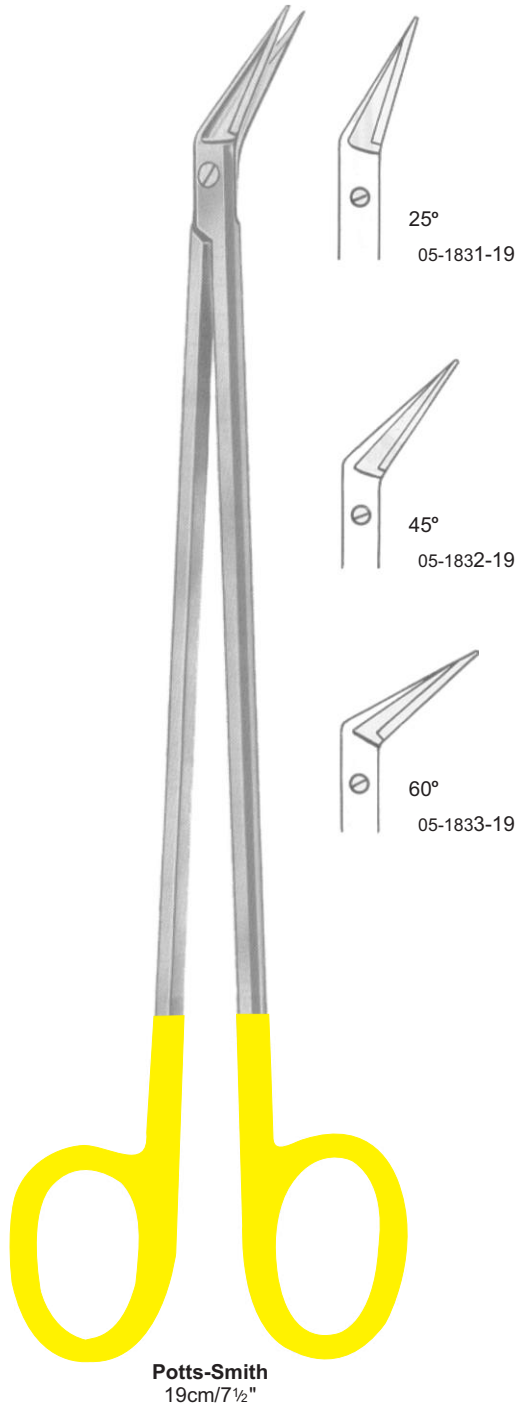

Sims
05-1836-20 20 cm/8"
05-1836-23 23 cm/7"

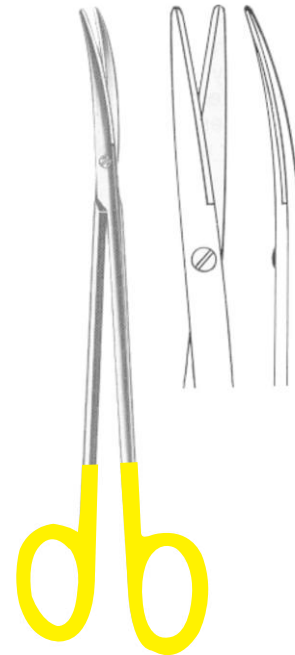

Tonnis-Adson
05-1837-17
17.5cm/7"

SCISSORS



Lister
05-1838-18
18 cm/7"

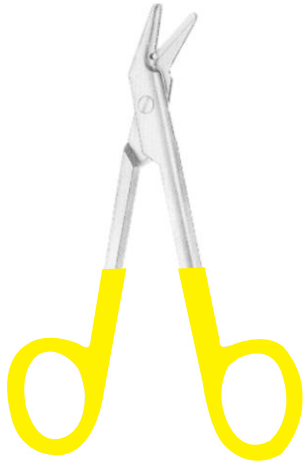

Universal
05-1839-12
12 cm/4¾"

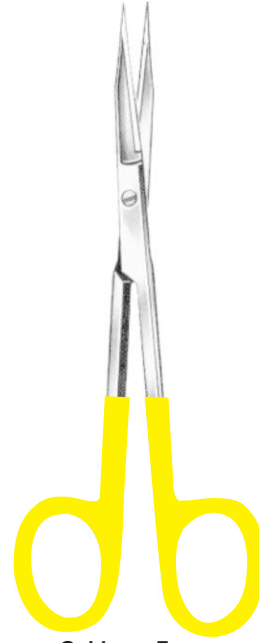

Goldman-Fox
Straight
05-1840-13
13 cm/5"



Goldman-Fox
Curved
05-1841-13
13 cm/5"

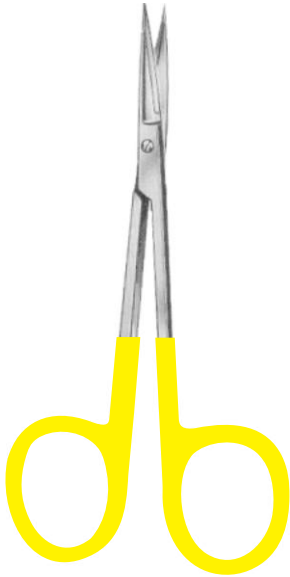

Straight
05-1842-11



Curved
05-1843-11
11.5cm/4½"

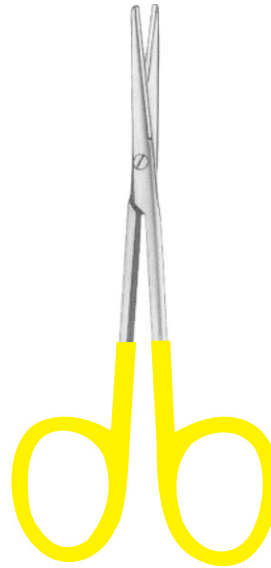

Straight
05-1844-11

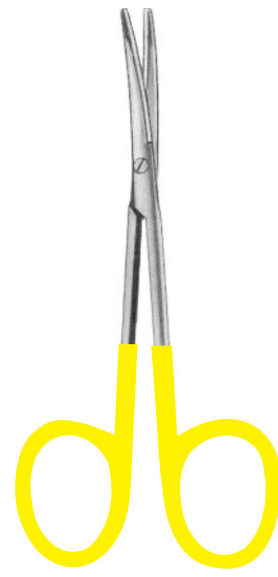

Curved
05-1845-11
11.5cm/4½"

EN Forceps

DE Pinzetten

ES Pinzas

Page 95 to 111



FORCEPS

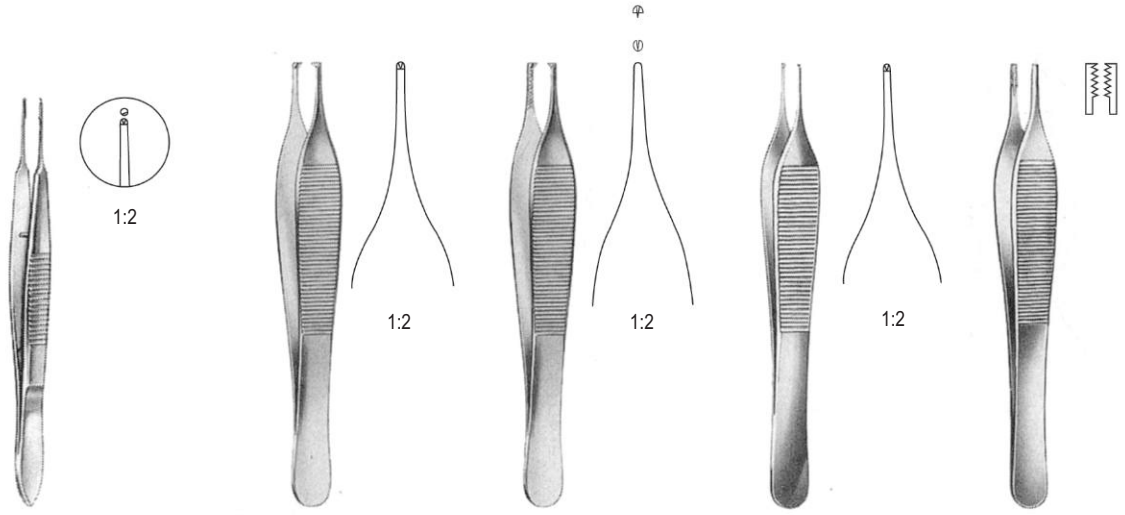

06-1980-11
11.0cm

Adson
06-1981-12 12.0cm
06-1981-15 15.0cm

Adson
06-1982-12 12.0cm

Micro-Adson
06-1983-12 12.0cm

Adson-Brown
06-1984-12 12.0cm

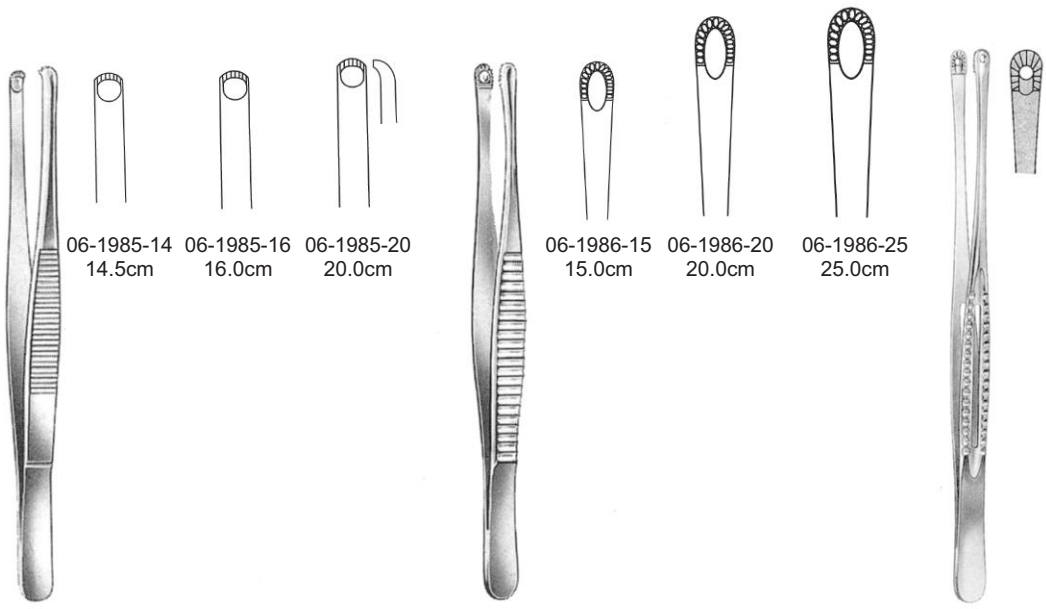

Durante

Russ Modell

Mayo Russ
06-1987-23 23.0cm

FORCEPS

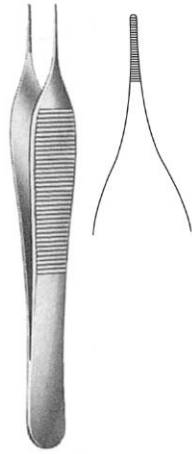

Micro Adson
06-1988-12 12.0cm



06-1989-12 12.0cm 06-1990-12 12.0cm
06-1989-16 16.0cm 06-1990-16 16.0cm

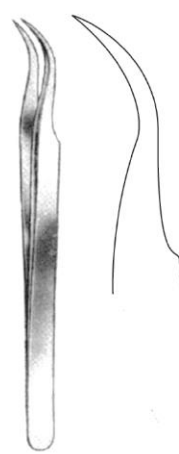

10 cm
11.5cm



06-1991-01
06-1991A-01



06-1991-02
06-1991A-02



06-1991-03
06-1991A-03



1:2
06-1992-01
06-1992A-01



1:2
06-1992-02
06-1992A-02



1:2
06-1992-03
06-1992A-03



Yasargil
22.0cm



06-1993-03
3mm Ø



06-1993-05
5mm Ø



Yasargil
22.0cm



06-1994-03
3mm Ø



06-1994-05
5mm Ø



Heifetz
22.0cm



06-1995-03
3mm Ø



06-1995-05
5mm Ø

FORCEPS

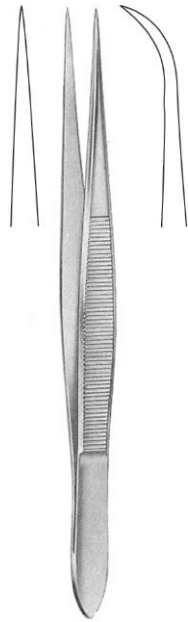

06-1996-09 09.0cm
06-1996-10 10.5cm
06-1996-11 11.5cm
06-1996-12 12.0cm

06-1997-09
06-1997-10
06-1997-11
06-1997-12

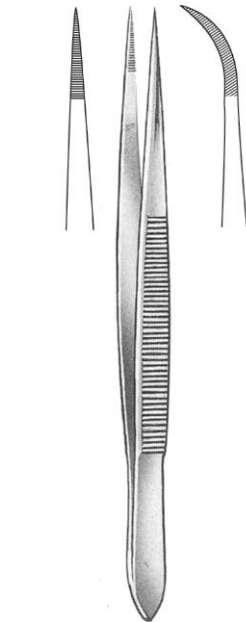

06-1998-09 09.0cm
06-1998-10 10.5cm
06-1998-11 11.5cm
06-1998-12 12.0cm

06-1999-09
06-1999-10
06-1999-11
06-1999-12



06-2000-18

Gomel
18.0cm



1:2



06-2001-18

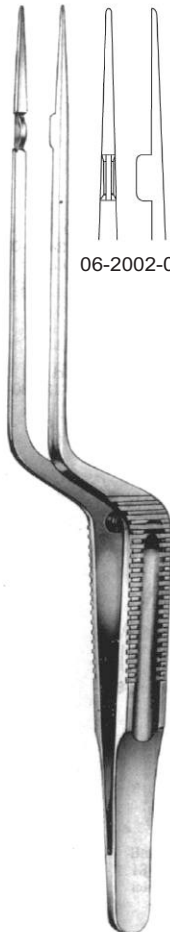

06-2002-01

06-2002-02

22.5cm



06-2003-01

06-2003-02

06-2003-03

18.5cm

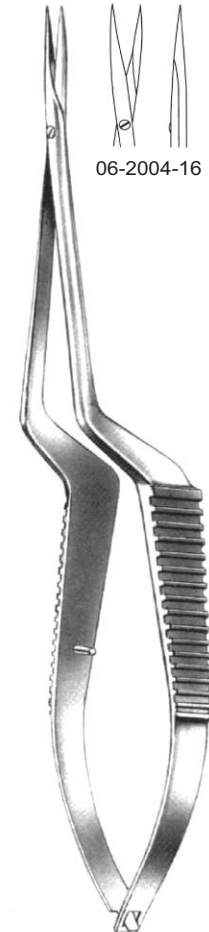

06-2004-16

15.5cm

FORCEPS

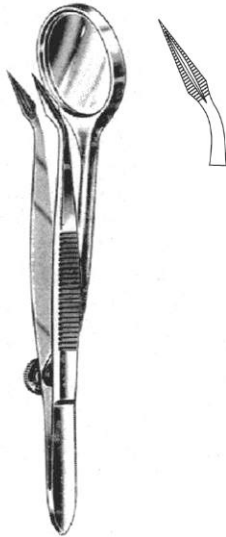

06-2005-12
12.0cm



Feilchenfeld



06-2006-07
7.5cm



06-2006-09
9.0cm



06-2006-20
11.5cm



06-2007-12
12.5cm



06-2008-10



Hunter
10.5cm



06-2009-10



06-2010-10



Walter-Carmalt
10.5cm



06-2011-10

FORCEPS



Duval
14.5cm



06-2012-07
7mm



06-2012-10
10mm



Collin-Duval
20.0cm



06-2013-14
14mm



06-2013-18
18mm

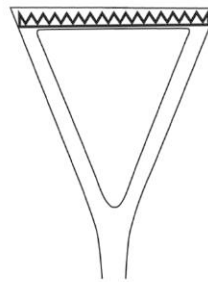

06-2013-27
27mm



Hepp/Scheidel
06-2014-18 18.0cm



Singley-Tuttle
06-2015-23 23.0cm



Nelson
06-2016-23 23.0cm



06-2017-21
21.0cm

FORCEPS

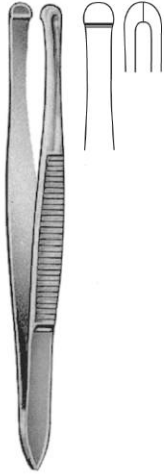

Beer
06-2018-09 9.0cm



Littauer
06-2019-08 8.5cm



06-2020-09 9.0cm

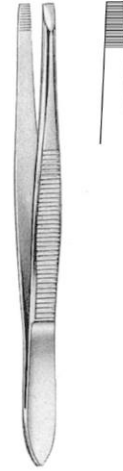

Douglas
06-2021-09 9.0cm



Douglas
06-2022-09 9.0cm



Barraquer
06-2023-10 10.5cm



Gradle
06-2024-09 9.5cm



Henry
06-2025-12 12.0cm

FORCEPS



Peet
06-2026-11 11.5cm

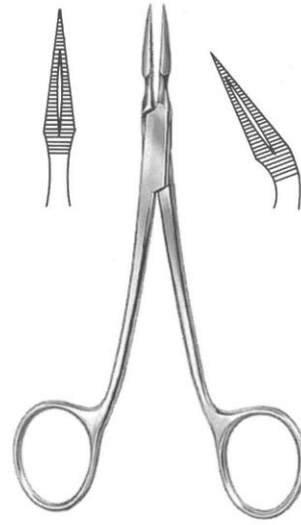

Arther
06-2027-14 14.0cm 12.0401.14

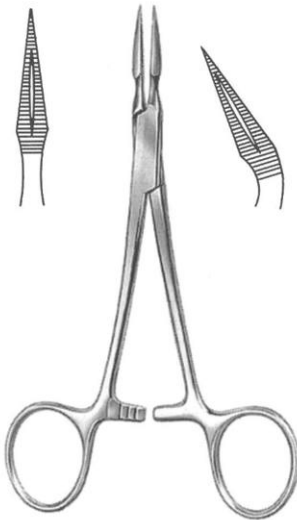

Stieglitz
06-2028-13 13.5cm 06-2029-13

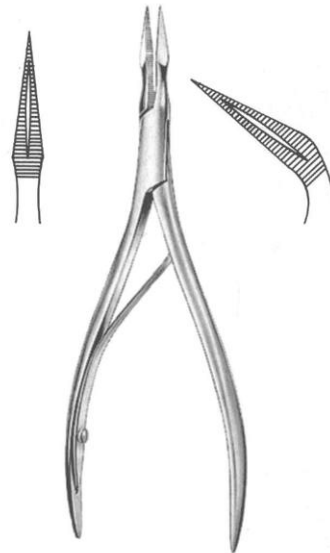

Ralk
06-2030-15 15.0cm 06-2031-15

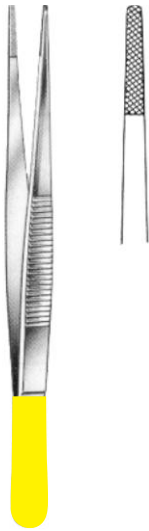
FORCEPS

Standard

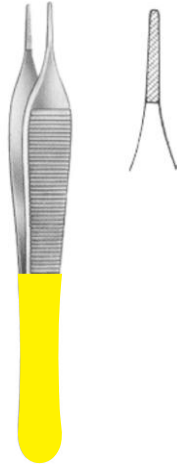
06-2032-14 14.5cm/5 ¾"
 06-2032-16 16cm/6 ¼"
 06-2032-18 18cm/7"
 06-2032-20 20cm/8"
 06-2032-25 25cm/10"

Adson

06-2033-12 12cm/4 ¾"
 06-2033-15 15.5cm/6"

McIndoe

06-2034-15
 15cm/6"

Semken

06-2035-12 12cm/4 ¾"
 06-2035-15 15cm/6"



06-2036-18
 18cm/7"



Cushing
 06-2037-18
 18cm/7"



Cushing-Taylor
 06-2038-18
 18cm/7"



Grunwald
 06-2039-18
 18cm/7"

FORCEPS



Wangenstein
 06-2040-15 15cm/6"
 06-2040-23 13cm/9"
 06-2040-25 25cm/10"



06-2041-15 15cm/6"
 06-2041-18 18cm/7"
 06-2041-20 20cm/8"
 06-2041-23 23cm/9"
 06-2041-25 25cm/10"



Oehler
 1:2
 06-2042-14 14.5cm/5 1/2"
 06-2042-16 16cm/6 1/4"
 06-2042-18 18cm/7"
 06-2042-20 20cm/8"
 06-2042-25 25cm/10"
 06-2042-30 30cm/12"

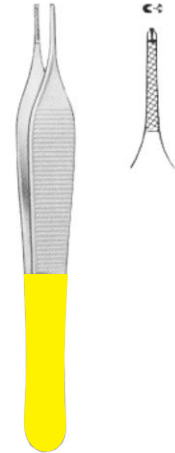

Micro-Adson
 06-2043-12 12cm/4 3/4"
 06-2043-15 15.5cm/6"

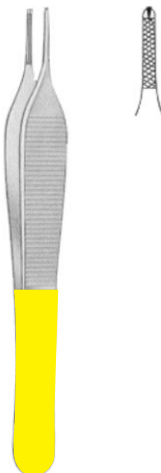

Standard-Adson
 06-2044-12 12cm/4 3/4"
 06-2044-15 15.5cm/6"



Adson-Brown
 06-2045-12
 12cm/4 3/4"



Gillies
 06-2046-15
 15 cm/6"

- EN** Artery Forceps
- DE** Arterienklemmen
- ES** Pinzas hemostáticas

Page 112 to 140



ARTERY FORCEPS



Terrier
07-2101-10 10 cm/4"



Pennington
07-2102-15 15 cm/6"
07-2102-20 20 cm/8"



Peau
07-2103-12 12.5 cm/5"

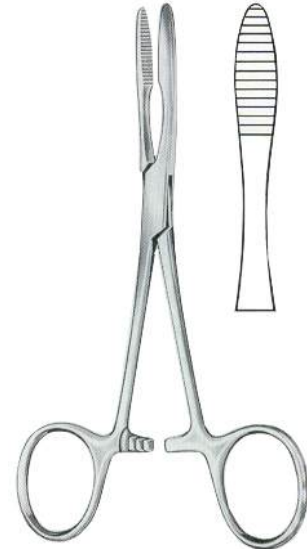

Peau
07-2104-14 14 cm/5 3/4"
07-2104-16 16 cm/6 1/4"

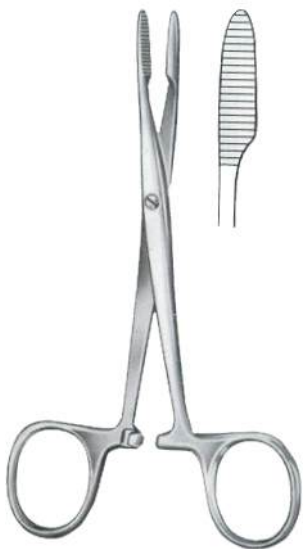

Peau
07-2105-14 14 cm/5 1/2"

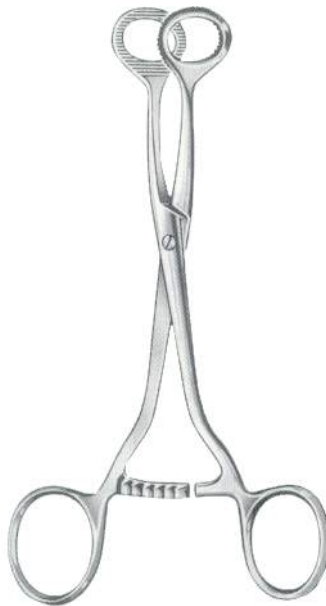

Collin
07-2106-15 15.5 cm/6"



Collin
07-2107-14 14 cm/5 1/2"



Collin
07-2108-16 16.5 cm/6 1/2"

ARTERY FORCEPS



Hartmann
 10 cm/4"

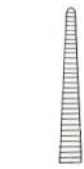

07-2109-10



07-2110-10



07-2111-10



07-2112-10



Halstead-Mosquito
 12 cm/4¾"
 14 cm/5½"



07-2113-12
 07-2113-14



07-2114-12
 07-2114-14



07-2115-12
 07-2111-14



07-2116-12
 07-2116-14



Micro-Mosquito
 10 cm/4"
 12 cm/4¾"



07-2117-10
 07-2117-12



07-2118-10
 07-2118-12



07-2119-10
 07-2119-12



07-2120-10
 07-2120-12



Jacobson-Halstead
 13 cm/5"

Very fine



07-2121-13



07-2122-13

ARTERY FORCEPS

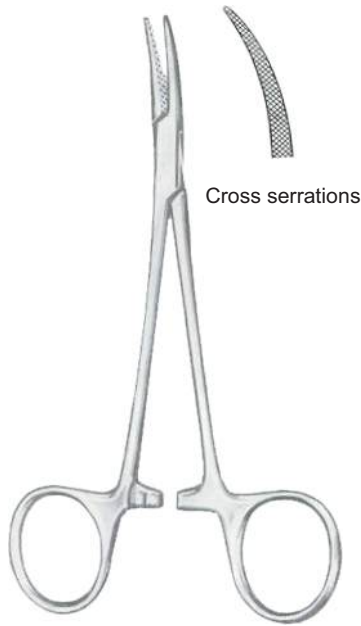

Cross serrations

07-2123-12
12 cm/4¾"



Halstead-Mosquito
18 cm/7"
21 cm/8¼"



07-2124-18
07-2124-21



07-2125-18
07-2125-21



07-2126-18
07-2126-21



07-2127-18
07-2127-21



Kelly
14 cm/5½"
Kelly-Rankin
16 cm/6¼"



07-2128-14



14 cm/5½" 07-2129-14



07-2130-16



16 cm/6¼" 07-2131-16

ARTERY FORCEPS



Crile
14 cm/5½"

Crile-Rankin
16 cm/6¼"

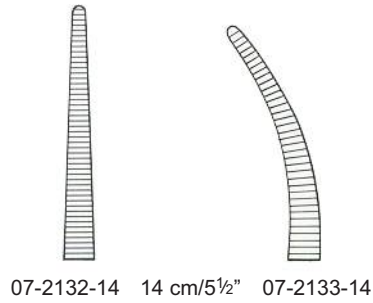

07-2132-14 14 cm/5½" 07-2133-14

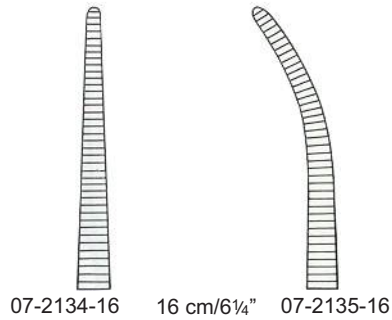

07-2134-16 16 cm/6¼" 07-2135-16



Baby-Crile
14 cm/5½"

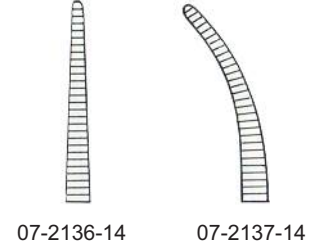

07-2136-14 07-2137-14



Crile
14 cm/5½"

Crile-Rankin
16 cm/6¼"

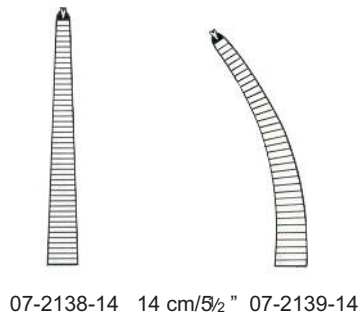

07-2138-14 14 cm/5½" 07-2139-14

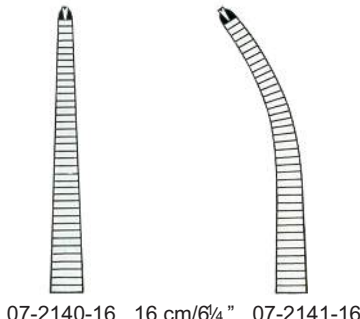

07-2140-16 16 cm/6¼" 07-2141-16



Baby-Crile
14 cm/5½"

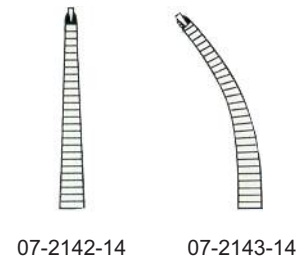

07-2142-14 07-2143-14

ARTERY FORCEPS



Coller-Crile

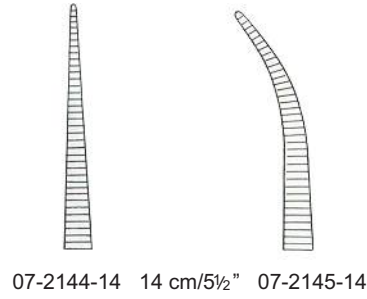

07-2144-14 14 cm/5 1/2" 07-2145-14

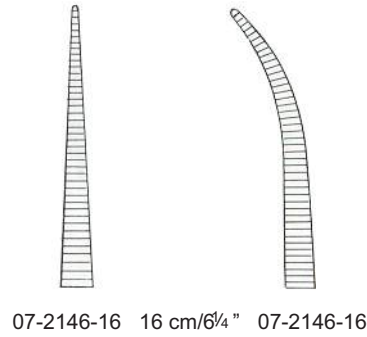

07-2146-16 16 cm/6 1/4" 07-2146-16



Coller-Crile
07-2147-16
16 cm/6 1/4"



Leriche
15 cm/6"

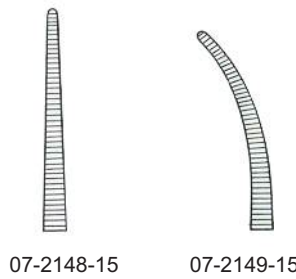

07-2148-15 07-2149-15

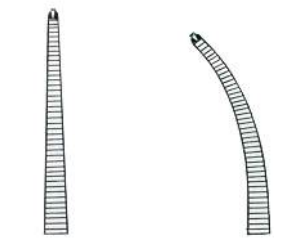

07-2150-15 07-2151-15



Providence
14 cm/5 1/2"



07-2152-14



07-2153-14

ARTERY FORCEPS

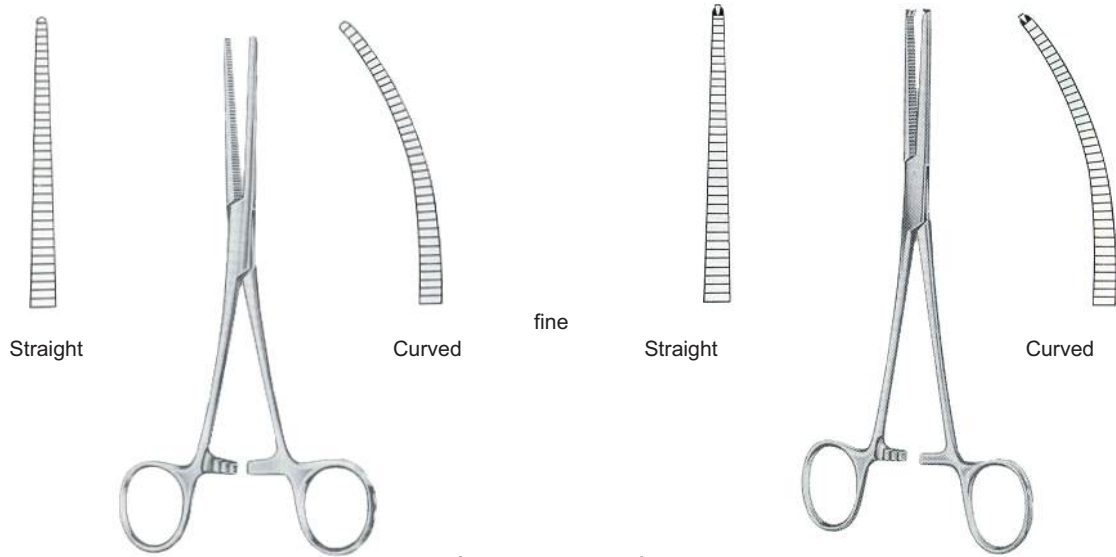

Rochester-Pean		cm	in	Ochsner-Kocher	
07-2154-13	07-2155-13	13.0	5"	07-2156-13	07-2157-13
07-2154-14	07-2155-14	14.0	5½"	07-2156-14	07-2157-14
07-2154-16	07-2155-16	16.0	6¼"	07-2156-16	07-2157-16

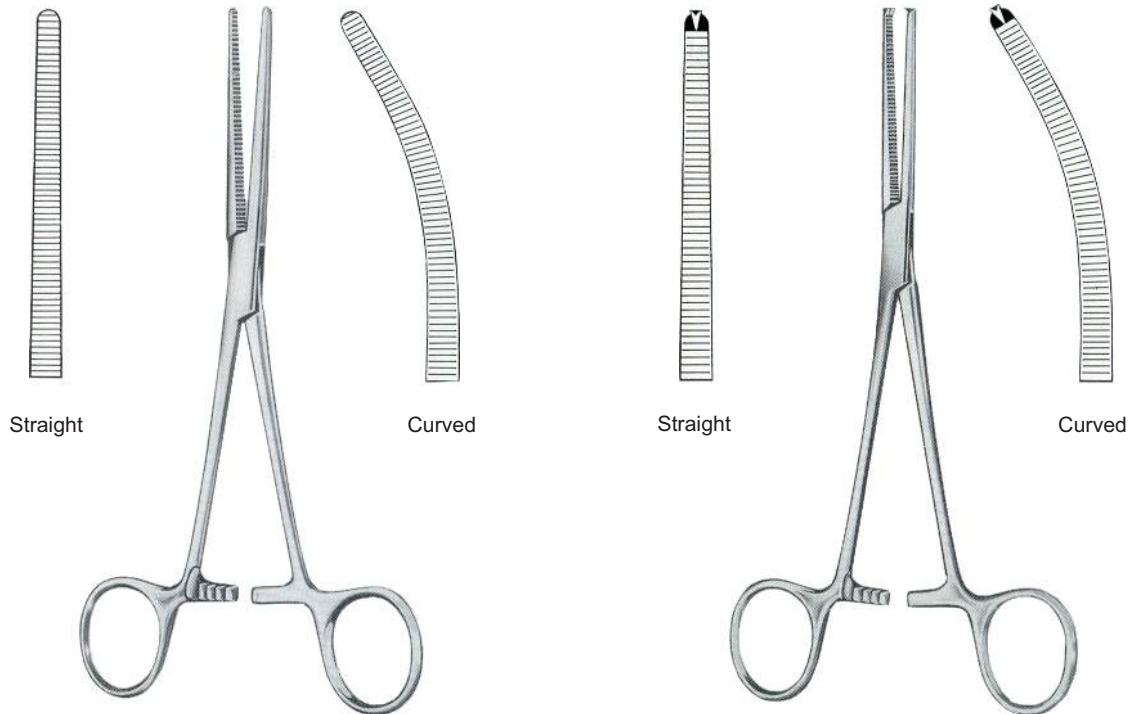

Rochester-Pean		cm	in	Ochsner-Kocher	
07-2158-13	07-2159-13	13.0	5"	07-2160-13	07-2161-13
07-2158-14	07-2159-14	14.0	5½"	07-2160-14	07-2161-14
07-2158-16	07-2159-16	16.0	6¼"	07-2160-16	07-2161-16
07-2158-18	07-2159-18	18.0	7"	07-2160-18	07-2161-18
07-2158-20	07-2159-20	20.0	8"	07-2160-20	07-2161-20
07-2158-22	07-2159-22	22.0	8¾"	07-2160-22	07-2161-22
07-2158-24	07-2159-24	24.0	9½"	07-2160-24	07-2161-24
07-2158-26	07-2159-26	26.0	10¼"	07-2160-26	07-2161-26
07-2158-30	07-2159-30	30.0	12"	07-2160-30	07-2161-30

ARTERY FORCEPS

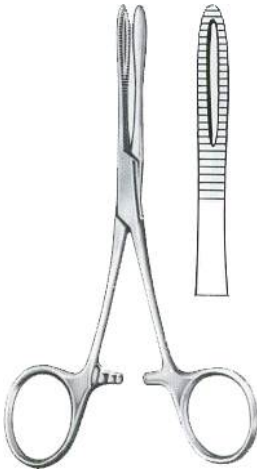
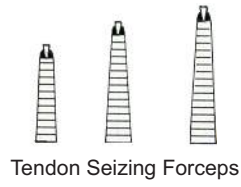

Kronlein
07-2162-13
13cm/5"



Brand
07-2163-15 15cm/6"
07-2163-19 19cm/7 1/2"
07-2163-24 24cm/9 1/2"



Brand
07-2164-15 15cm/6"
07-2164-19 19cm/7 1/2"
07-2164-24 24cm/9 1/2"

Lateral Curved

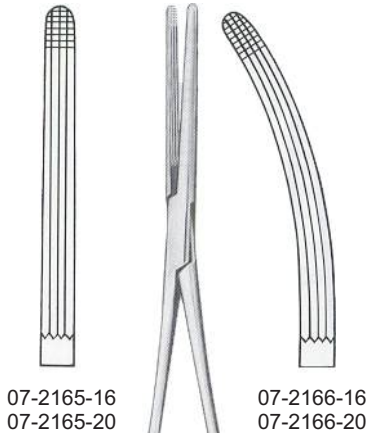

Rochester-Carmalt
16cm/6 1/4"
20cm/8"

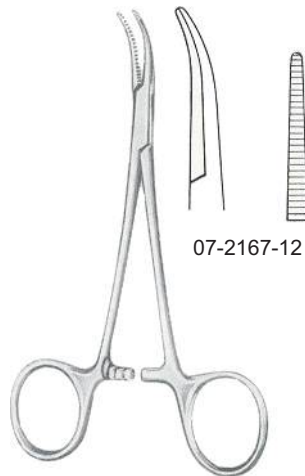

Mosquito-Dandy
12cm/4 3/4"



Dandy
14cm/5 1/2"

ARTERY FORCEPS



Lovelace
 07-2171-15
 15.5cm/6"



Dixon-Lovelace
 07-2172-16
 16cm/6¼"



Dixon-Lovelace
 07-2173-16
 16cm/6¼"

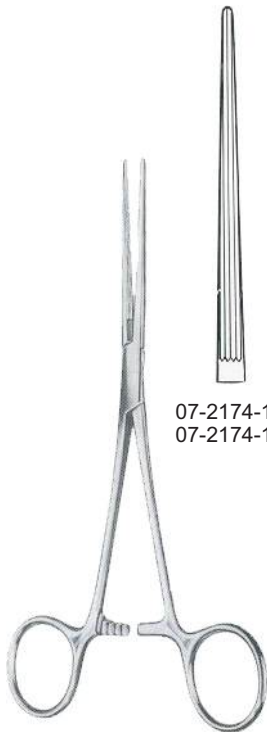

Bainbridge
 15cm/6"
 18cm/7"

07-2174-15
 07-2174-18



07-2175-15
 07-2175-18



Fuchsig
 07-2176-19
 19cm/7½"

ARTERY FORCEPS



Adson
18.5cm/7¼"

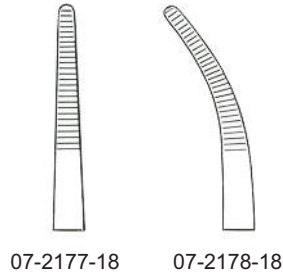

07-2177-18 07-2178-18

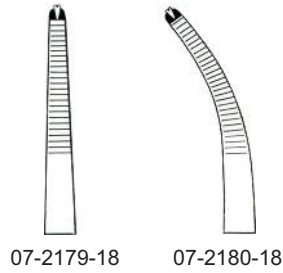

07-2179-18 07-2180-18



Nissen
07-2181-18 18.5cm/7 ¼"
07-2181-22 22.0cm/8 ¾"



Baby-Adson



07-2182-14
14cm/5½"

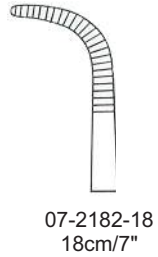

07-2182-18
18cm/7"

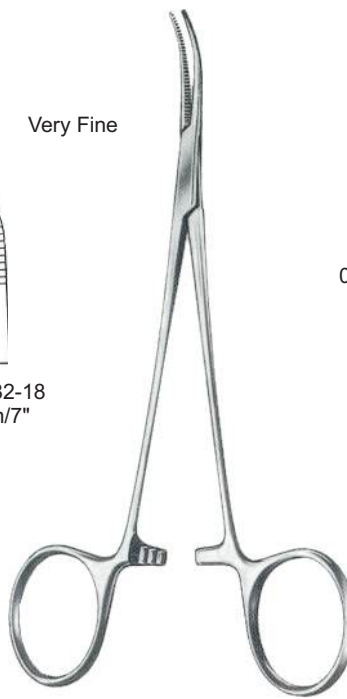

Jacobson-Adson
18cm/7"

Very Fine

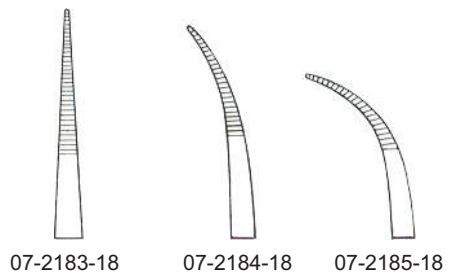

07-2183-18 07-2184-18 07-2185-18

ARTERY FORCEPS

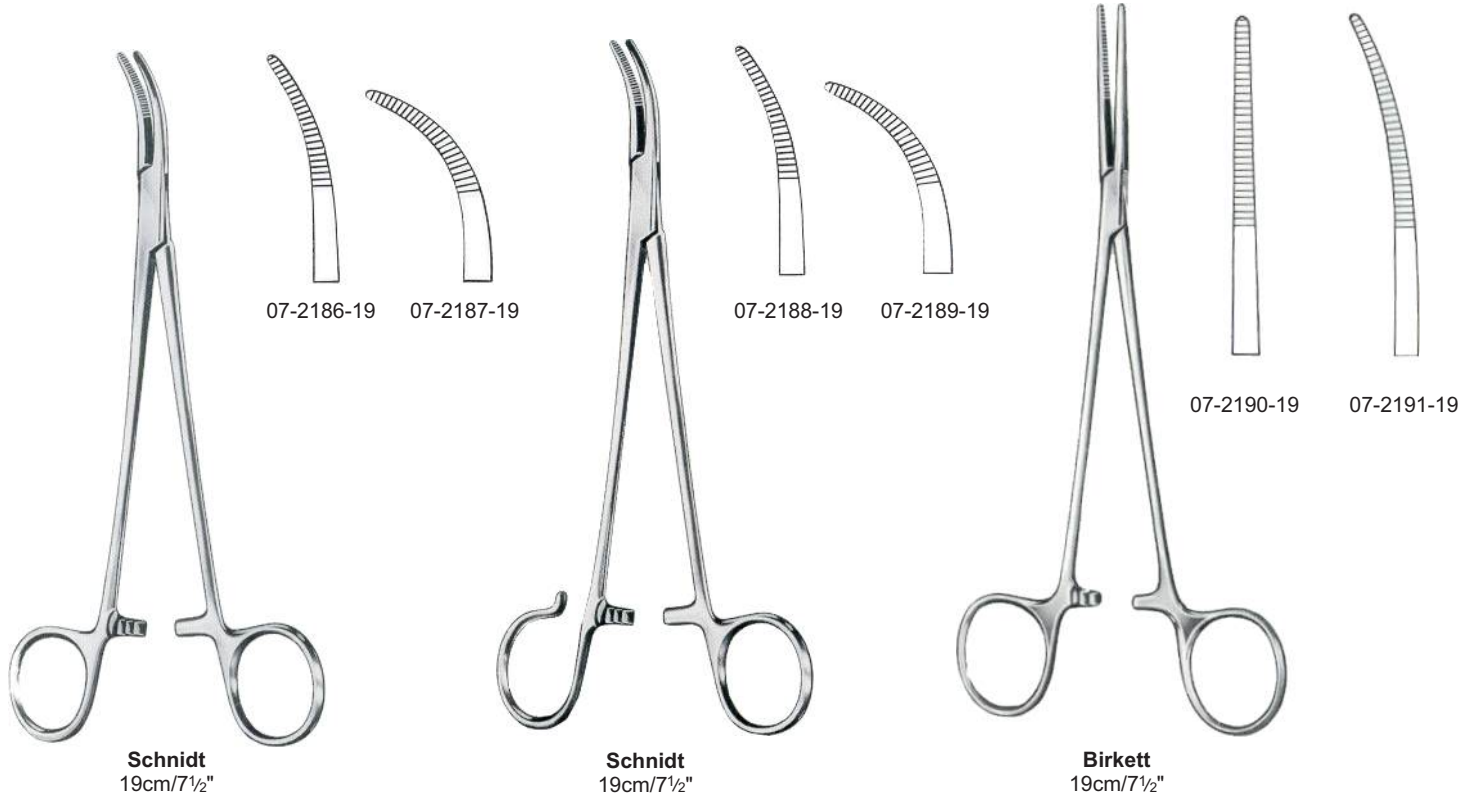

Bengolea

20cm/8"	07-2192-20	07-2193-20	07-2194-20	07-2195-20
22cm/8¾"	07-2192-22	07-2193-22	07-2194-22	07-2195-22
24cm/9½"	07-2192-24	07-2193-24	07-2194-24	07-2195-24
26cm/10¼"	07-2192-26	07-2193-26	07-2194-26	07-2195-26

ARTERY FORCEPS



07-2196-27



07-2197-27

Bridge
27cm/10½"



07-2198-22



07-2199-22

Roberts
22cm/8¾"



Kelly

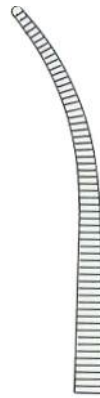

19cm/7½"

07-2200-19



22cm/8¾"

07-2200-22



24cm/9½"

07-2201-19

07-2201-22

07-2202-19

07-2202-22

24cm/9½"

07-2200-24

07-2201-24

07-2202-24

ARTERY FORCEPS

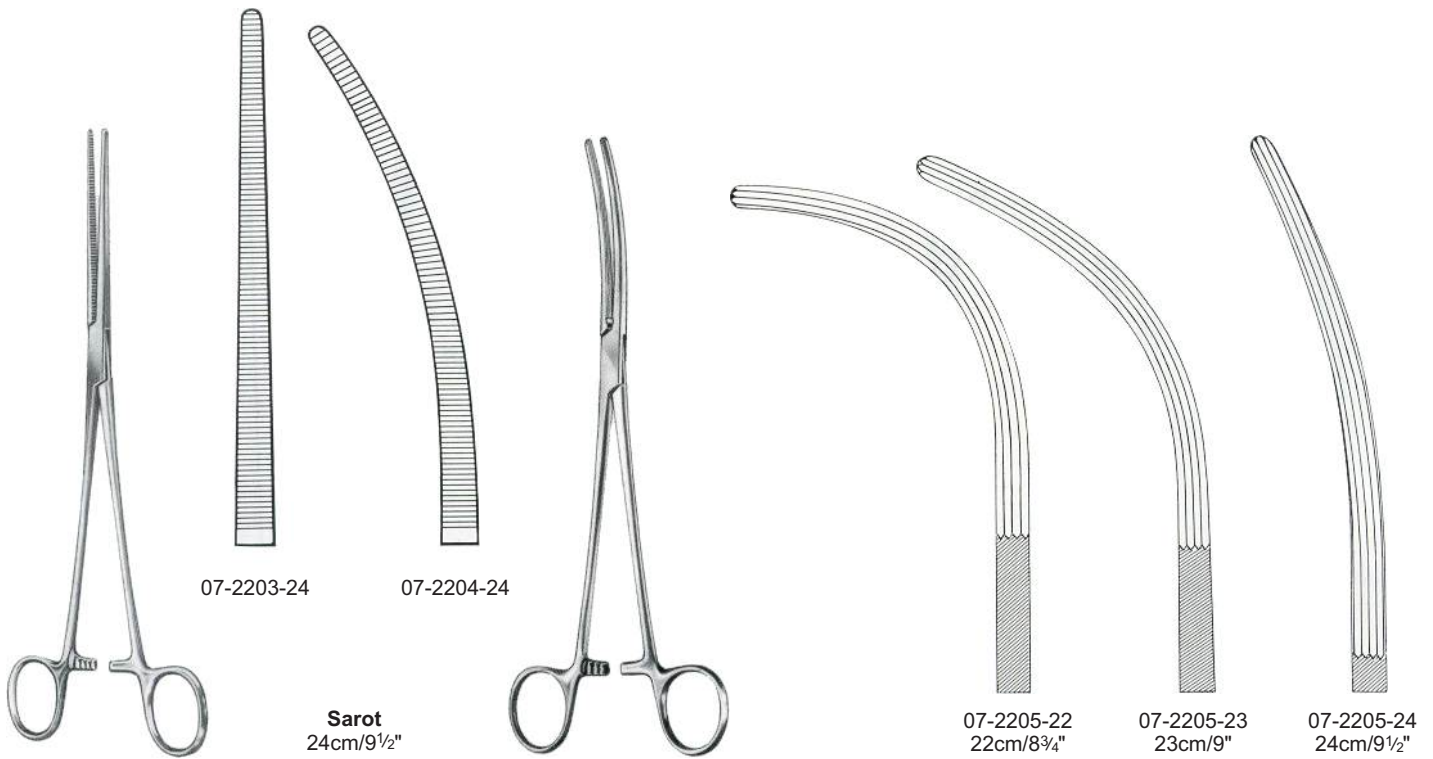

Crafoord-Sellors

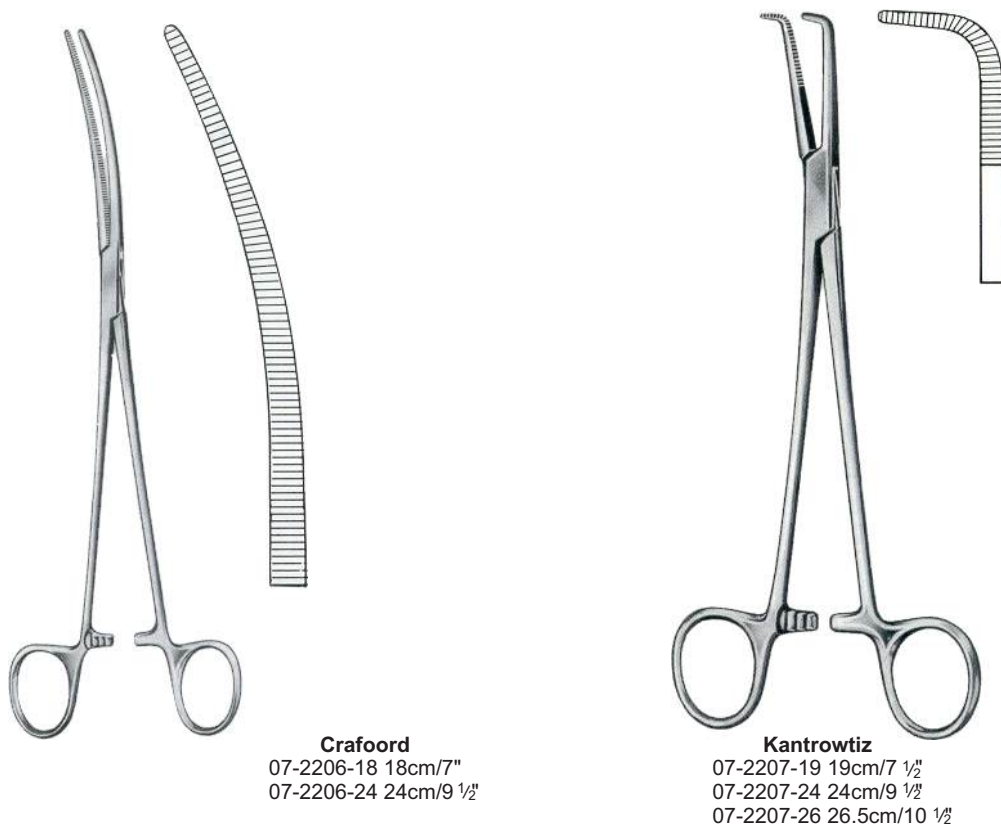

ARTERY FORCEPS



Rumel
23cm/9"

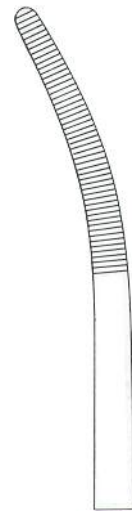

07-2208-23



07-2209-23



07-2210-23

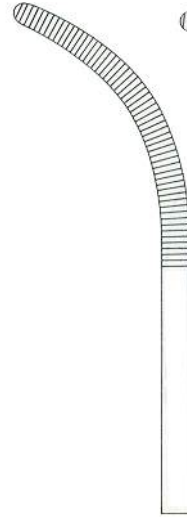

07-2211-23

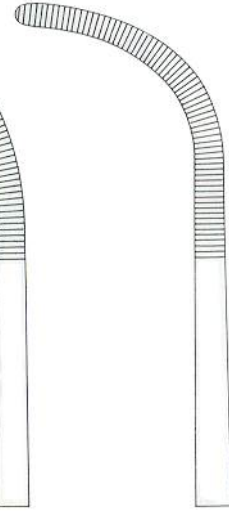

07-2212-23



Johns Hopkins
07-2213-20
20cm/8"



Zenker
29.5cm/11½"



07-2214-29



07-2215-29

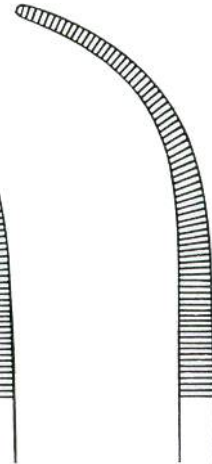

07-2216-29

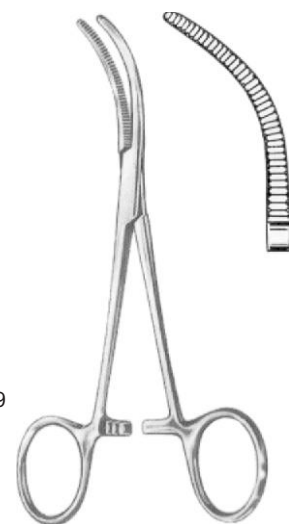

Baby-Overholt
07-2217-13
13.5cm/5¼"

ARTERY FORCEPS



Overholt-Slim



07-2218-18
18.5cm/7¼"

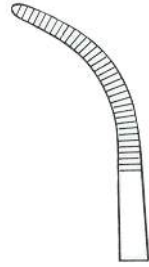

07-2219-20
20.5cm/8"

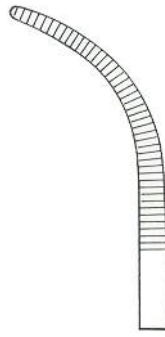

07-2220-21
21cm/8¼"

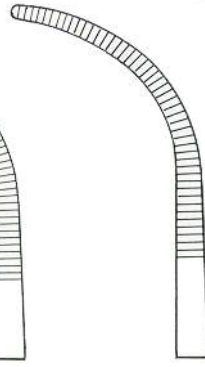

07-2221-21
21.5cm/8½"

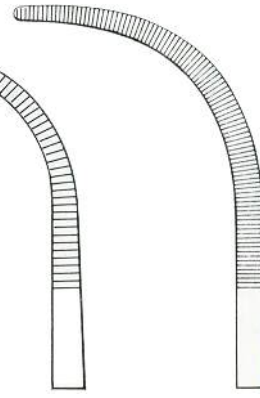

07-2222-24
24cm/9½"



Overholt-Slim



07-2223-18
18.5cm/7¼"



07-2224-20
20.5cm/8"

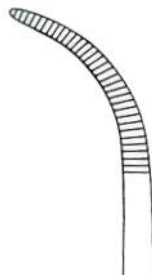

07-2225-21
21cm/8¼"

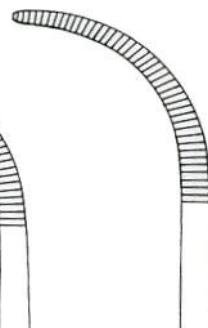

07-2226-21
21.5cm/8¼"

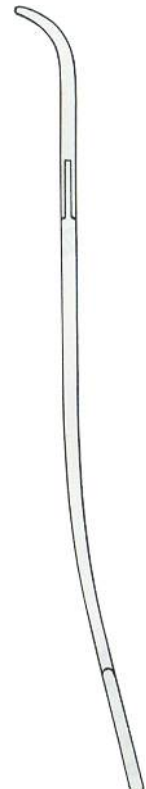

ARTERY FORCEPS



Overholt-Geissendorfer
21cm/8¼"
27cm/10½"

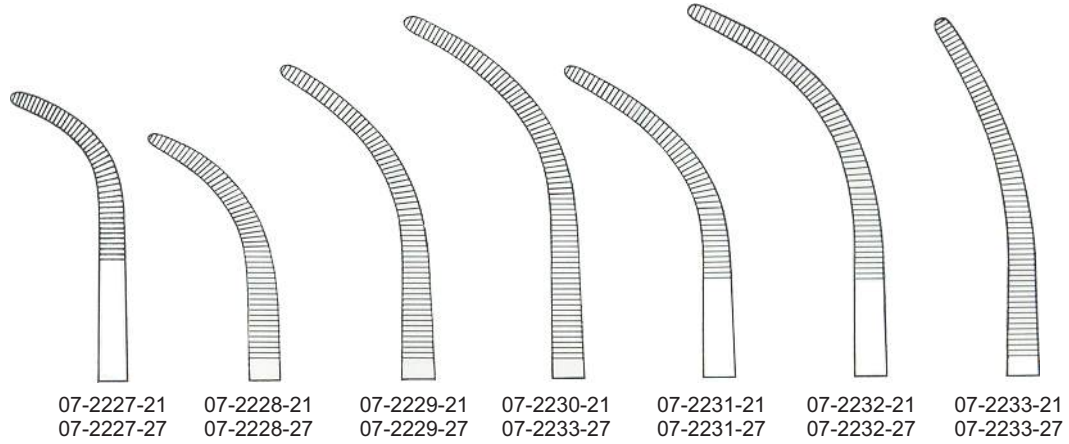

Overholt-Mixer
07-2234-21
21cm/8¼"

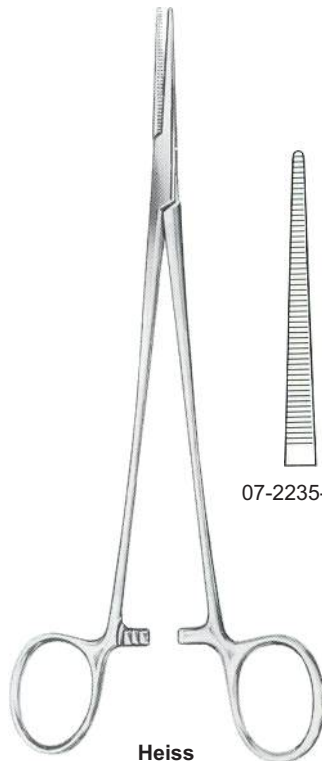

Heiss
20cm/8"

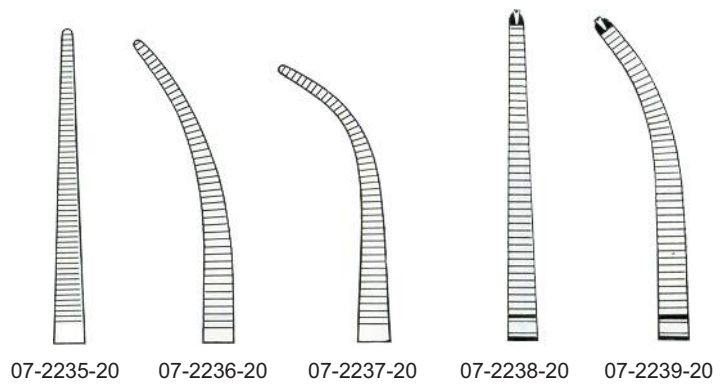

ARTERY FORCEPS



Meeker
 07-2240-27
 27 cm/10½"



Toennis
 21 cm/8¼"
 26 cm/10¼"

07-2241-21
 07-2242-27

07-2243-21
 07-2244-27

07-2245-21
 07-2246-27

07-2247-21
 07-2248-27



Lower
 07-2249-18
 18 cm/7"



Gemini

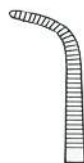

07-2250-13
 13 cm/5"



07-2251-18
 18 cm/7"

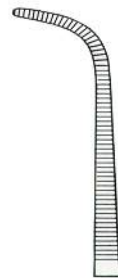

07-2252-20
 20 cm/8"



07-2253-23
 23 cm/9"



07-2254-25
 25 cm/10"



07-2255-27
 27 cm/10½"

ARTERY FORCEPS



Mini-Gemini

07-2256-18
18 cm/7"

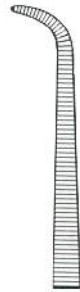

07-2256-22
22 cm/8¾"

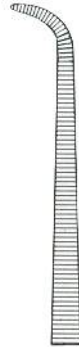

07-2256-25
25 cm/10"

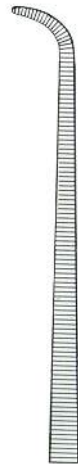

07-2256-28
28 cm/11"

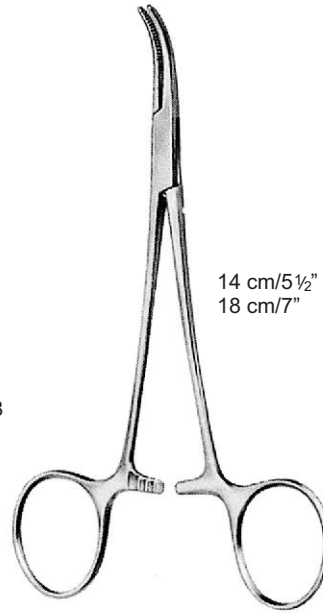

Baby-Mixer

14 cm/5½"
18 cm/7"



07-2257-14
07-2257-18



07-2258-14
07-2258-18



Mixer

07-2259-15 15 cm/6"
07-2259-19 19 cm/7½"



Mixer-O'Shaugnessy

07-2260-15 15.5 cm/6"
07-2260-19 19.0 cm/7½"

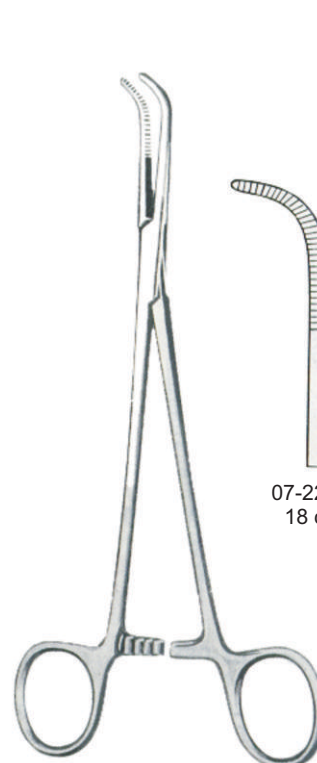

Mixer-Slim

07-2261-18
18 cm/7"



07-2261-23
23 cm/9"

ARTERY FORCEPS



07-2262-22
 22 cm/8¾"

Mixer



07-2262-25
 25 cm/10"

07-2262-28
 28 cm/11"



Mixer
 07-2263-22
 22 cm/8¾"



Wickstroem
 07-2264-20
 20 cm/8"



Finocchietto
 07-2265-24
 24 cm/9½"



Mc Quigg-Mixer
 07-2266-22
 22 cm/8¾"

ARTERY FORCEPS



Lawrence
07-2267-27
27.5 cm/10¾"



Lahey (Sweet)

07-2268-19
19 cm/7½"



07-2269-23
23 cm/9"



Spencer-Wells

- | | | |
|------------|----------|------------|
| 07-2270-13 | 13 cm/5" | 07-2271-13 |
| 07-2270-15 | 15 cm/6" | 07-2271-15 |
| 07-2270-18 | 18 cm/7" | 07-2271-18 |
| 07-2270-20 | 20 cm/8" | 07-2271-20 |
| 07-2270-23 | 23 cm/9" | 07-2271-23 |



Spencer-Wells



- | | | |
|------------|------------|------------|
| 07-2272-13 | 13 cm/5" | 07-2273-13 |
| 07-2272-14 | 14 cm/5 ½" | 07-2273-14 |
| 07-2272-15 | 15 cm/6" | 07-2273-15 |
| 07-2272-18 | 18 cm/7" | 07-2273-18 |
| 07-2272-20 | 20 cm/8" | 07-2273-20 |
| 07-2272-23 | 23 cm/9" | 07-2273-23 |

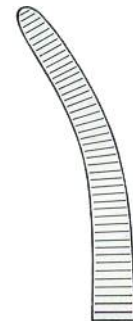

ARTERY FORCEPS



Rogers



07-2274-22
 22.5 cm/9"
 07-2274-25
 25.0 cm/10"



07-2275-22
 22.0 cm/8¾"
 07-2275-24
 24.5 cm/9¾"

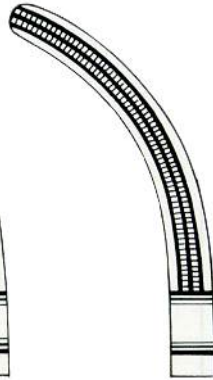

07-2276-21
 21.5 cm/8½"
 07-2276-24
 24.0 cm/9½"

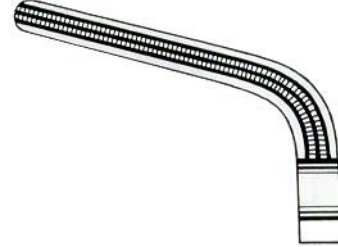

07-2277-20
 20.5 cm/8"
 07-2277-23
 23.5 cm/9"



Heaney

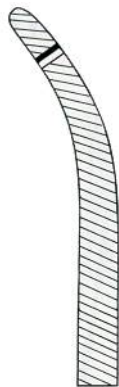

19.5 cm/7½" 07-2278-19
 21.5 cm/8¼" 07-2278-21
 23.5 cm/9" 07-2278-23



07-2279-19
 07-2279-21
 07-2279-23

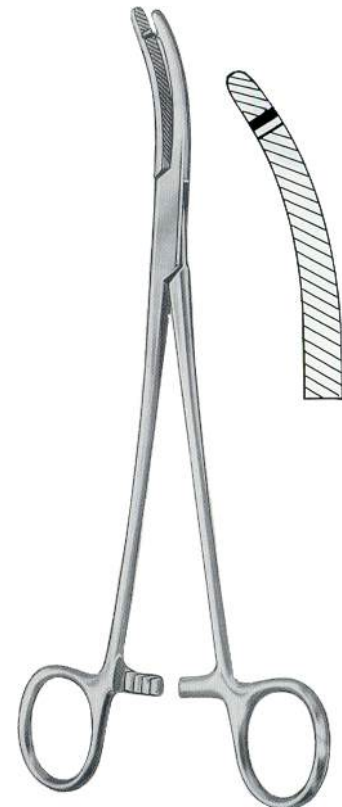

Heaney-Slim
 07-2280-21
 21 cm/8¼"

ARTERY FORCEPS



Ballentine
07-2281-21
21cm/8¼"



Heaney-Ballentine
07-2282-21
21cm/8¼"



Tonsil Forceps



Fig. 1



Fig. 2

Negus
07-2283-19 19cm/7½" 07-2284-19



Phaneuf
21.5cm/8½"



07-2285-21

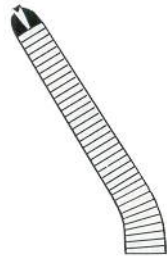

07-2286-21

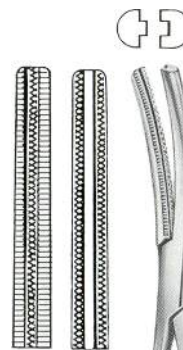

Haemorrhoidal Clamps

Straight

16cm/6¼" 07-2287-16
20cm/8" 07-2287-20

Curved

07-2288-16
07-2288-20

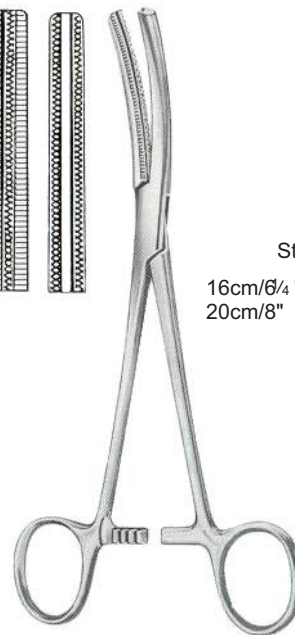

Fergusson

ARTERY FORCEPS

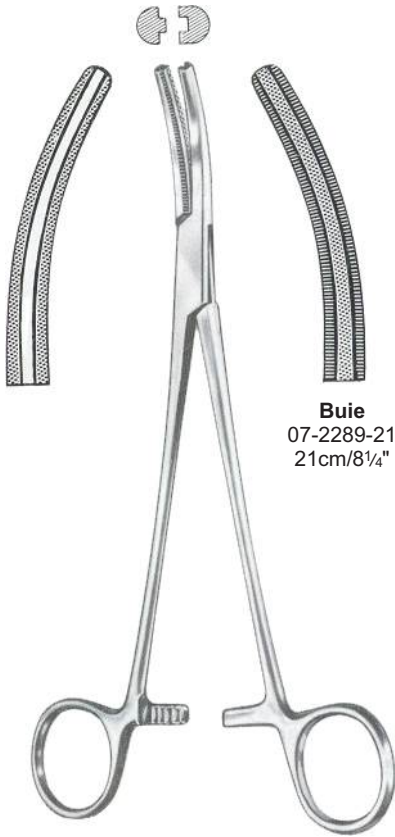

Buie
 07-2289-21
 21cm/8¼"

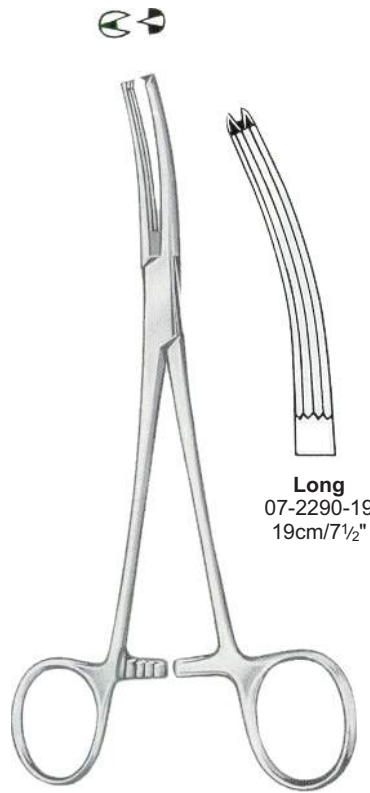

Long
 07-2290-19
 19cm/7½"



Garland
 07-2291-21
 21cm/8¼"

Gall Duct Clamps

Hysterectomy Forceps

Pressure Clamps



07-2292-23 23cm/9"
 07-2292-24 24cm/9½"
Moynihan



07-2293-23
 07-2294-23
Hozlbach
 23.5cm/9¼"



Zweifel
 07-2295-17
 17.5cm/7"

ARTERY FORCEPS

Scalp Flap Forceps



Martel
07-2296-14
14cm/5½"

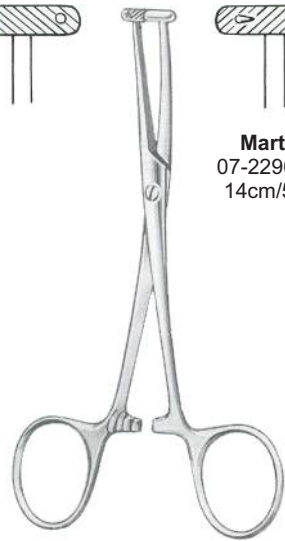

Wertheim
07-2297-25
25cm/10"



Wertheim-Cullen
07-2298-21
21.5cm/8½"

Extra Strong



Wertheim
07-2299-24
24cm/9½"

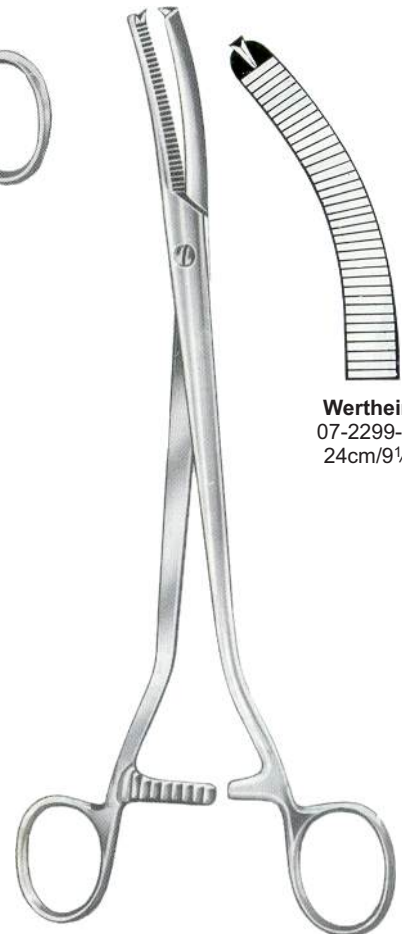

ARTERY FORCEPS

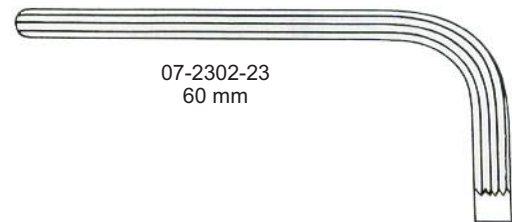
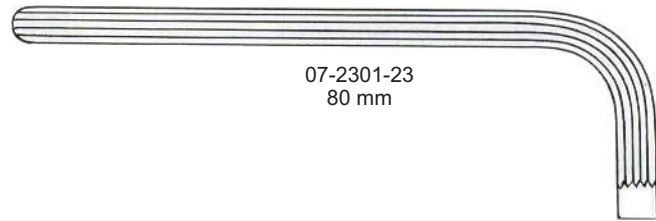
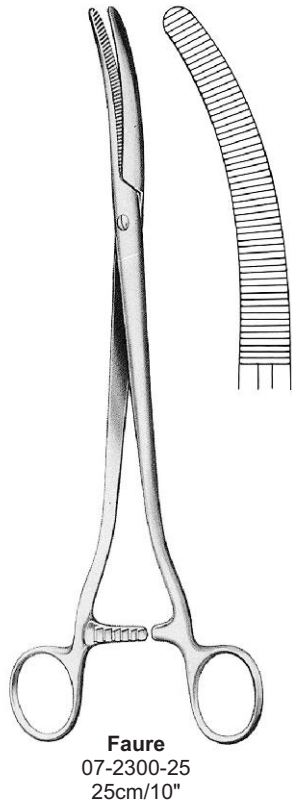

ARTERY FORCEPS

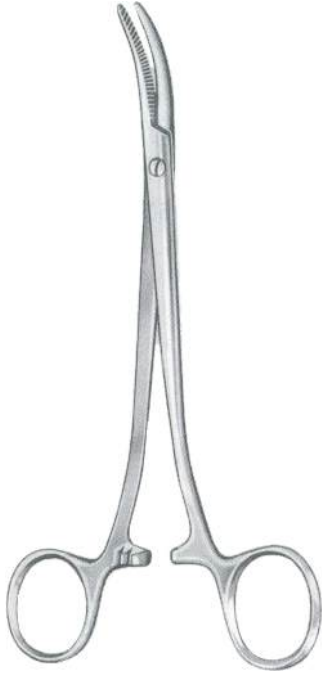

Werheim
07-2306-18
18 cm/7"

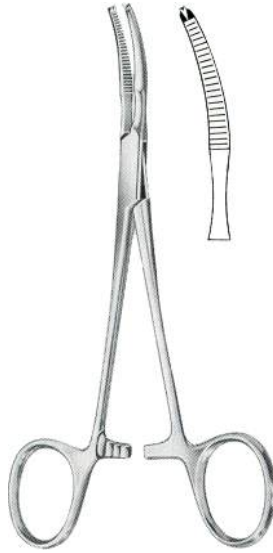

Baby-Mikulicz
07-2307-14
14 cm/5½"

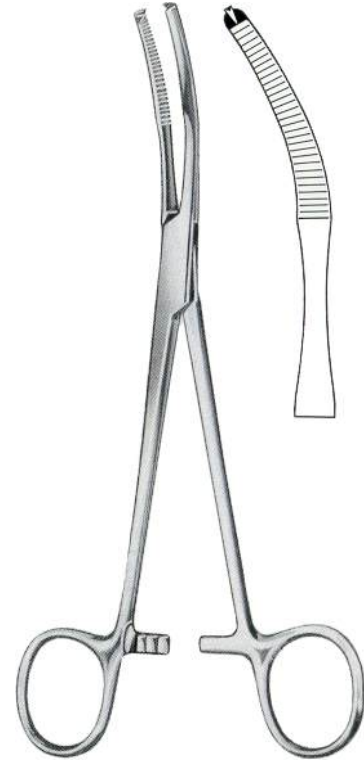

Mikulicz
07-2308-18 18cm/7"
07-2308-20 20cm/8"



Mikulicz
07-2309-20
20 cm/8"



Mikulicz
07-2310-18
18.5 cm/7¼"

ARTERY FORCEPS



Mikulicz
 07-2311-18
 18 cm/7"

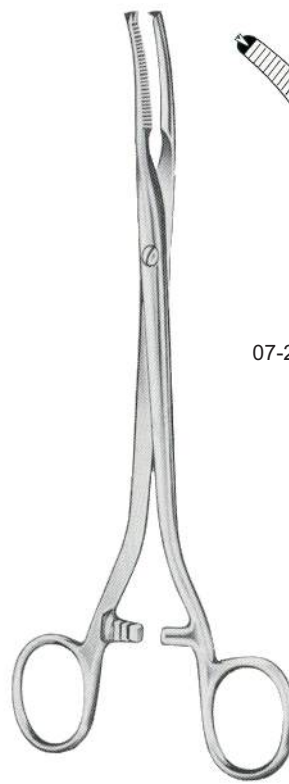

Mikulicz
 07-2312-20 20 cm/8" 07-2313-20

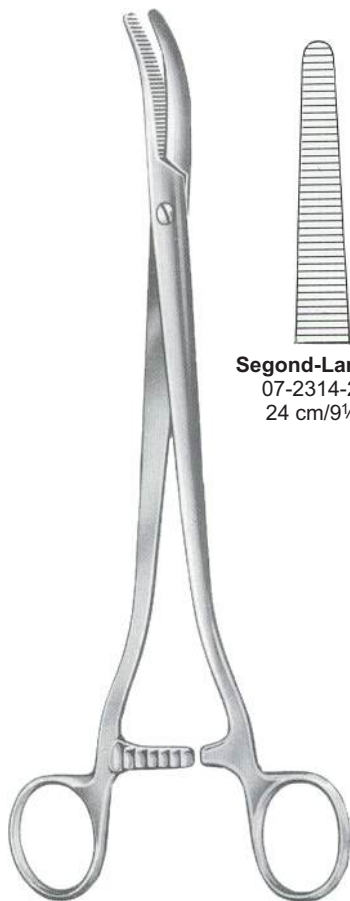

Segond-Landau
 07-2314-24
 24 cm/9½"



Segond
 07-2315-24
 24 cm/9½"

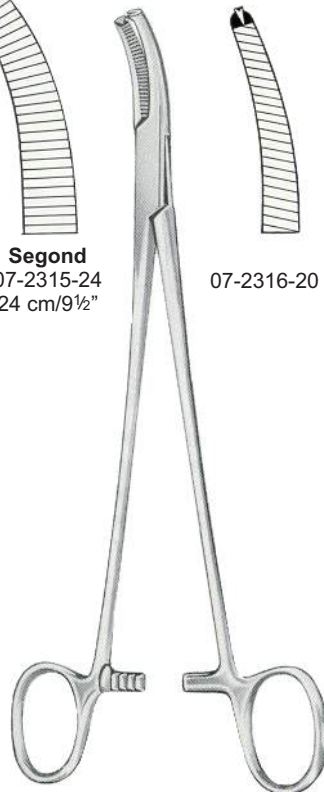

Faure
 07-2316-20 20 cm/8" 07-2317-20

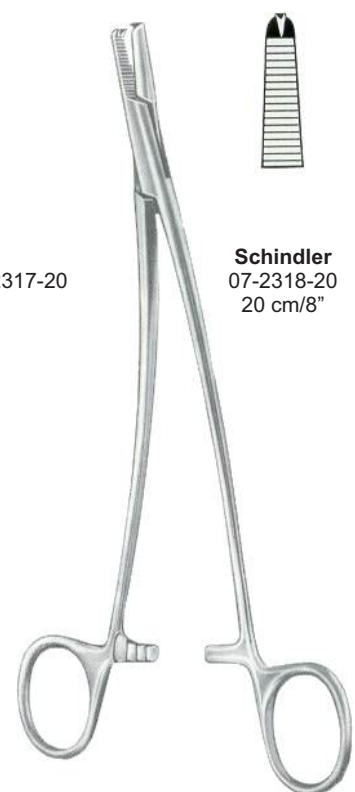

Schindler
 07-2318-20
 20 cm/8"

ARTERY FORCEPS



Schadel
 07-2319-09
 9 cm/3½"



Jones
 07-2320-05 5 cm/2"
 07-2320-09 9 cm/3 ½"



Engl-Modell
 07-2321-09
 9 cm/3½"



Backhaus
 07-2322-09 9 cm/3 ½"
 07-2322-11 11 cm/4 ½"
 07-2322-13 13 cm/5"
 07-2322-15 15 cm/6"

With clip for Tubing or Cable



07-2323-11 11 cm/4 ½"
 07-2323-13 13 cm/5"



Peers-Bertram
 07-2324-14
 14.5 cm/5¾"



Tohoku
 07-2325-10 10 cm/4"
 07-2325-13 13 cm/5"

ARTERY FORCEPS



Roder
 07-2326-13 13 cm/5"
 07-2326-15 15 cm/6"

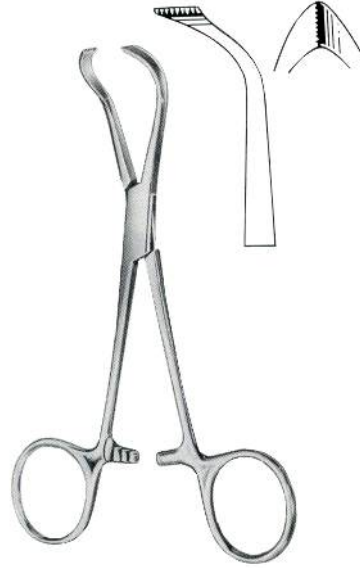

Lorna
 07-2327-10 10 cm/4"
 07-2327-13 13 cm/5"

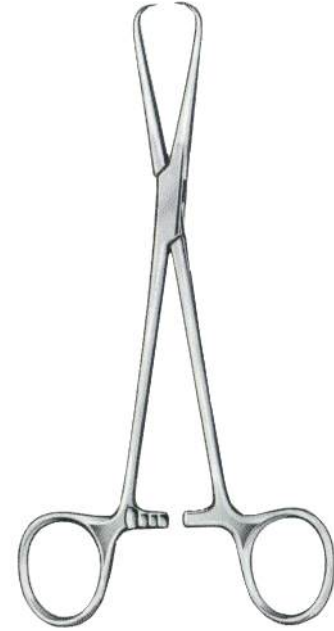

Bernhard
 07-2328-16 16.5 cm/6 ½



Lane
 07-2329-20
 20 cm/8"



Doyen
 07-2330-18
 18 cm/7"

ARTERY FORCEPS



07-2331-14 14 cm/5 1/2"
 07-2331-15 15 cm/6"
 07-2331-18 18 cm/7"
 07-2331-20 20 cm/8"



07-2332-14
 14.5 cm/5 3/4"

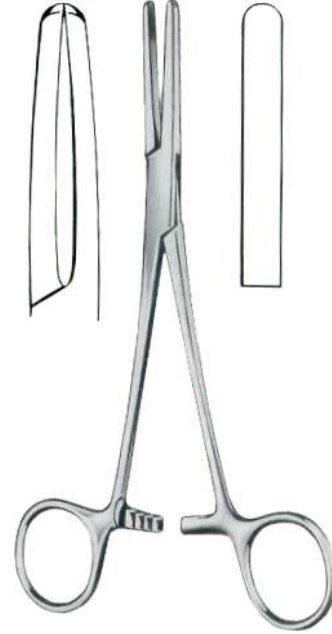

07-2333-16 16.5 cm/6 1/2"
 07-2333-18 18.0 cm/7"



07-2334-15 15 cm/6"
 07-2334-18 18 cm/7"
 07-2334-20 20 cm/8"



Mohr
 07-2335-50 50 mm
 07-2335-60 60 mm
 07-2335-70 70 mm
 07-2335-80 80 mm

Sizes
 mm
 13
 17
 20
 25
 30

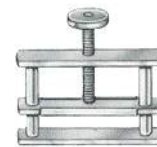

Hoffmann
 07-2336-13
 07-2336-17
 07-2336-20
 07-2336-25
 07-2336-30



Hoffmann
 07-2337-13
 07-2337-17
 07-2337-20
 07-2337-25
 07-2337-30

EN

Cotton Swab Forceps

DE

Tupfer-und Kornzangen

ES

Pinzas para tapones y curaciones

Page 141 to 144

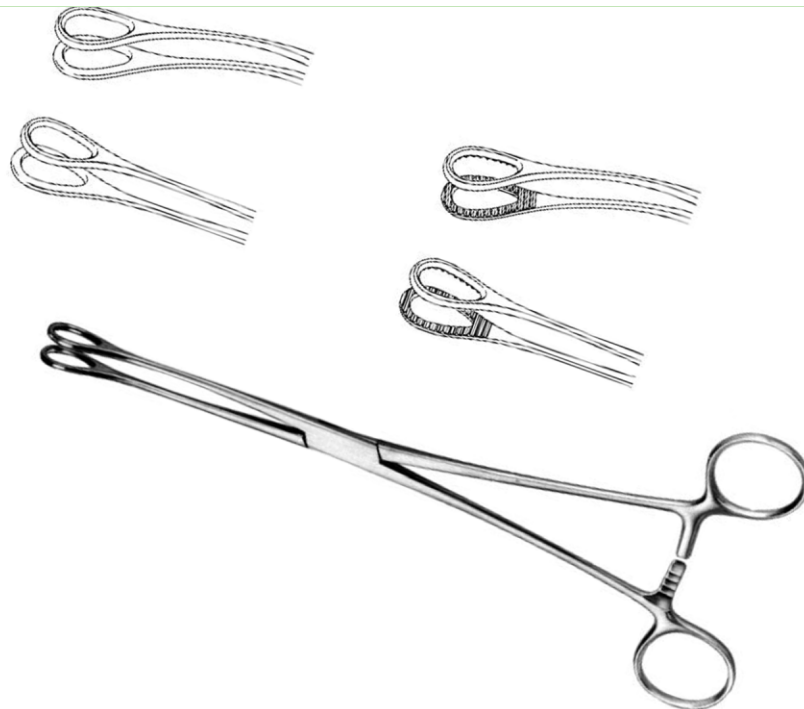

COTTON SWAB FORCEPS



Ulrich

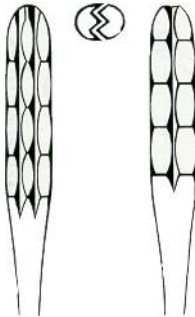

Straight

08-2401-22
08-2401-25
08-2401-27

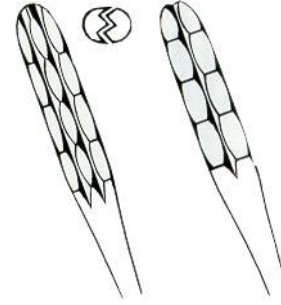

Curved

22 cm/8¾"
25 cm/10"
27 cm/10½"

08-2402-22
08-2402-25
08-2402-27



Lister

08-2403-13	13 cm/5"	08-2404-13
08-2403-15	15 cm/6"	08-2404-15
08-2403-18	18 cm/7"	08-2404-18



Bryant

08-2405-13
13 cm/5"



Bryant

08-2406-13
13 cm/5"

COTTON SWAB FORCEPS



Gross-Maier

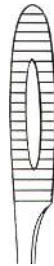

Straight

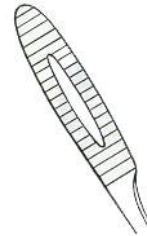

Curved

With Ratchet

08-2407-20	20 cm/8"	08-2408-20
08-2407-25	25 cm/10"	08-2408-25

Without Ratchet

08-2409-20	20 cm/8"	08-2410-20
08-2409-25	25 cm/10"	08-2410-25



Pelkman
25 cm/10"

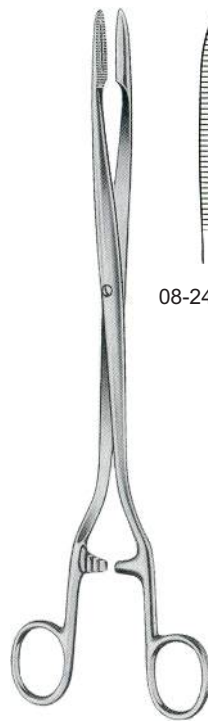
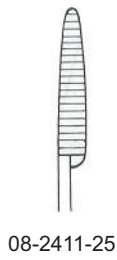

Sims-Maier
28 cm/11"

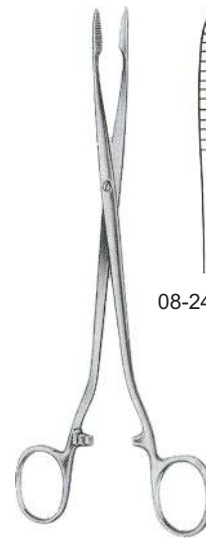
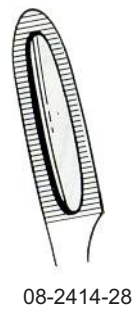

Duplay
20 cm/8"

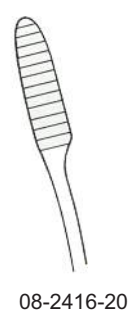

COTTON SWAB FORCEPS

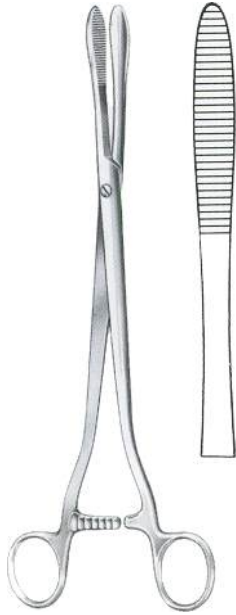

Collin
08-2417-25
25cm/10"

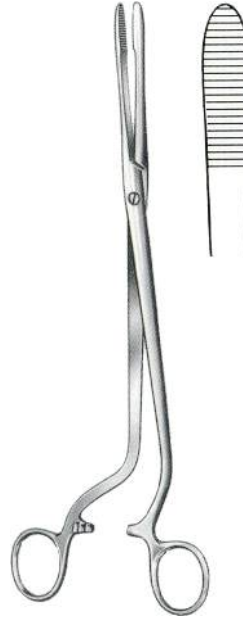

Cheron
08-2418-25
25cm/10"



Emmet
08-2419-21
21cm/8¼"



Bozemann
08-2420-26
26cm/10¼"



Bozemann
26cm/10¼"



08-2421-26



08-2422-26

Smooth

COTTON SWAB FORCEPS

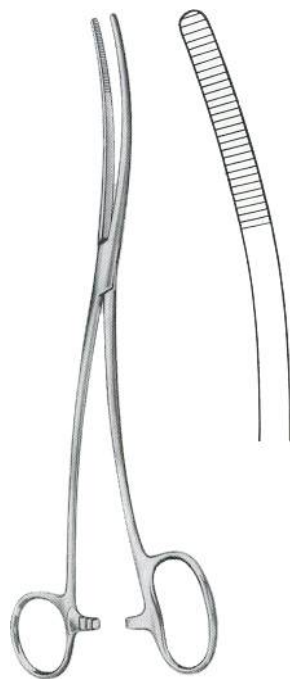

Bozemann-Douglas
 08-2423-26
 26cm/10¼"

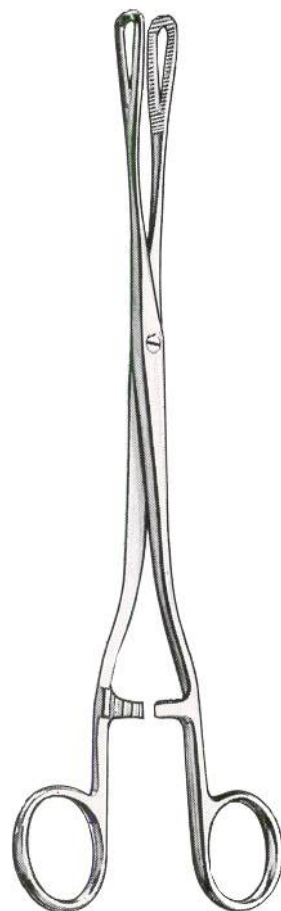

Rampley
 08-2424-18 18cm/7"
 08-2424-24 24cm/9 ½"



Rampley
 08-2425-18 18cm/7"
 08-2425-24 24cm/9 ½"



Foerster

18 cm/7"
 20 cm/8"
 24 cm/9 ½"
 25 cm/10"



08-2426-18
 08-2426-20
 08-2426-24
 08-2426-25

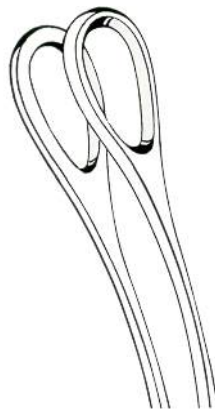

08-2427-18
 08-2427-20
 08-2427-24
 08-2427-25

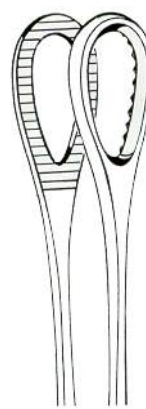

08-2428-18
 08-2428-20
 08-2428-24
 08-2428-25

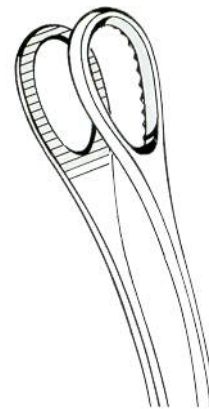

08-2429-18
 08-2429-20
 08-2429-24
 08-2429-25

EN Suture

DE Naht

ES Sutura

Page 145 to 175



SUTURE



Derf
09-2501-12 12.0cm

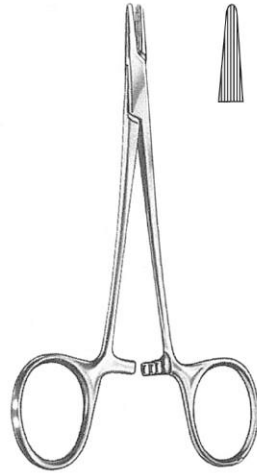

Derf
09-2502-12 12.5cm

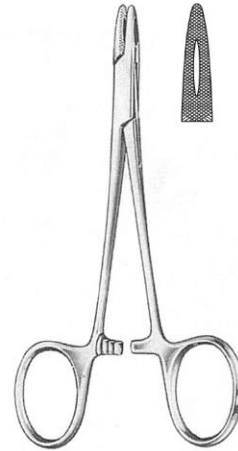

Collier
09-2503-12 12.5cm

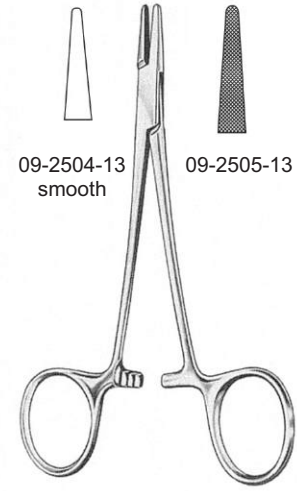

09-2504-13 smooth
09-2505-13
Webster
13.0cm

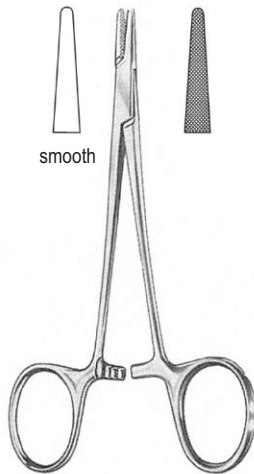

smooth
Halsey
09-2506-13 13.0cm 09-2507-13

smooth jaws with special groove

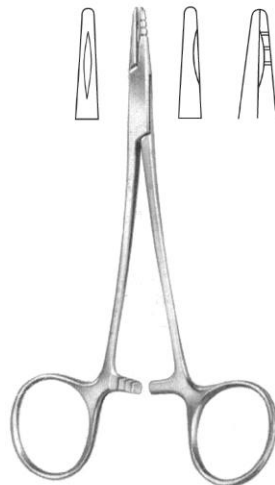

Neivert
09-2508-13 13.0cm



Hegar-Baumgartner
09-2509-12 12.5cm
09-2509-14 14.0cm

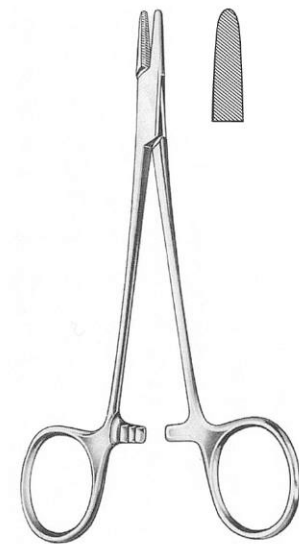

Brown
09-2510-13 13.0cm
09-2510-18 18.0cm

SUTURE



Mayo-Hegar

- | | |
|-------------------|------------|
| 09-2511-14 14.0cm | 09-2512-14 |
| 09-2511-15 15.0cm | 09-2512-15 |
| 09-2511-16 16.0cm | 09-2512-16 |
| 09-2511-18 18.0cm | 09-2512-18 |
| 09-2511-20 20.0cm | 09-2512-20 |
| 09-2511-22 22.0cm | 09-2512-22 |
| 09-2511-24 24.0cm | 09-2512-24 |
| 09-2511-26 26.0cm | 09-2512-26 |
| 09-2511-28 28.0cm | 09-2512-28 |
| 09-2511-30 30.0cm | 09-2512-30 |



delicate pattern

Mayo-Hegar

- | |
|-------------------|
| 09-2513-16 16.0cm |
| 09-2513-18 18.0cm |
| 09-2513-20 20.0cm |



Crile-Murray

- | |
|-------------------|
| 09-2514-15 15.0cm |
|-------------------|



Crile-Wood

- | |
|-------------------|
| 09-2515-15 15.0cm |
| 09-2515-18 18.0cm |
| 09-2515-20 20.0cm |

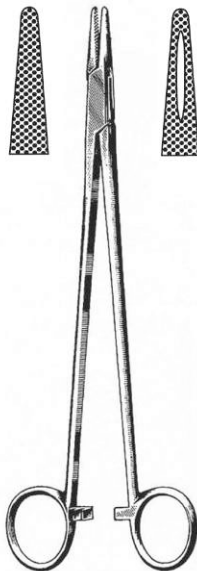

Hegar

- | | |
|-------------------|------------|
| 09-2516-20 20.0cm | 09-2517-20 |
| 09-2516-24 24.0cm | 09-2517-24 |

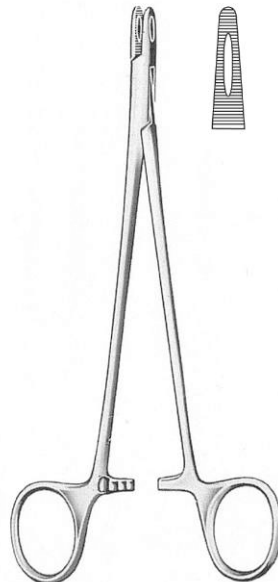

Adson

- | |
|-------------------|
| 09-2518-18 18.0cm |
|-------------------|

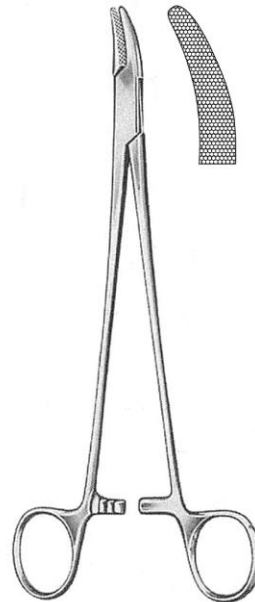

Heaney

- | |
|-------------------|
| 09-2519-21 21.0cm |
|-------------------|

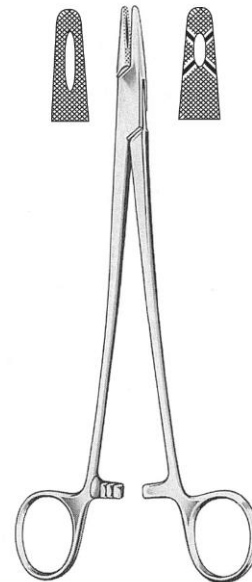

Metzenbaum

- | |
|-------------------|
| 09-2520-18 18.0cm |
|-------------------|

SUTURE

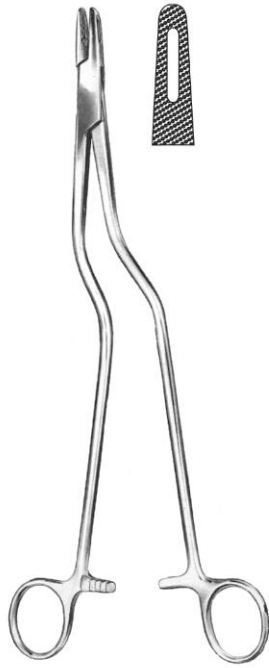

Masson-Luethy
09-2521-26 26.0cm

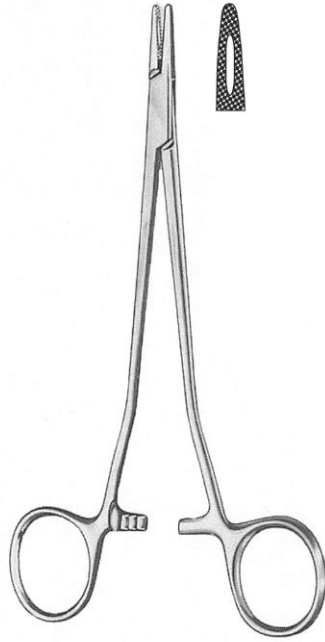

Sarot
09-2522-18 18.0cm
09-2522-26 26.0cm

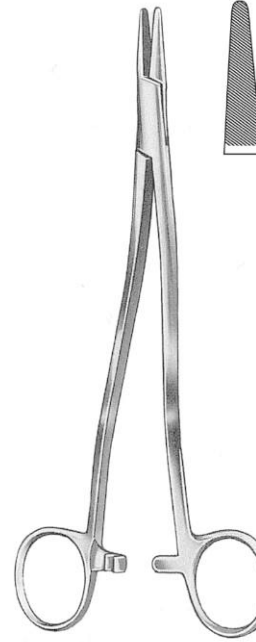

Wertheim
09-2523-20 20.0cm
09-2523-24 24.0cm



Stratte
09-2524-23 23.0cm



Bruce-Clarke
09-2525-12 12.5cm

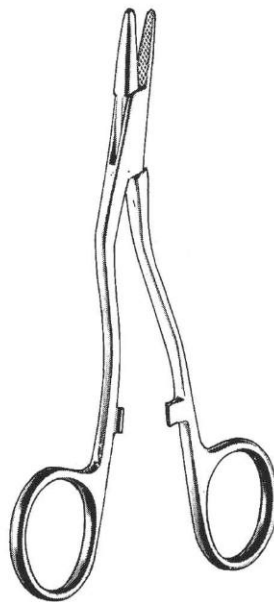

Kilner
09-2526-13 13.5cm
09-2526-16 16.5cm

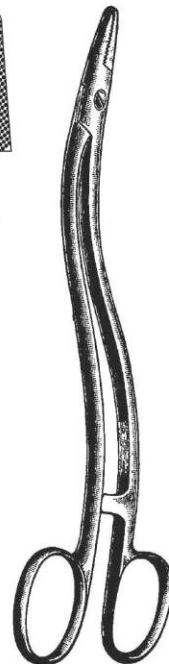

Thomson-Walker
09-2527-20 20.0cm

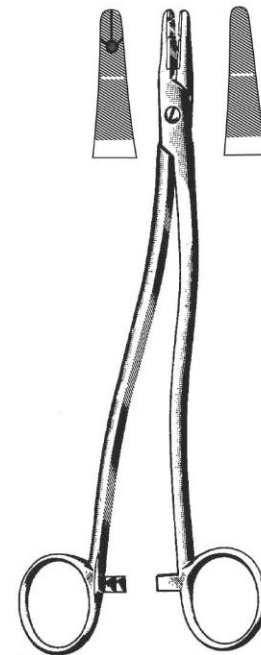

Bozemann
09-2528-20 20.0cm
09-2528-24 24.0cm

SUTURE

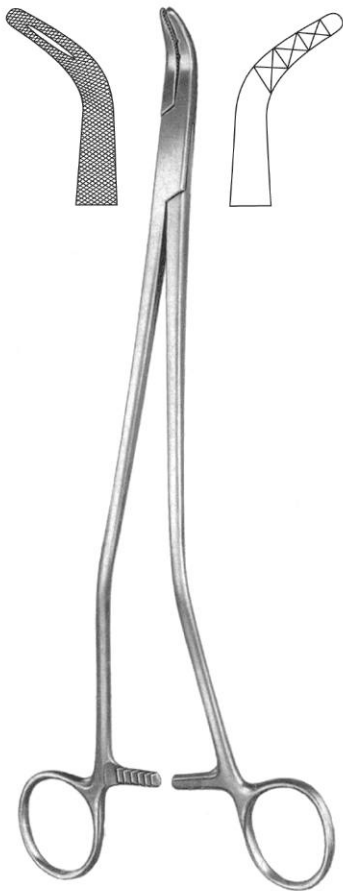

Johnson
 09-2529-27 27.0cm

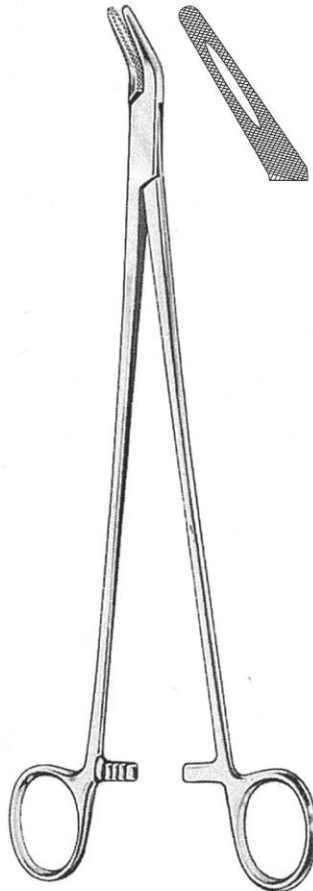

Finocchietto
 09-2530-18 18.0cm
 09-2530-20 20.0cm
 09-2530-27 27.0cm

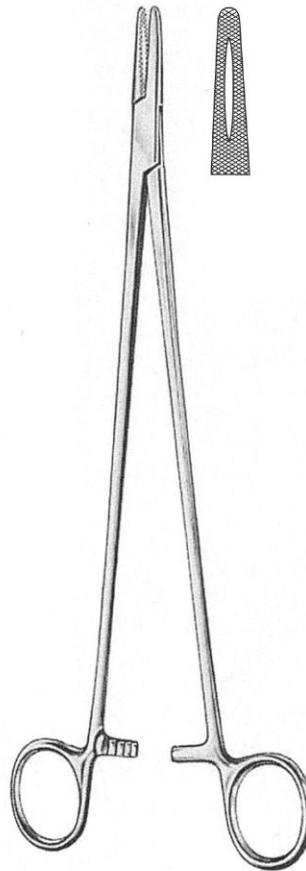

Masson
 09-2531-27 27.0cm

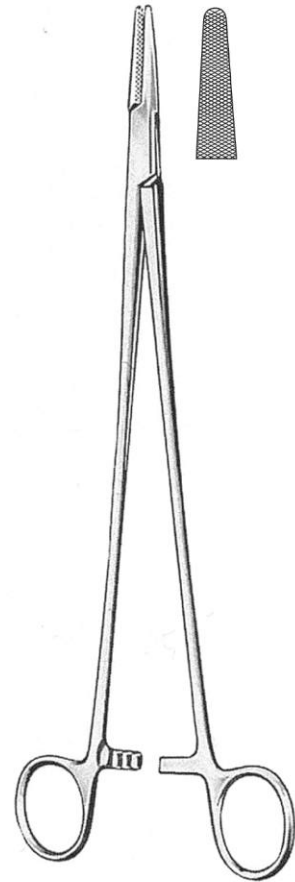

Wangenstein
 09-2532-27 27.0cm

SUTURE

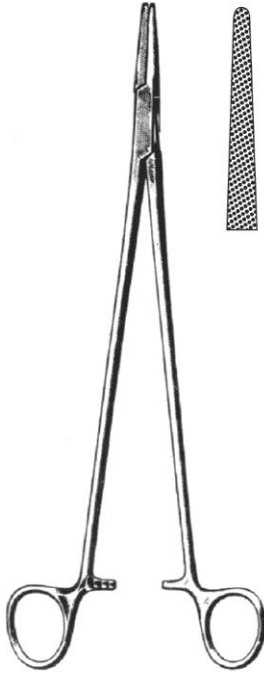

Wangensteen
09-2533-27 27.0cm

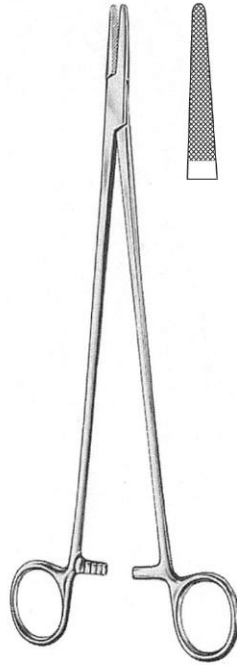

Jamison
09-2534-23 23.5cm

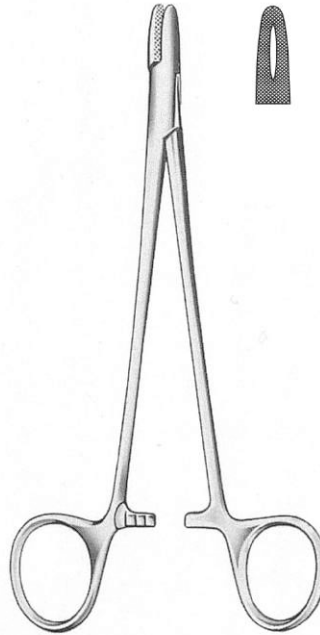

M.G.H.(mass-general-hospital)
09-2535-17 17.0cm

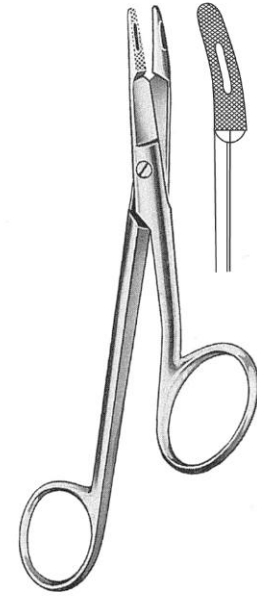

Gillies
09-2536-16 16.0cm (right hand)
09-2536-16 16.0cm (left hand)

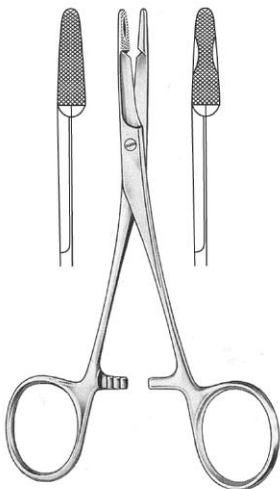

Olsen-Hegar
09-2537-14 14.0cm 09-2538-14
with blood groove



Olsen-Hegar
09-2539-17 17.0cm

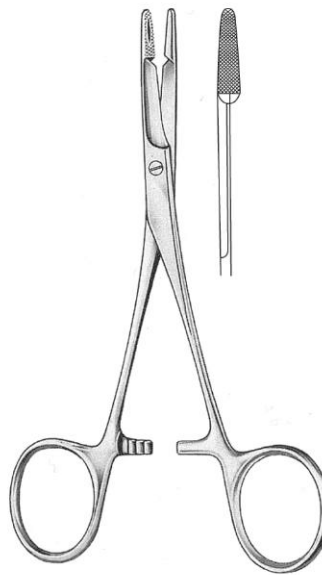

Olsen-Hegar
09-2540-17 17.0cm

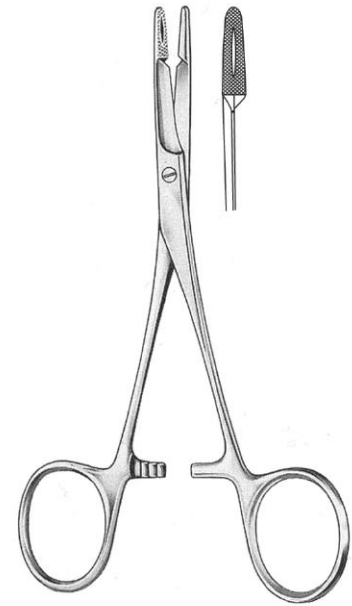

Olsen-Hegar
09-2541-14 14.0cm
09-2541-18 18.0cm

SUTURE



Crile
 09-2542-15 15.0cm

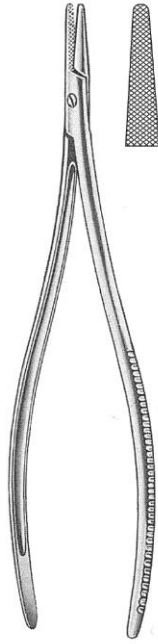

Toennis
 09-2543-18 18.0cm

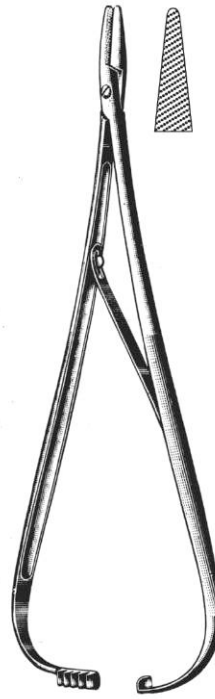

Lichtenberg
 09-2544-20 20.0cm

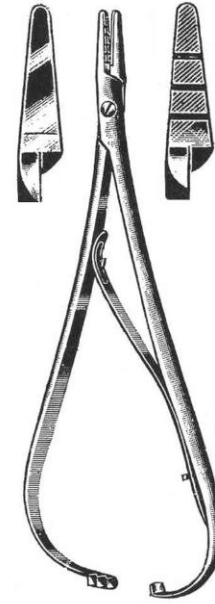

Macphail
 09-2545-14 14.0cm
 09-2545-16 16.0cm
 09-2545-18 18.0cm
 09-2545-20 20.0cm

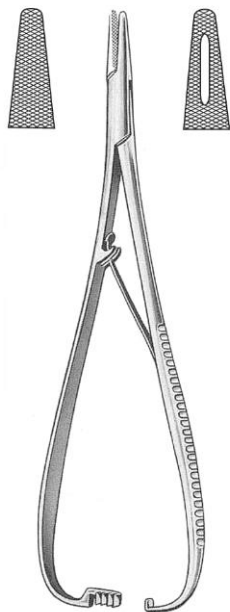

Mathieu
 09-2546-14 14.0cm 09-2547-14
 09-2546-17 17.0cm 09-2547-17
 09-2546-20 20.0cm 09-2547-20
 09-2546-24 24.0cm 09-2547-24

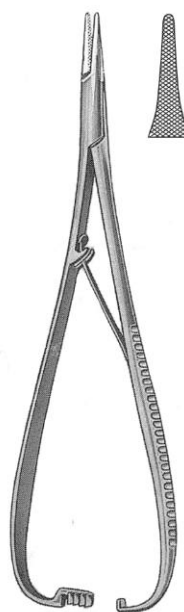

Mathieu
 09-2548-14 14.0cm
 09-2548-17 17.0cm



Mathieu
 09-2549-17 17.0cm
 09-2549-20 20.0cm

SUTURE

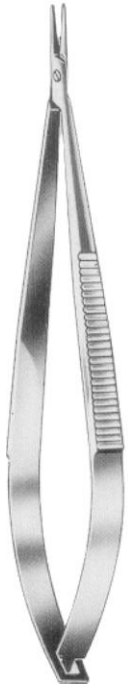

Castroviejo
14cm/5 1/2"



Castroviejo

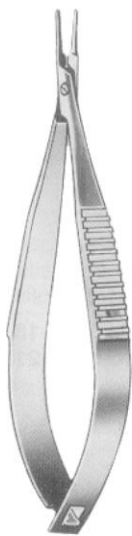

Castroviejo
9cm/3 1/2"

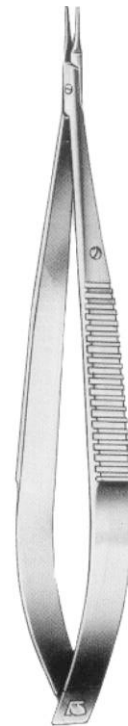

Castroviejo
14cm/5 1/2"



SUTURE



Castroviejo
9 cm/3 1/2"

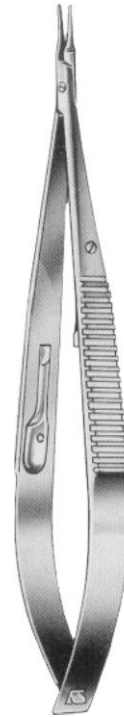

Castroviejo
14 cm/5 1/2"



Paton
09-2560-11
11.5 cm/4 1/2"

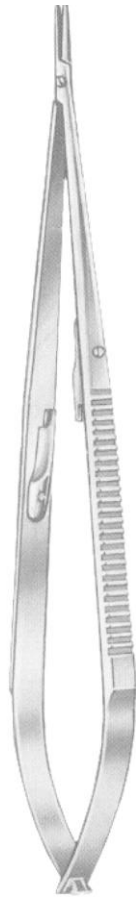

Jacobson

cm	in	Without ratchet	With ratchet
18	7"	09-2561-18	09-2562-18
21	8 1/4"	09-2561-21	09-2562-21

SUTURE

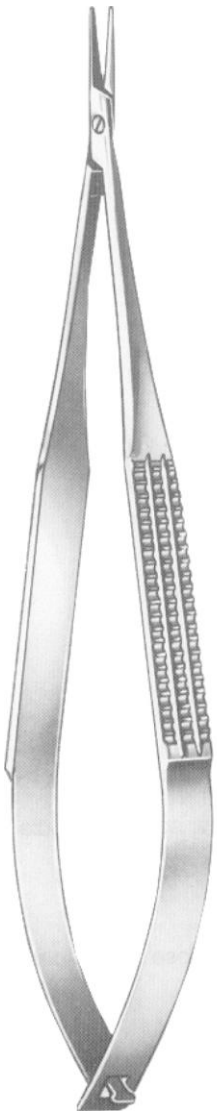

Straight
09-2563-15
15 cm/6"

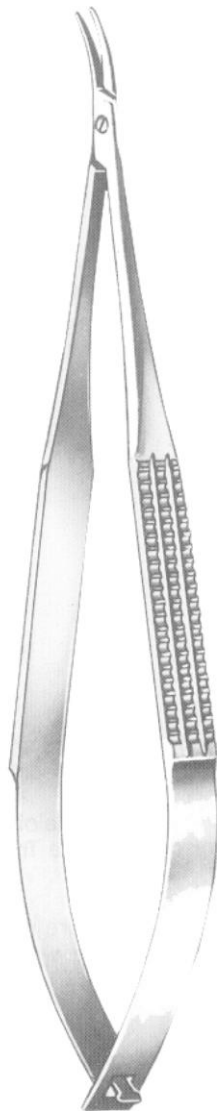

Curved
09-2564-15
15 cm/6"

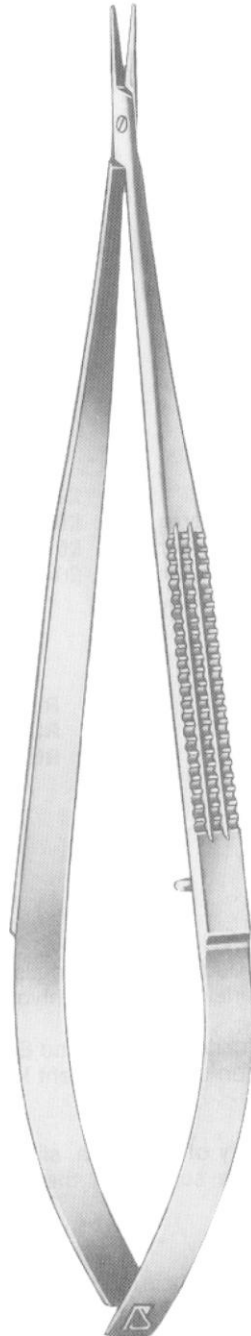

Straight
09-2565-18
18 cm/7"

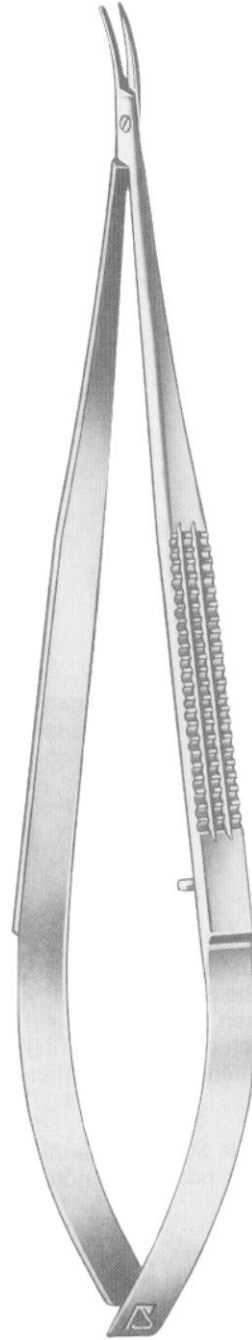

Curved
09-2566-18
18 cm/7"

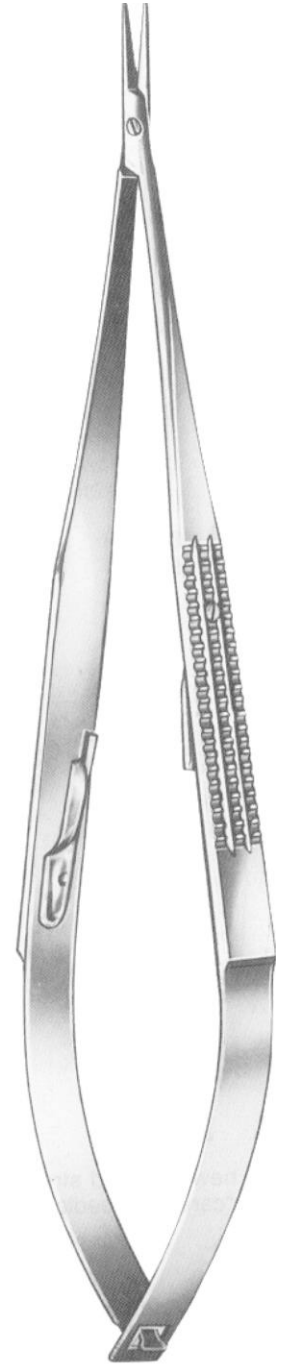

Straight
09-2567-18
18 cm/7"

SUTURE

Straight

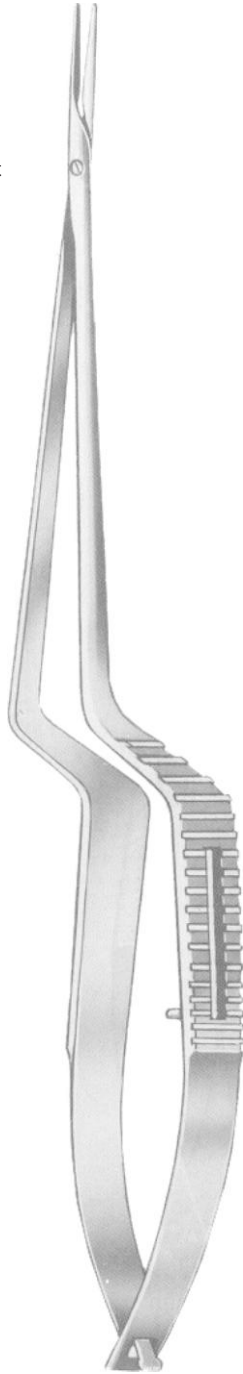

09-2568-18
 09-2568-22

Curved

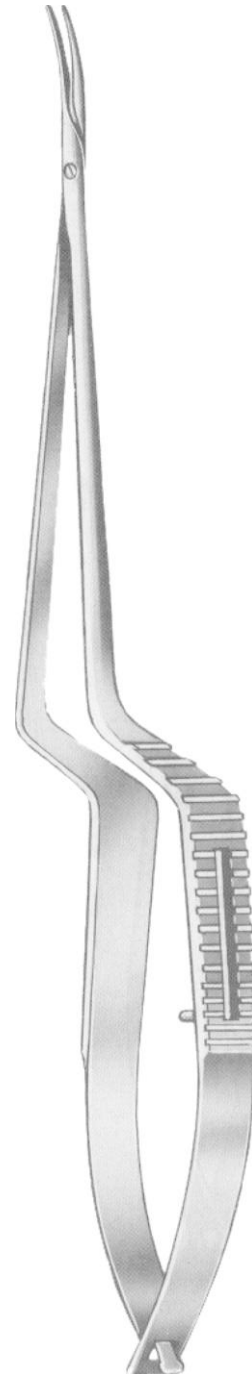

09-2569-18
 09-2569-22

Yasargil
 18.0 cm/7"
 22.5 cm/8¾"

SUTURE

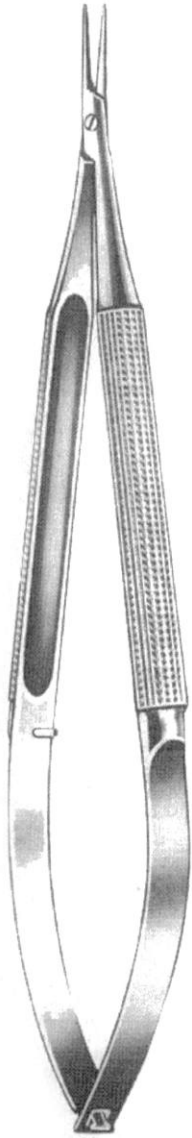

Straight
09-2570-15
15 cm/6"

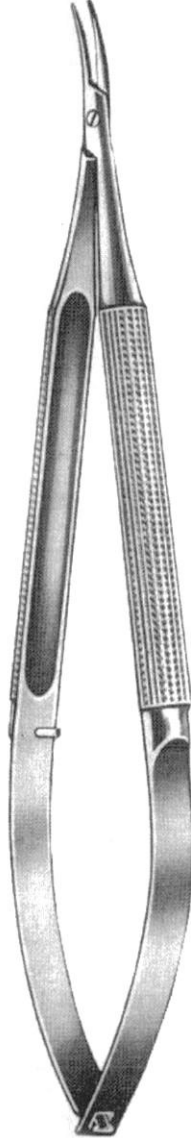

Curved
09-2571-15
15 cm/6"



Straight
09-2572-15
15 cm/6"

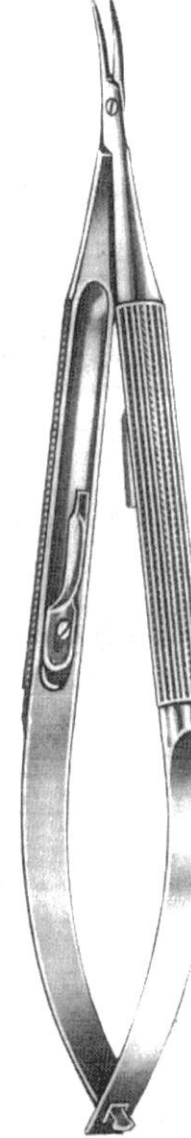

Curved
09-2573-15
15 cm/6"

SUTURE

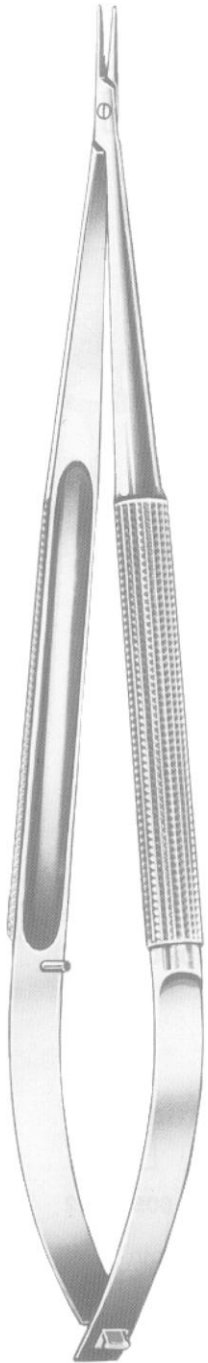

Straight
 09-2574-18
 18.5 cm/7¼"

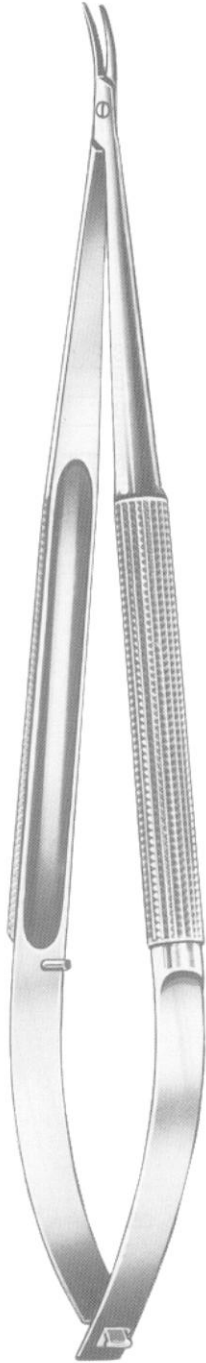

Curved
 09-2575-18
 18.5 cm/7¼"

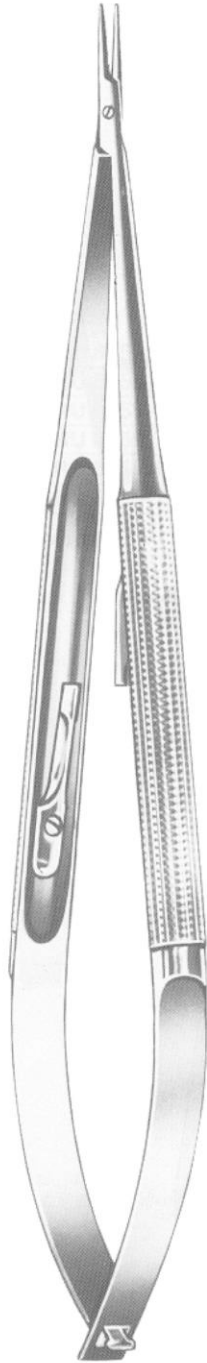

Straight
 09-2576-18
 18.5 cm/7¼"

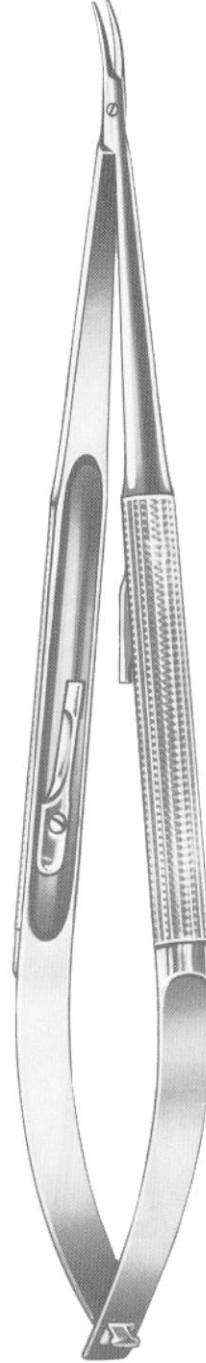

Curved
 09-2577-18
 18.5 cm/7¼"



23 cm/9"



Straight
 09-2578-23



Curved
 09-2579-23

SUTURE



Straight
09-2580-12
12 cm/4¾"



Curved
09-2581-12
12 cm/4¾"



Angled
09-2582-12
12 cm/4¾"

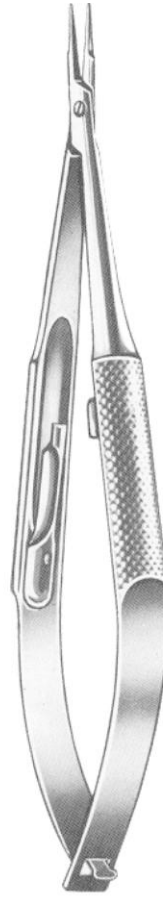

Straight
09-2583-12
12 cm/4¾"

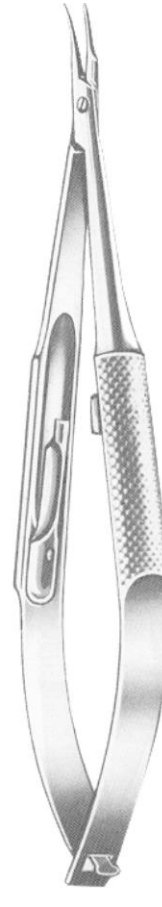

Curved
09-2584-12
12 cm/4¾"

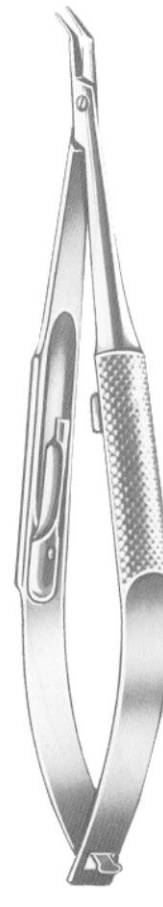

Angled
09-2585-12
12 cm/4¾"

SUTURE

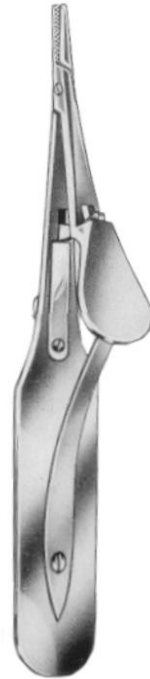

Arruga
 14 cm/5½"

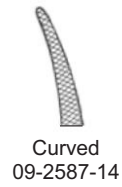
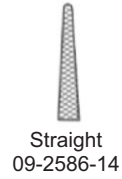

Stevens
 09-2588-13 13 cm/5"
 09-2588-15 15 cm/6"



Kalt
 09-2589-14
 14 cm/5½"



Castroviejo-Kalt
 09-2590-13
 13.5 cm/5¼"



Kalt-Arruga
 09-2591-14
 14 cm/5½"

SUTURE

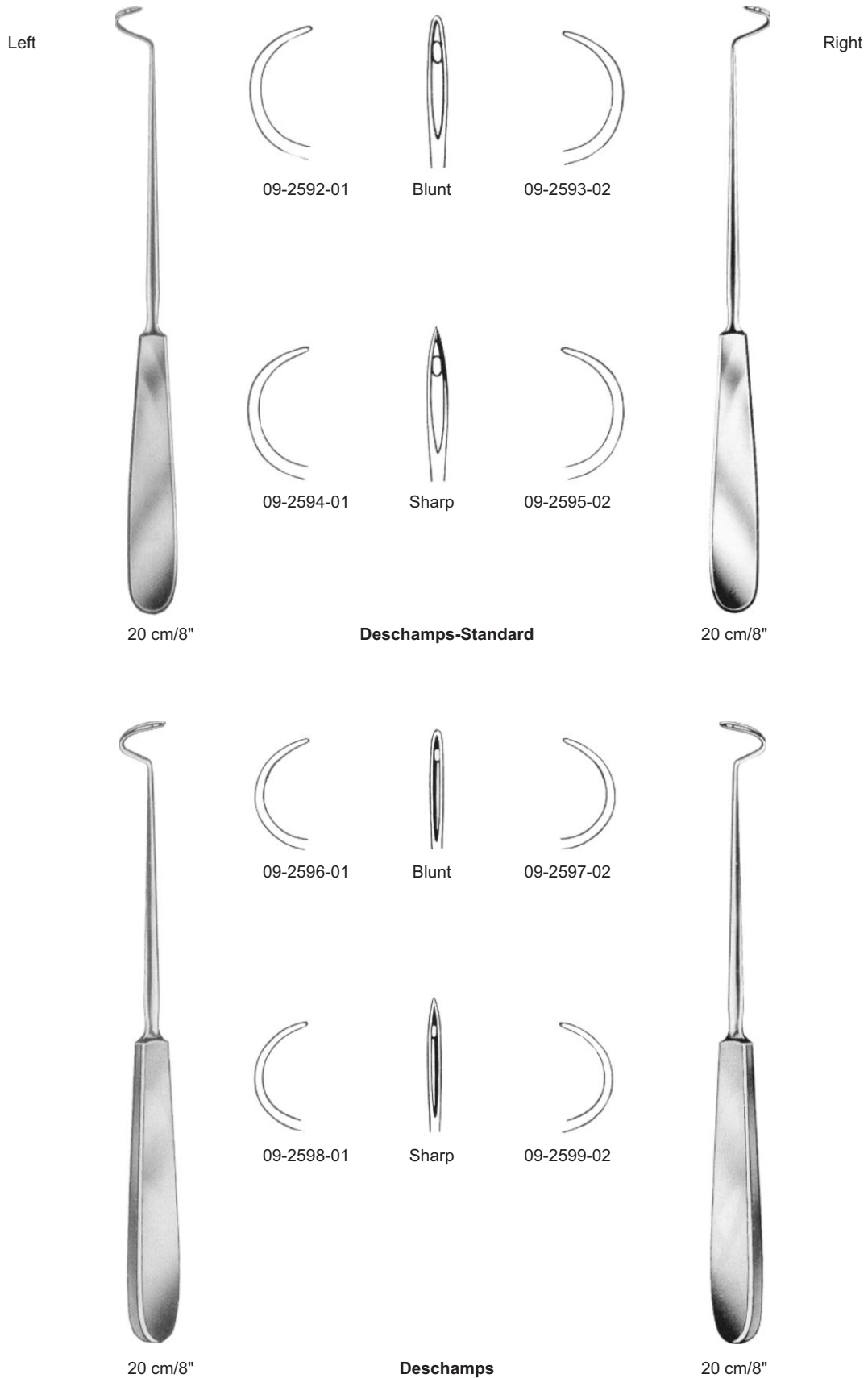

SUTURE

Left Right

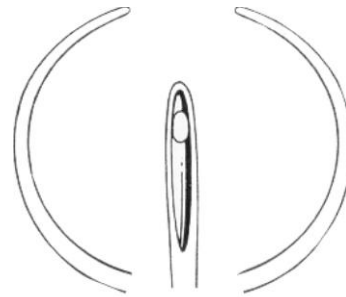

Left

Right

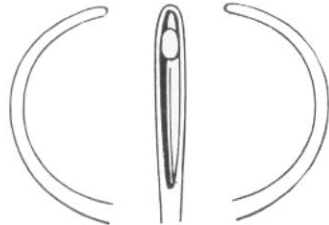

09-2600-01 Blunt 09-2601-02

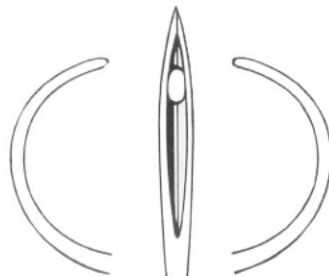

09-2602-01 Sharp 09-2603-02

21cm/8¼"

Deschamps

21 cm/8¼"

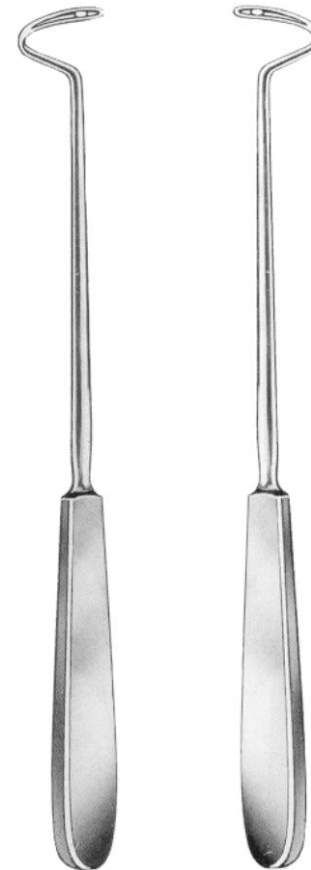

Deschamps
 24 cm/9½"
 09-2604-01 09-2605-02

SUTURE

Left Right

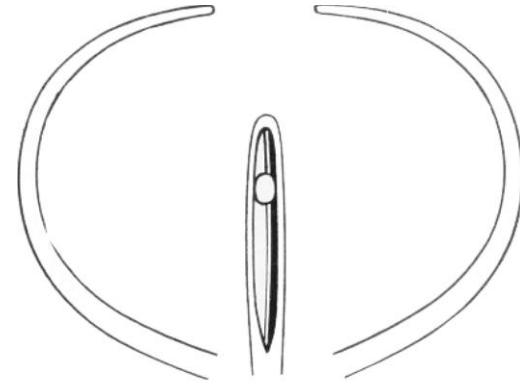

Left

Right

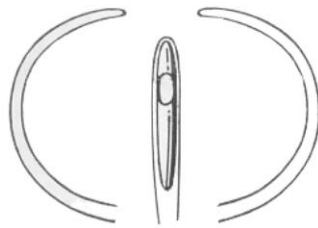

Blunt
09-2606-01 09-2607-02

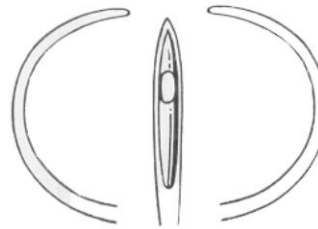

Sharp
09-2608-01 09-2609-02



27 cm/10½"

Deschamps

27 cm/10½"



Deschamps
09-2610-01 28 cm/11" 09-2611-02

SUTURE



09-2612-01

09-2613-02

09-2614-03

Kocher
19 cm/7½"

Left

Right



Kronecker

09-2615-01 13 cm/5" 09-2616-02

Left

Right



Dupuy-Weiss

09-2617-01 22 cm/8¾" 09-2618-02

Left

Right

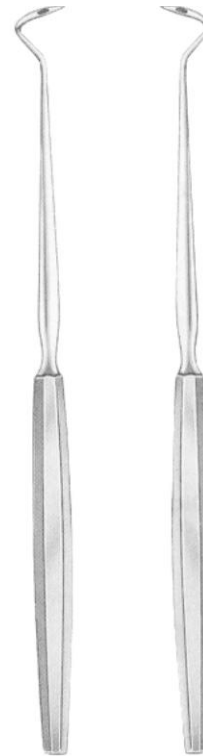

Durham

09-2619-01 21 cm/8¼" 09-2620-02

SUTURE

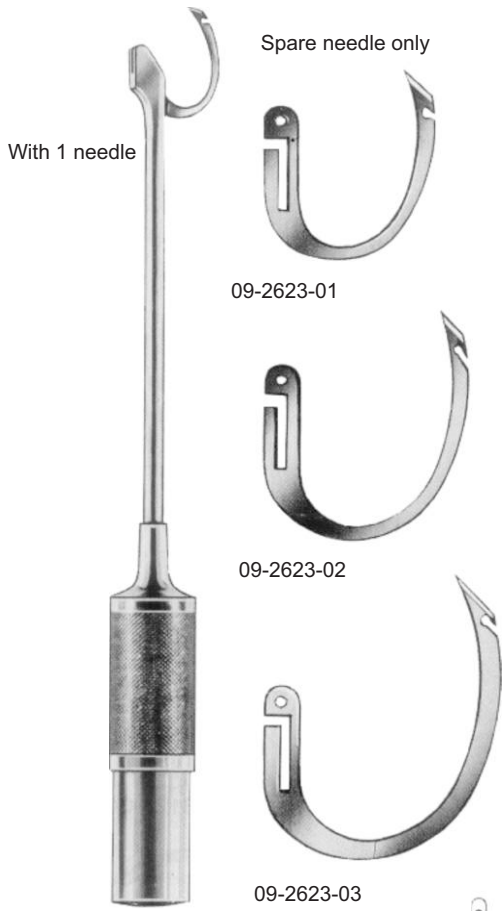

Young
09-2621-21 21 cm/8¼"
09-2622-25 25 cm/10"

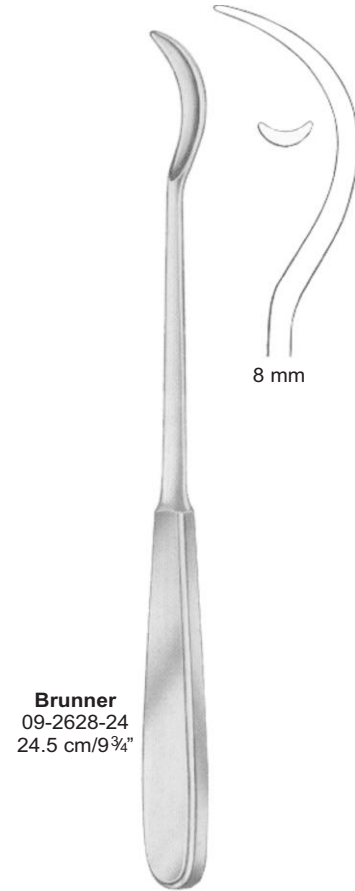
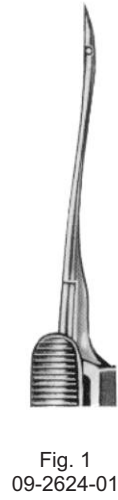

SUTURE



Reverdin
 19.5 cm / 7³/₄"



Fig. 1
 09-2629-01



Fig. 2
 09-2629-02



Fig. 3
 09-2629-03



Fig. 4
 09-2629-04



Reverdin
 22.5 cm / 8³/₄"



Fig. 1
 09-2630-01



Fig. 2
 09-2630-02



Fig. 3
 09-2630-03



Fig. 4
 09-2630-04

SUTURE



Castroviejo

14cm/5½"
18cm/7"
21cm/8¼"



09-2631-14
09-2631-18
09-2631-21

Smooth



09-2632-14
09-2632-18
09-2632-21



14cm/5½"
18cm/7"
21cm/8¼"

09-2633-14
09-2633-18
09-2633-21



09-2634-14
09-2634-18
09-2634-21



Kalt
14cm/5½"



09-2635-14



09-2636-14



Barraquer
09-2637-14
14cm/5 ½"



Castroviejo
09-2638-13
13cm/5"

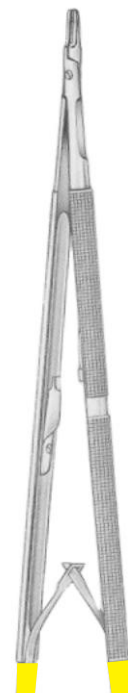

Hepp-Schiedel
18cm/7"



09-2639-18



09-2640-18

Smooth

SUTURE

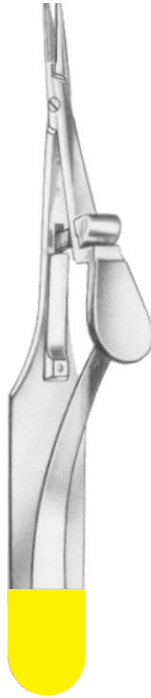

Arruga
14cm/5½"

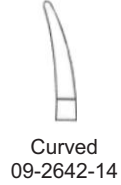

Jacobson
 09-2643-18 18cm/7"
 09-2643-20 20cm/8"
 09-2643-23 23cm/8¾"



Diethrich

Straight		Curved
09-2644-16	16cm/6¼"	09-2645-16
09-2644-18	18cm/7"	09-2645-18
09-2644-20	20cm/8"	09-2645-20
09-2644-23	23cm/9"	09-2645-23
09-2644-25	25cm/10"	09-2645-25

SUTURE

Two rings angled

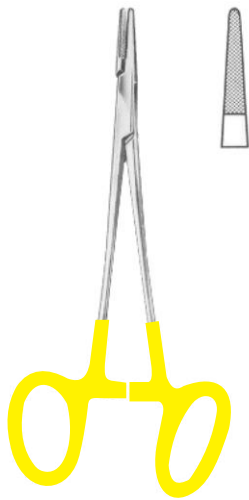

Neivert
09-2646-13
13 cm/5"

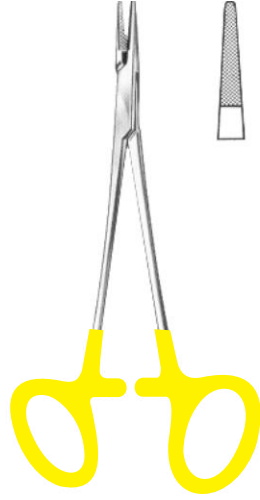

Neivert
09-2647-13
13 cm/5"

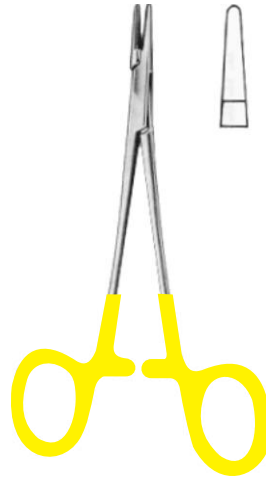

Webster
09-2648-13
13 cm/5"

Smooth



Derf
09-2649-12
12.5 cm/5"



New Orleans
09-2650-18
18 cm/7"



Bozemann
09-2651-20 20 cm/8"
09-2651-24 24 cm/9 1/2"
09-2651-26 26 cm/10 1/2"

SUTURE



Mayo-Hegar

09-2652-16
 09-2652-18
 09-2652-20
 09-2652-24
 09-2652-26
 09-2652-30



09-2653-20
 09-2653-24
 09-2653-26

16cm/6¼"
 18cm/7"
 20cm/8"
 24cm/9½"
 26cm/10½"
 30cm/12"

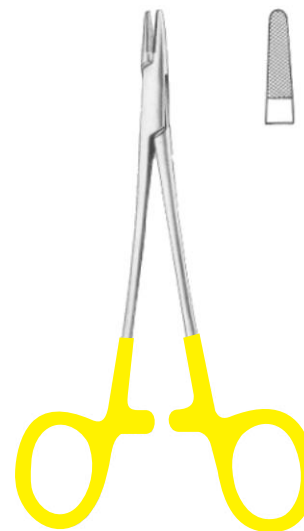

Hegar-Baumgartner

09-2654-14
 14cm/5½"

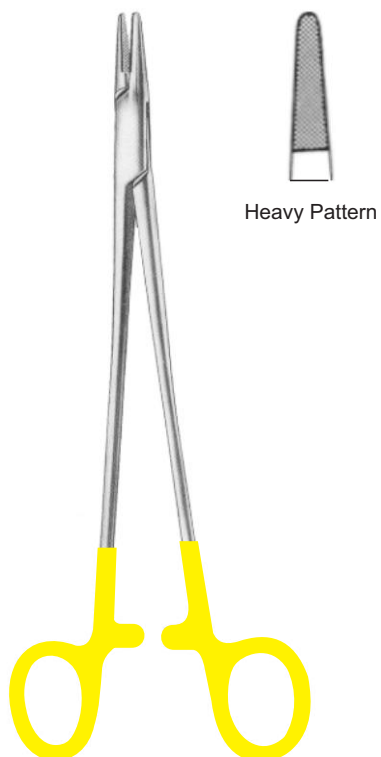

Heavy Pattern

Mayo-Hegar

09-2655-20 20cm/8"
 09-2655-24 24cm/9½"



De Bakey

09-2656-18
 09-2656-20
 09-2656-23
 09-2656-26
 09-2656-31

18cm/7"
 20cm/8"
 23cm/9"
 26cm/10¼"
 31cm/12¼"



De Bakey-Fine

09-2657-18
 09-2657-20
 09-2657-23
 09-2657-26
 09-2657-31

SUTURE

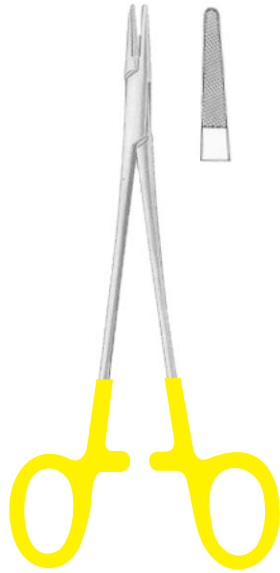

Baby-Crile-Wood
09-2658-15
15cm/6"

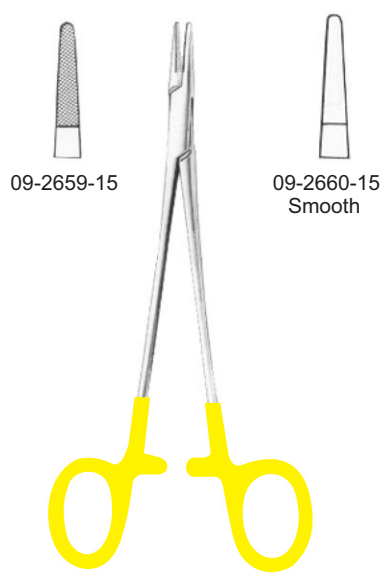

Crile-Wood
15cm/6"

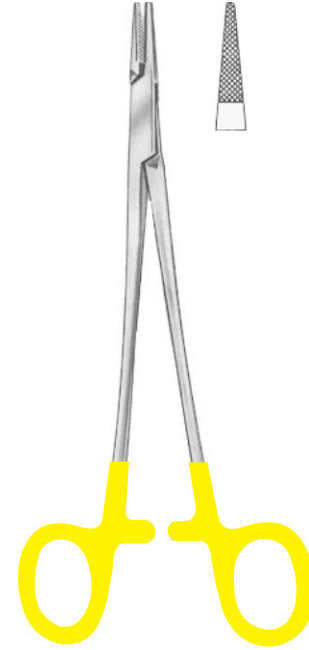

Crile-Wood

	cm	in
09-2661-18	18	7"
09-2661-20	20	8"
09-2661-23	23	9"
09-2661-26	26	10 1/4"
09-2661-31	31	12 1/4"

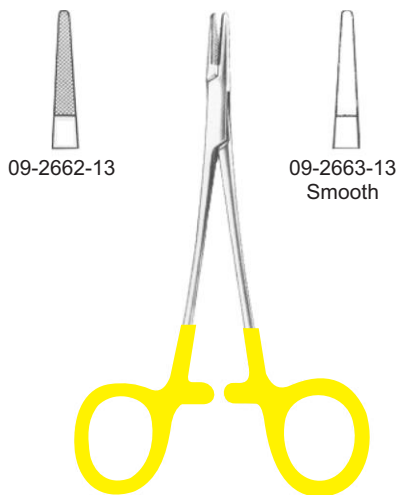

Halsey
13cm/5"

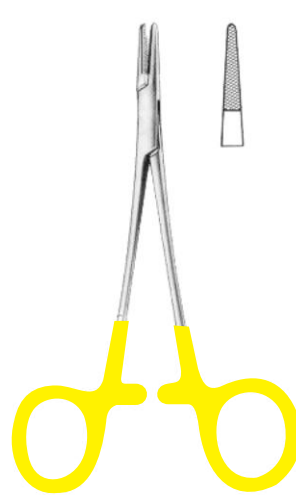

Converse
09-2664-12
12.5cm/5"

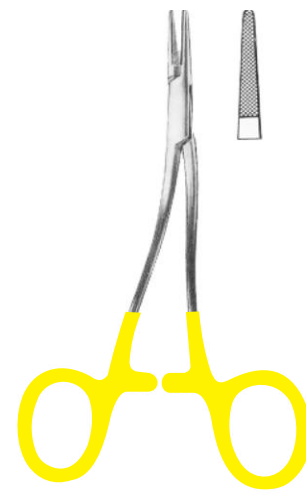

Kilner
09-2665-13
13.5cm/5 1/4"

SUTURE

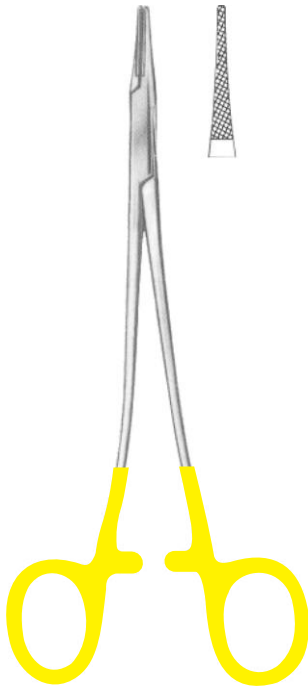

Hegar-Vascular
 09-2666-14 14cm/5½"
 09-2666-18 18cm/7"
 09-2666-20 20cm/8"
 09-2666-23 23cm/9"

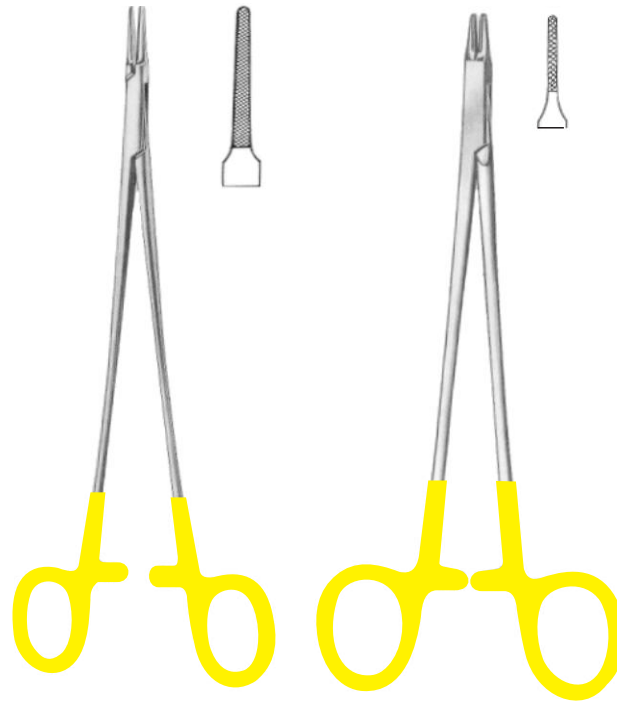

Ryder		Micro-Ryder	
09-2667-13	13cm/5"	09-2668-13	13cm/5"
09-2667-15	15cm/6"	09-2668-15	15cm/6"
09-2667-18	18cm/7"	09-2668-18	18cm/7"
09-2667-20	20cm/8"	09-2668-20	20cm/8"
09-2667-23	23cm/9"	09-2668-23	23cm/9"
09-2667-26	26cm/10¼"	09-2668-26	26cm/10¼"

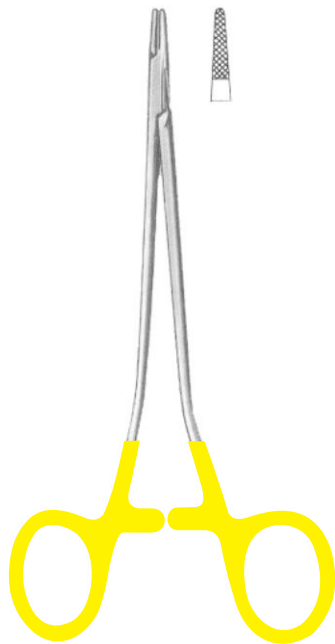

(Swedish Pattern)
 09-2669-15 15cm/6"
 09-2669-17 17cm/6¾"
 09-2669-20 20cm/8"



Sarot
 09-2670-18 18cm/7"
 09-2670-26 26cm/10¼"

SUTURE

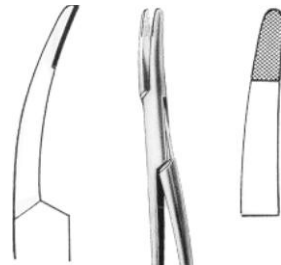

Stratte
09-2671-23
23cm/9"



Masson
09-2672-27
27cm/10½"



Wangenstein
09-2673-27
27cm/10½"



Finocchetto
09-2674-20 20cm/8"
09-2674-27 27cm/10½"

SUTURE



Mathieu

14cm/5½"	09-2675-14
17cm/6¾"	09-2675-17
20cm8"	09-2675-20
24cm/9½"	09-2675-24



Mathieu

09-2676-14
09-2676-17
09-2676-20
09-2676-24



Mathieu-Ryder

09-2677-17
09-2677-20



Langenbeck

16cm/6¼"	09-2678-16
18cm/7"	09-2678-18
20cm/8"	09-2678-20



Langenbeck-Ryder

09-2679-18
09-2679-20



Lichtenberg

09-2680-20

SUTURE



Toennis
09-2681-18
18 cm/7"



Mathieu-Kocher
09-2682-14 14 cm/5 1/2"
09-2682-17 17 cm/6 3/4"
09-2682-20 20 cm/8"



Axhausen
09-2683-18
18.5 cm/7 1/4"



Zweifel
09-2684-20 20 cm/8"
09-2684-23 23 cm/9"

SUTURE



09-2685-20 20 cm/8"
 09-2685-25 25 cm/10"



Mathieu
 09-2686-20 20 cm/8"
 09-2686-24 24 cm/9½"



Metzenbaum
 09-2687-17 17 cm/6¾"
 09-2687-20 20 cm/8"



Arruga
 16 cm/6¼"

09-2688-16



09-2689-16



Boynton
 09-2690-12
 12 cm/4¾"



Hosel
 09-2691-20 20 cm/8"
 09-2691-25 25 cm/10"

SUTURE



Baby-Olsen-Hegar
 09-2692-11
 11.5 cm/4½"



Olsen-Hegar
 09-2693-14
 14 cm/5½"



Olsen-Hegar
 09-2694-17
 17 cm/6¾"



Olsen-Hegar
 09-2695-18
 18 cm/7"



Gillies-Slim
 09-2696-14
 14.5 cm/5½"

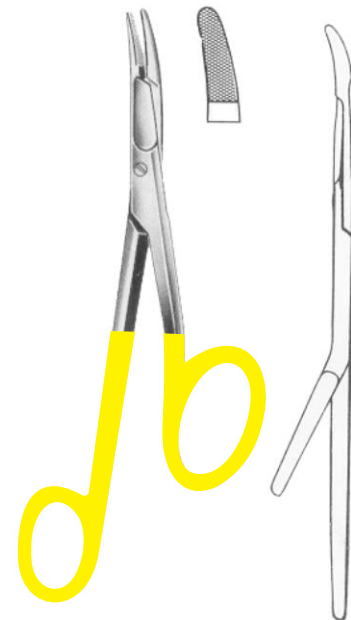

Gillies
 09-2697-16 (right hand)
 09-2698-16 (left hand)
 16 cm/6¼"

EN Probes, Applicators, Spatulas

DE Sonden, Watteträger, Spatel

ES Sondas, Porta-algodones, Espátulas

Page 176 to 181



PROBES, APPLICATORS, SPATULAS

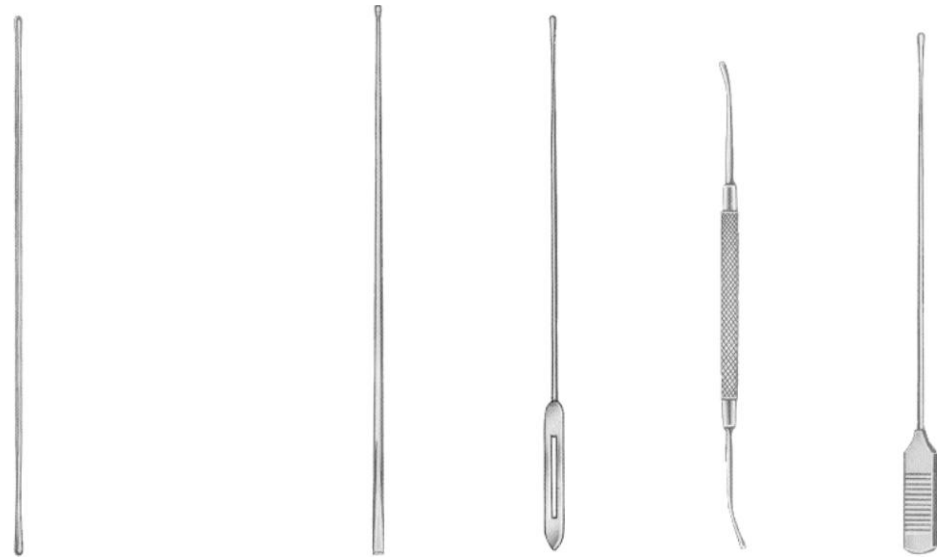

cm	In	1.0 mmØ	1.5 mmØ	2.0 mmØ	2.0 mmØ	Watson-Cheyne	Fish
11.5	4 1/2"	10-2851-11	10-2852-11	10-2853-11			
13	5"	10-2851-13	10-2852-13	10-2853-13		10-2855-13	
14.5	5 3/4"	10-2851-14	10-2852-14	10-2853-14	10-2854-14	10-2855-14	10-2857-14
16	6 1/4"	10-2851-16	10-2852-16	10-2853-16	10-2854-16	10-2855-16	
18	7"	10-2851-18	10-2852-18	10-2853-18		10-2855-18	10-2857-18
20	8"	10-2851-20	10-2852-20	10-2853-20		10-2855-20	
25	10"	10-2851-25	10-2852-25	10-2853-25			

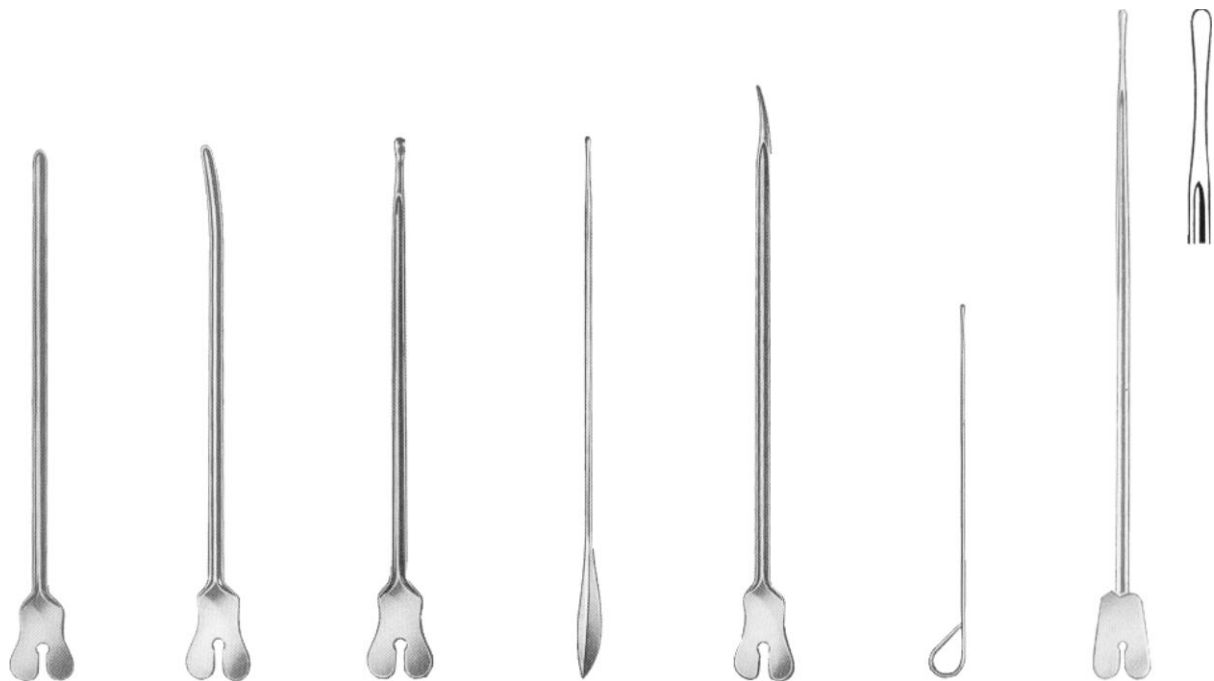

cm	In				Nelaton	Stacke 1.0 mm Ø	Brodie
10.5	4 1/4"					10-2863-10	
11.5	4 1/2"	10-2858-11					
13	5"	10-2858-13		10-2860-13	10-2861-13		
14.5	5 3/4"	10-2858-14	10-2859-14	10-2860-14	10-2861-14		
16	6 1/4"	10-2858-16		10-2860-16	10-2861-16	10-2862-16	10-2864-16
18	7"	10-2858-18		10-2860-18			
20	8"	10-2858-20			10-2861-20		

PROBES, APPLICATORS, SPATULAS

Of tin



10-2865-25 25 cm/10"
 10-2865-30 30 cm/12"
 10-2865-40 40 cm/15¾"

Plaster spatulas



10-2866-13 13 cm/5"
 10-2866-14 14 cm/5½"

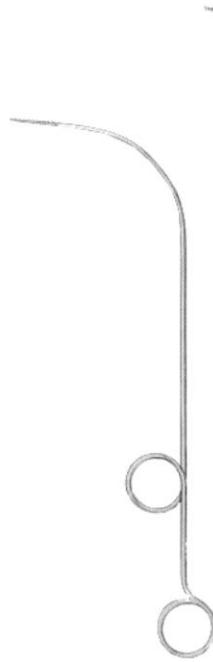

Pelteson
 10-2867-23
 23 cm/9"

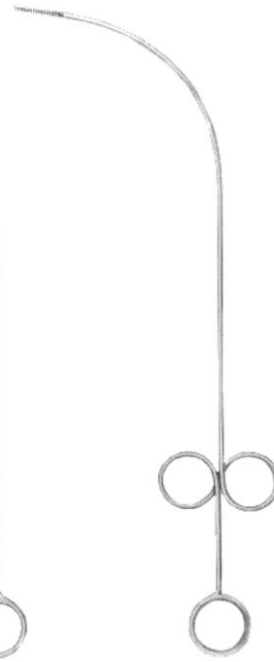

Fein
 10-2868-28
 28 cm/11"



Buie
 10-2869-16
 16 cm/6¼"

Fistula probes



Lockhart-Mummy
 16.5 cm/6½"



Fig. 1
 10-2870-01



Fig. 2
 10-2870-02



Fig. 3
 10-2870-03

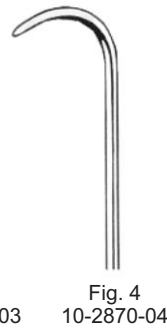

Fig. 4
 10-2870-04



10-2871-01



10-2871-02



Pratt
 21 cm/8¼"



10-2871-03

PROBES, APPLICATORS, SPATULAS



Universal

cm	in	1.2 mm Ø	1.5 mm Ø	1.7 mm Ø
12.5	5"	10-2872-12		
16	6¼"	10-2872-16		
18	7"	10-2872-18	10-2873-18	10-2874-18



Uckermann
10-2875-16
16 cm/6¼"



Jobson-Horne
10-2876-13 13 cm/5"
10-2876-18 18 cm/7"



Round Triangular

Farrell
(Farrell-Lathbury)

cm	in	●	▲
12	4¾"		
14	5½"	0.9 mm Ø	10-2877-14
16	6¼"	1.1 mm Ø	10-2877-16
18	7"		



Round Triangular

●	●	▲
1.2 mm Ø	1.5 mm Ø	1.5 mm Ø
10-2879-12	10-2880-12	10-2881-12
10-2879-14	10-2880-14	10-2881-14
10-2879-16	10-2880-16	10-2881-16
10-2879-18	10-2880-18	10-2881-18

PROBES, APPLICATORS, SPATULAS

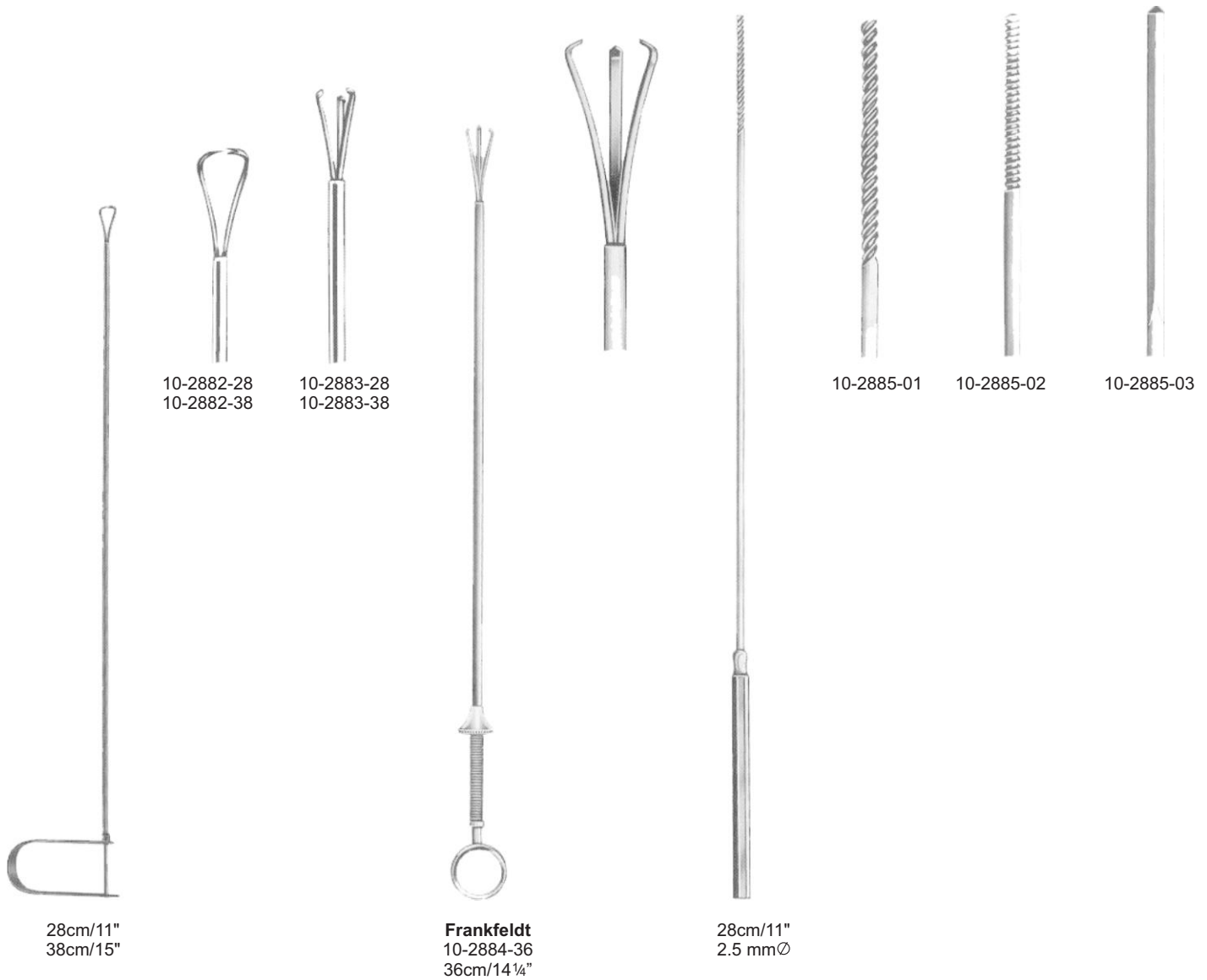

PROBES, APPLICATORS, SPATULAS

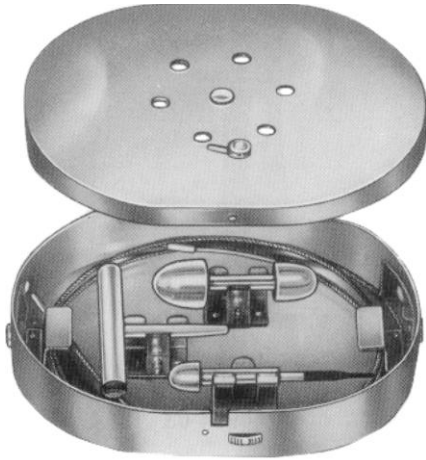

Nabatoff
10-2886-00
135x100x25 mm

Sterilizable

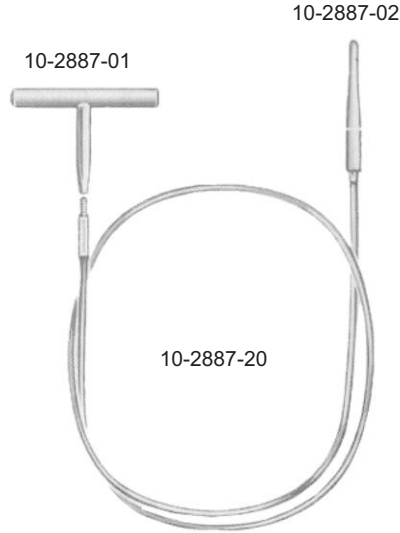

10-2887-01

10-2887-02

10-2887-20

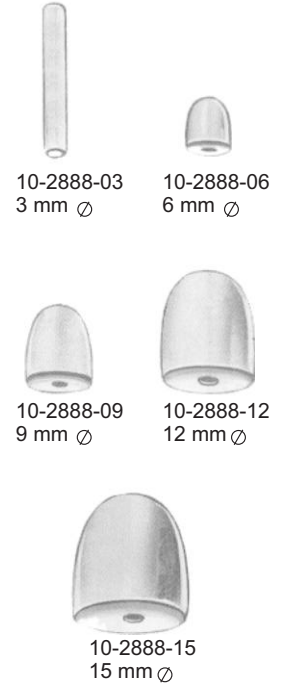

10-2888-03
3 mm Ø

10-2888-06
6 mm Ø

10-2888-09
9 mm Ø

10-2888-12
12 mm Ø

10-2888-15
15 mm Ø

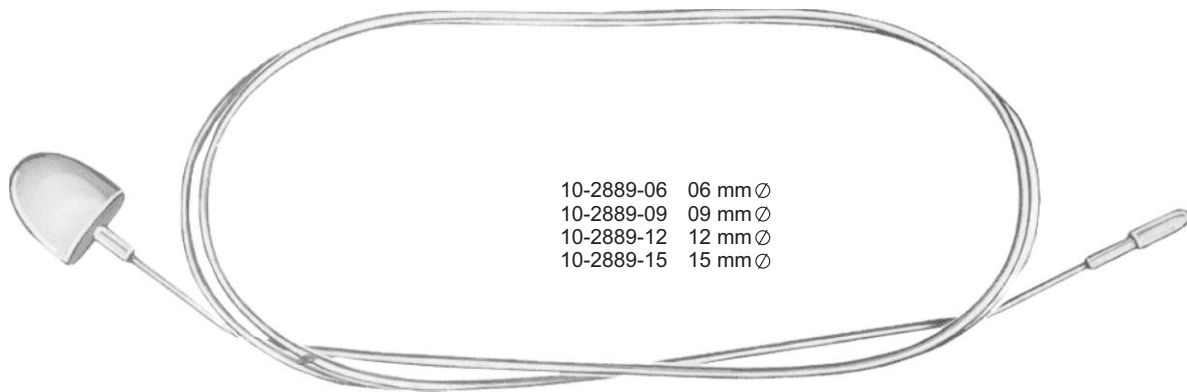

10-2889-06 06 mm Ø
10-2889-09 09 mm Ø
10-2889-12 12 mm Ø
10-2889-15 15 mm Ø

Myers

PROBES, APPLICATORS, SPATULAS

Strippers

	mm Ø
10-2890-02	2.0
10-2890-03	3.0
10-2890-04	4.0
10-2890-06	6.0
10-2890-07	7.0
10-2890-08	8.5
10-2890-10	10.0
10-2890-12	12.0
10-2890-14	14.0



55cm/21½"



Handle for 10-2890-00

Probes for Varicose Veins

Malleable



Babcock

cm	in	
40	13½"	10-2891-40
50	20"	10-2891-50
65	26"	10-2891-65
80	32"	10-2891-80

Vessel Irrigating Cannulas

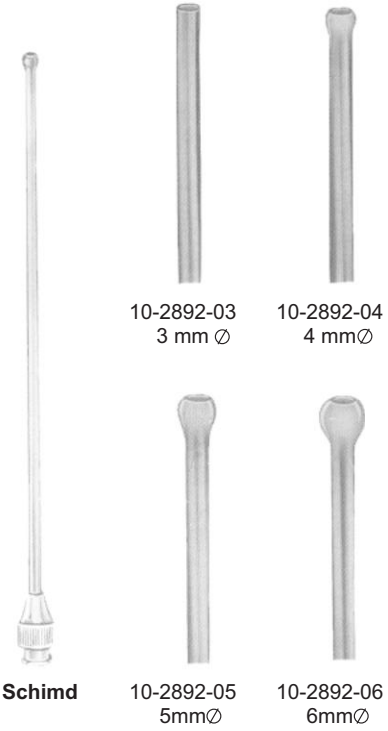

10-2892-03
3 mm Ø

10-2892-04
4 mm Ø

10-2892-05
5mm Ø

10-2892-06
6mm Ø

Spatulas

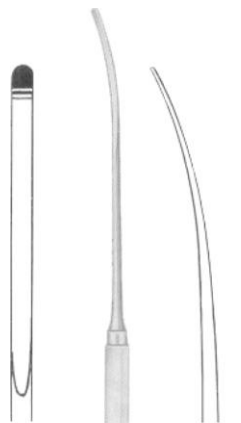

3 mm
Blunt

10-2893-18 18.0 cm/7"
10-2893-21 21.5 cm/8½"



Schmid

10-2894-14
14 cm/5½"
5 mm

10-2894-24
24 cm/9¼"
7 mm

- EN** Retractors
- DE** Wundhaken und -sperrer
- ES** Separadores

Page 182 to 241

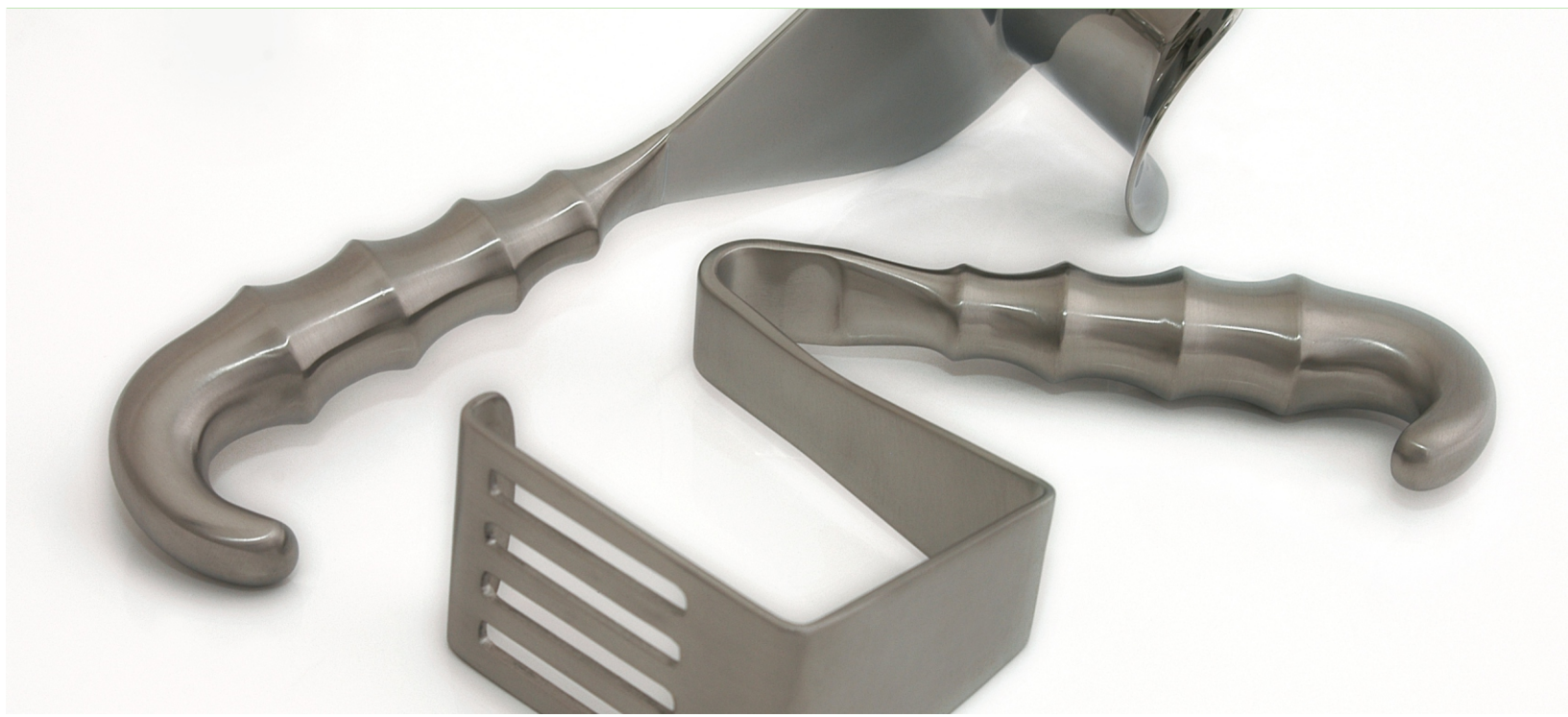

RETRACTORS



RETRACTORS

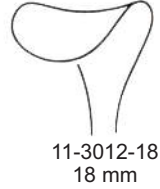
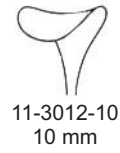

Sharp



Blunt

Graefe
11-3014-16 16cm/6¼"

11-3015-16



11-3016-16
16cm/6¼"



11-3017-16
16cm/6¼"



O, Connor
11-3018-16
16cm/6¼"



Guthrie
11-3019-16 16cm/6¼"



11-3020-16



11-3021-16
16cm/6¼"



11-3022-16
16cm/6¼"

RETRACTORS

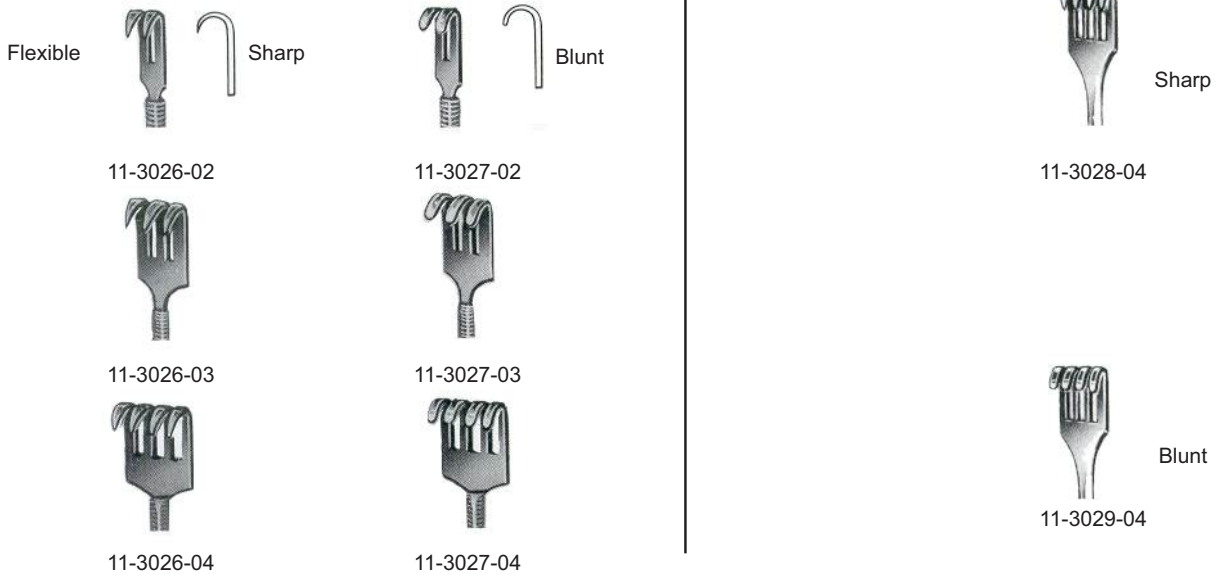

RETRACTORS



RETRACTORS

Malleable



Gil-Vernet
24cm/9½"

08 mm 11-3038-08	11-3039-08
11 mm 11-3038-11	11-3039-11
15 mm 11-3038-15	11-3039-15
17 mm 11-3038-17	11-3039-17
20 mm 11-3038-20	11-3039-20
23 mm 11-3038-23	11-3039-23

Malleable



24cm/9½"

12x14 mm



Little
11-3040-20
20cm/8"



Love-(Morse)
25cm/10"

- 10 mm 11-3041-10
- 15 mm 11-3041-15
- 20 mm 11-3041-20
- 30 mm 11-3041-30
- 40 mm 11-3041-40
- 50 mm 11-3041-50

RETRACTORS

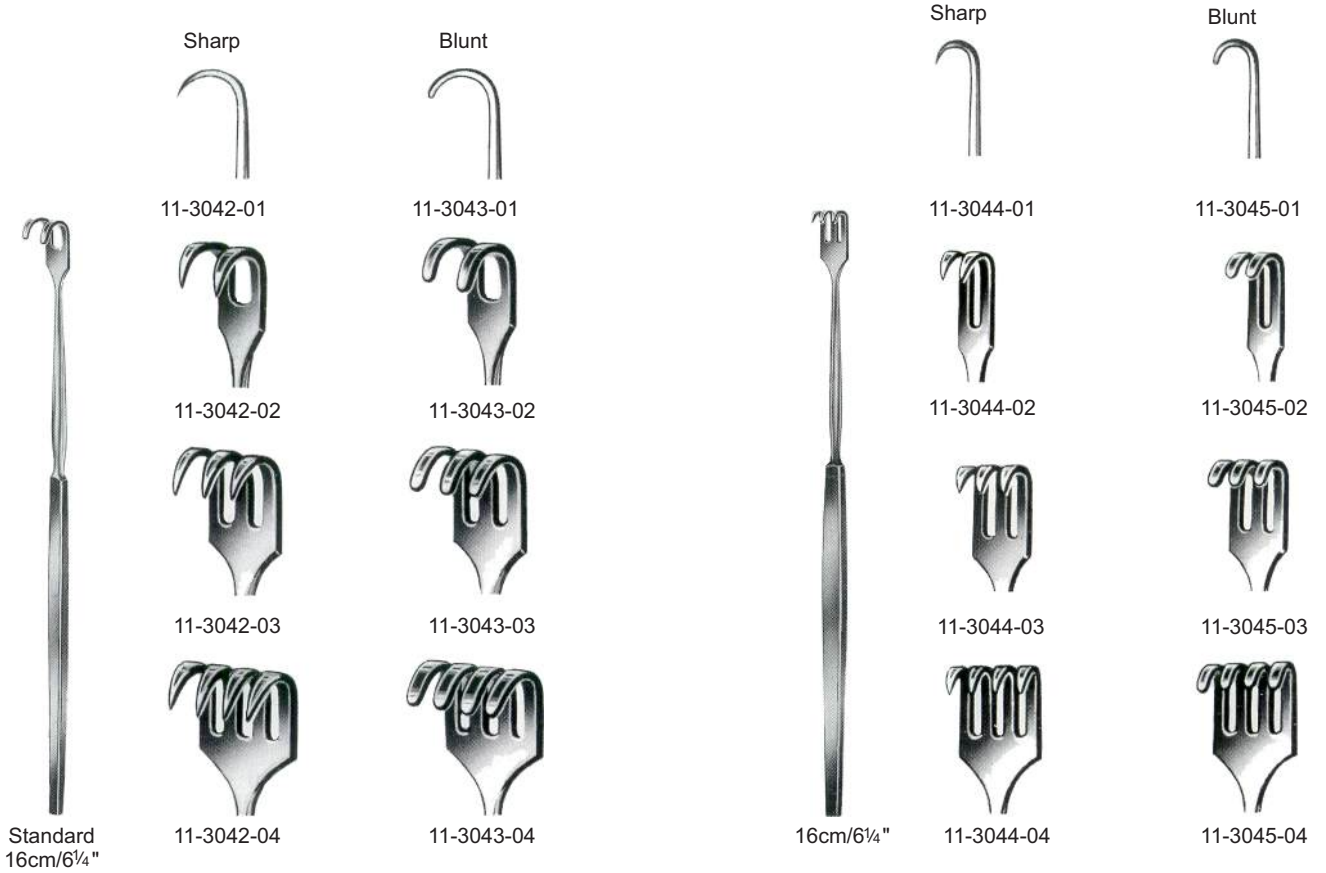

RETRACTORS



11-3050-02
13.5m/5¼"



Jackson
11-3051-13
13cm/5"



Bergmann
11-3052-14
14cm/5½"



Iterson
16cm/6¼"



11-3053-16



11-3054-16



Meyerding
18cm/7"



11-3055-18
18x7 mm



11-3056-18
16x5 mm



11-3055-18
7x4 mm



11-3056-18
10x3 mm



11-3055-18
7x4 mm



11-3056-18



Volkman
11.5cm/4½"



Sharp

11-3057-02



Blunt

11-3058-02



11-3057-03



11-3058-03



11-3057-04



11-3058-04



11-3057-06



11-3058-06

RETRACTORS

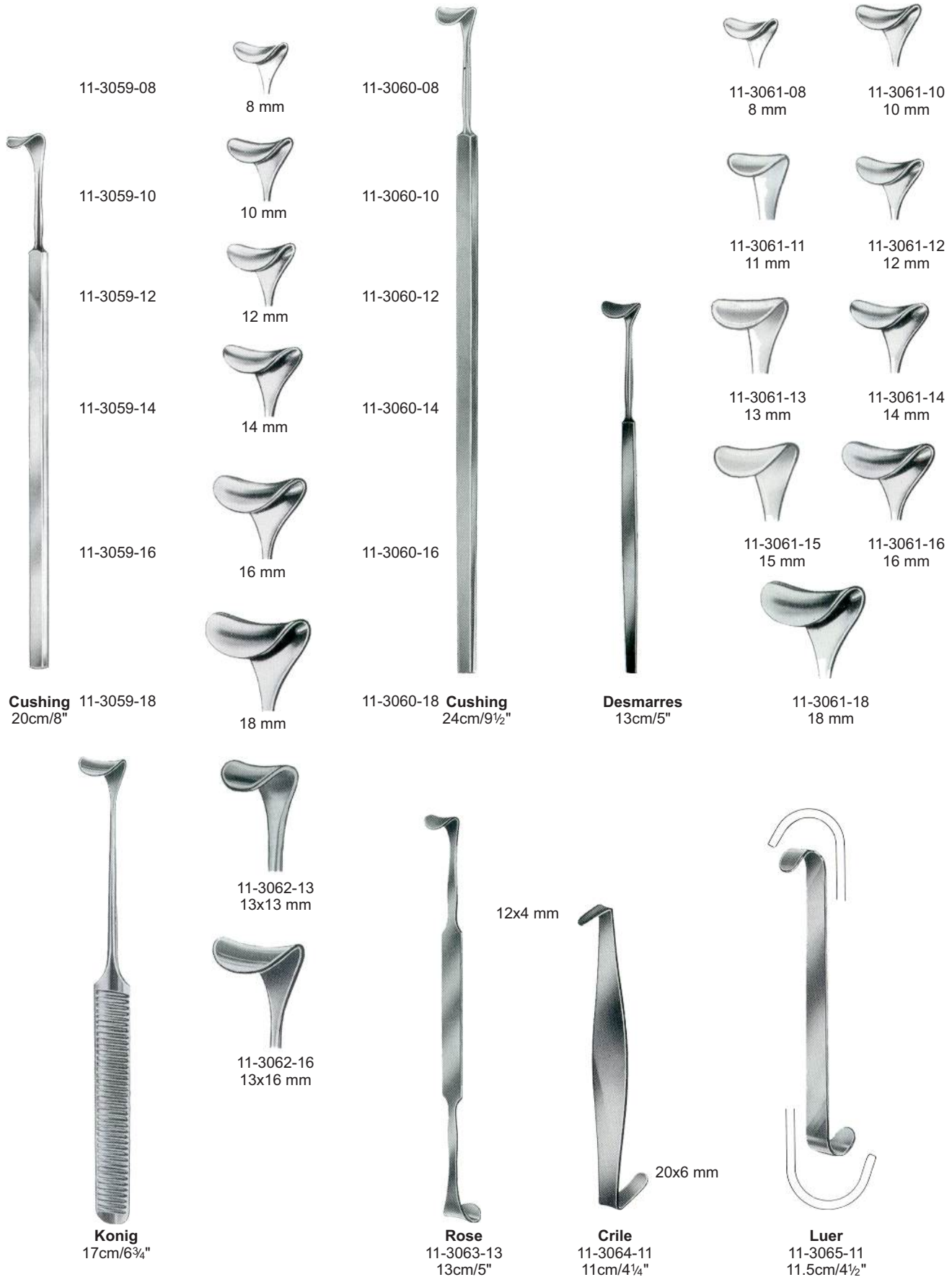

RETRACTORS



Cushing-Kocher
11-3066-18
18cm/7"

10x10 mm



Langenbeck-Green
17cm/6¾"



11-3067-17
6x25 mm

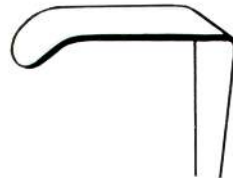

11-3068-17
8x25 mm



Strandell-Stille
19cm/7½"



11-3069-19



11-3070-19

toothed

Tendon Sheath Hook



11-3071-02



11-3071-03



Klapp
17.5 cm/7"



11-3071-04

Decompression Hook



Cushing
11-3072-20
20cm/8"

RETRACTORS



Senn-Miller
16cm/6¼"

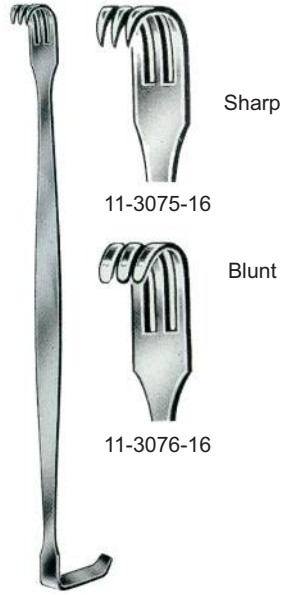

Baby-Senn-Miller
16cm/6¼"



Rangell-Davis
11-3077-14
14cm/5½"



Senn-Green
15cm/6"



Langenbeck-Green
16cm/6¼"

RETRACTORS



Collin-Hartmann

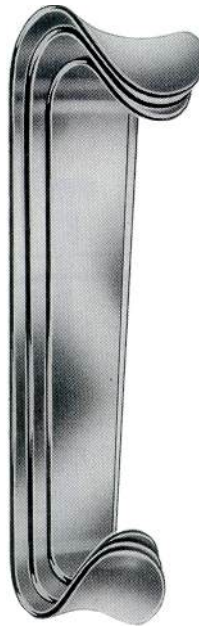

Roux



Baby-Roux
13 cm/5"



Mini-Roux
14 cm/5½"

Set	11-3084-00	Set	11-3085-00	11-3086-13	11-3087-14
14 cm/5½"	11-3084-01	14 cm/5½" Fig. 1	11-3085-01		
16 cm/6"	11-3084-02	15 cm/6" Fig. 2	11-3085-02		
		17 cm/6¾" Fig. 3	11-3085-03		

37x40 mm



37x31 mm

Goelet
11-3088-19
19 cm/7½"



Parker-Langenbeck (US-Army)
11-3089-21
21cm/8¼"

Set



Parker
11-3090-13
13.5 cm/5¼"

Set



Parker
11-3091-18
18 cm/7"

Set

RETRACTORS



Set

Parker-Mott
 11-3092-16
 16 cm/6¼"



Set

Farabeuf
 11-3093-12
 12 cm/4¾"



Set

Farabeuf
 11-3094-15
 15 cm/6"



Set

Collin
 11-3095-16
 16.5 cm/6½"



Set

Mayo-Collin
 11-3096-15
 15 cm/6"



Set

Mathieu
 11-3097-19
 19 cm/7½"

RETRACTORS

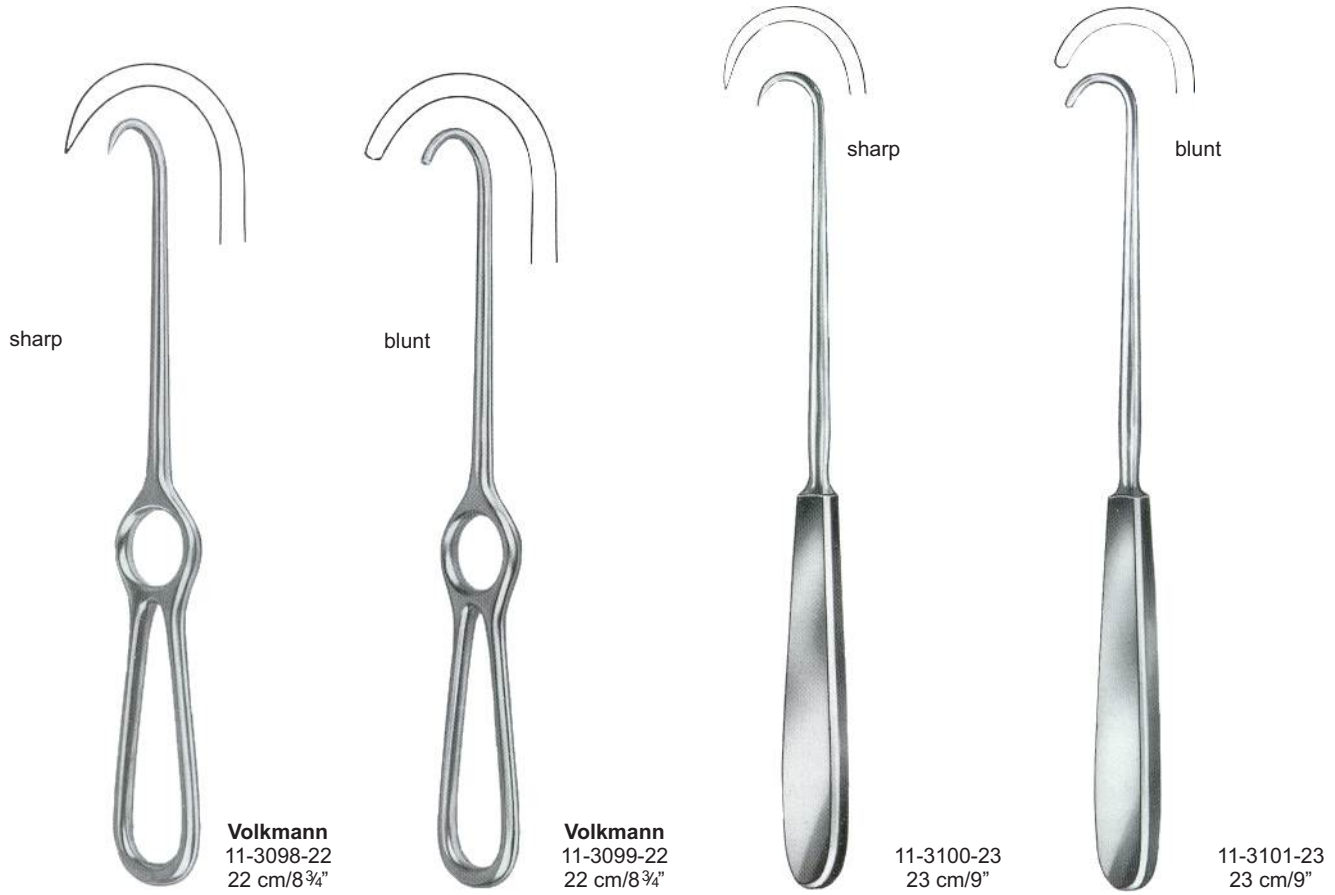

RETRACTORS



Volkmann
23 cm/9"

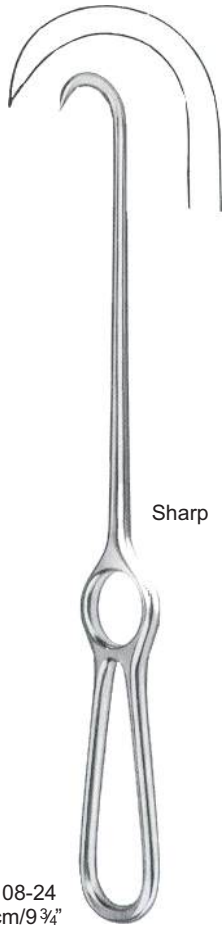
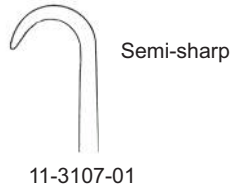

RETRACTORS



Kocher
21.5cm/8½"

		15x10 mm	15x15 mm	15x20 mm	15x30 mm	15x40 mm
sharp						
	11-3113-01	11-3113-02	11-3113-03	11-3113-04	11-3113-06	11-3113-08
blunt						
	11-3114-01	11-3114-02	11-3114-03	11-3114-04	11-3114-06	11-3114-08
semi-sharp						
	11-3115-01	11-3115-02	11-3115-03	11-3115-04	11-3115-06	11-3115-08

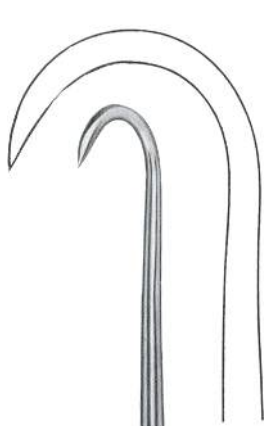

sharp

11-3116-20
20 cm/8"



blunt

11-3117-20
20 cm/8"



sharp

11-3118-14
14 cm/5½"

RETRACTORS



11-3119-03
36x30 mm



11-3120-04
36x60 mm

Ollier
22.5 cm/9"



Murphy
19.5 cm/7¾"

Sharp



11-31121-02



11-3121-03



11-3121-04



11-3121-06

blunt



11-3122-02



11-3122-03



11-3122-04



11-3122-06

RETRACTORS



Wassmund
11-3123-20
20cm/8"



11-3124-02
40x50 mm

Israel
25cm/10"



11-3124-01
40x40 mm



11-3124-03
50x60 mm



11-3124-04
70x70 mm

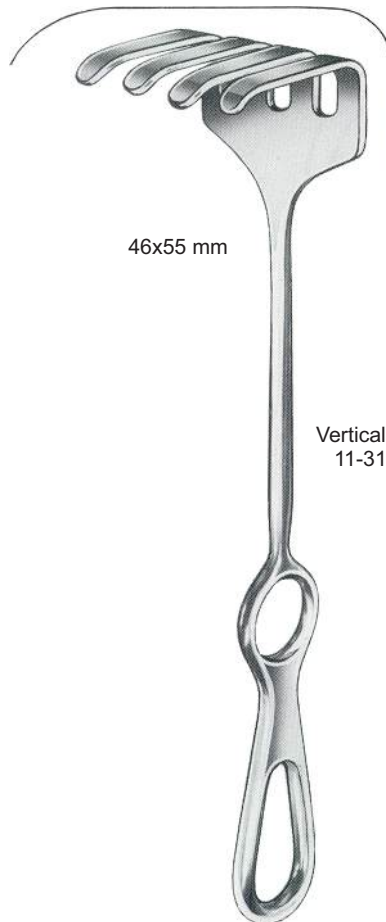

46x55 mm

Vertical Handle
11-3125-23

Koerte
23cm/9"

RETRACTORS



RETRACTORS



85x15 mm

Vertical Handle

Langenbeck
11-3131-21
21.5cm/8½"



11-3132-01
55x20 mm
11-3132-02
63x20 mm
11-3132-03
60x20 mm

Langenbeck
21cm/8¼"



11-3133-01
35x7 mm
11-3133-02
35x10 mm
11-3133-03
35x15 mm
11-3133-04
60x20 mm

Langenbeck
21cm/8¼"



11-3134-19
28x6 mm

Lahey
19cm/7½"



23cm/9"

Sauerbruch
11-3135-01 45x15 mm
11-3135-02 55x23 mm
11-3135-03 72x20 mm



Langenbeck
21cm/8¼"

11-3136-01 30x11 mm 11-3137-01
11-3136-03 33x14 mm
11-3136-04 30x16 mm
11-3136-05 40x11 mm 11-3137-05
11-3136-06 42x13 mm 11-3137-06
11-3136-07 50x11 mm



Langenbeck
22cm/8¾"

RETRACTORS



38x20 mm

Kocher
 11-3138-22
 22cm/8¾"



11-3139-01
 19x12 mm
 11-3139-02
 21x15 mm

Kocher
 19cm/7½"

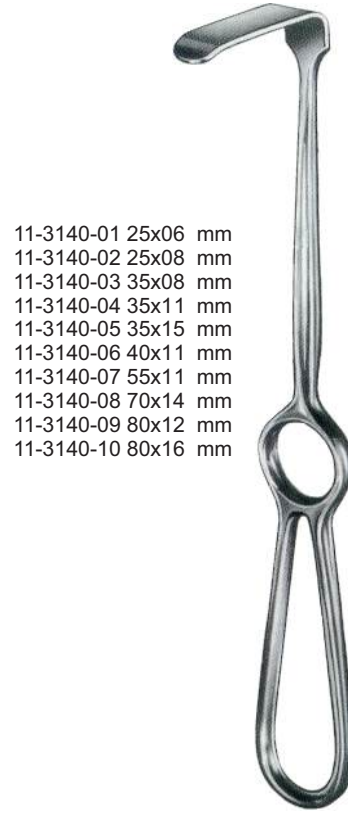

11-3140-01 25x06 mm
 11-3140-02 25x08 mm
 11-3140-03 35x08 mm
 11-3140-04 35x11 mm
 11-3140-05 35x15 mm
 11-3140-06 40x11 mm
 11-3140-07 55x11 mm
 11-3140-08 70x14 mm
 11-3140-09 80x12 mm
 11-3140-10 80x16 mm

Kocher-Langenbeck
 21.5cm/8½"



67x17cm

Casper
 11-3141-21
 21.5cm/8½"

RETRACTORS

11-3143-01
22x15 mm

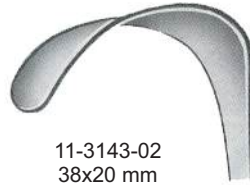

11-3143-02
38x20 mm



11-3143-03
67x25 mm



11-3143-04
100x35 mm

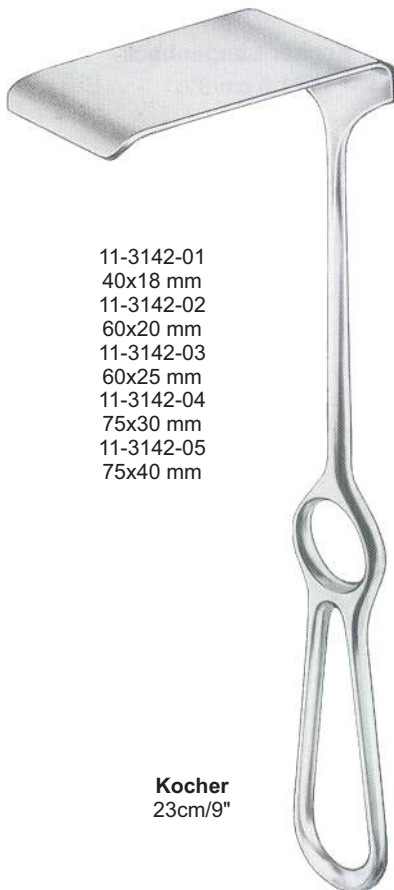

11-3142-01
40x18 mm
11-3142-02
60x20 mm
11-3142-03
60x25 mm
11-3142-04
75x30 mm
11-3142-05
75x40 mm

Kocher
23cm/9"

Kocher-Wagner
28cm/11"



11-3144-01
60x20 mm
11-3144-02
80x30 mm
11-3144-03
100x30 mm
11-3144-04
120x30 mm
11-3144-05
140x30 mm
11-3144-06
140x40 mm

Heesel
25cm/10"

RETRACTORS



130x60 mm

St. Marks
 11-3145-29
 29cm/11½"

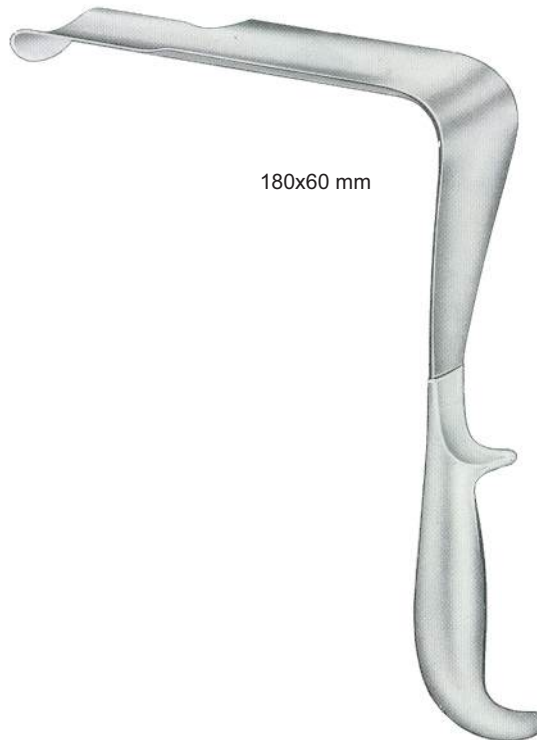

180x60 mm

St. Marks
 11-3146-32
 32.5cm/12¾"

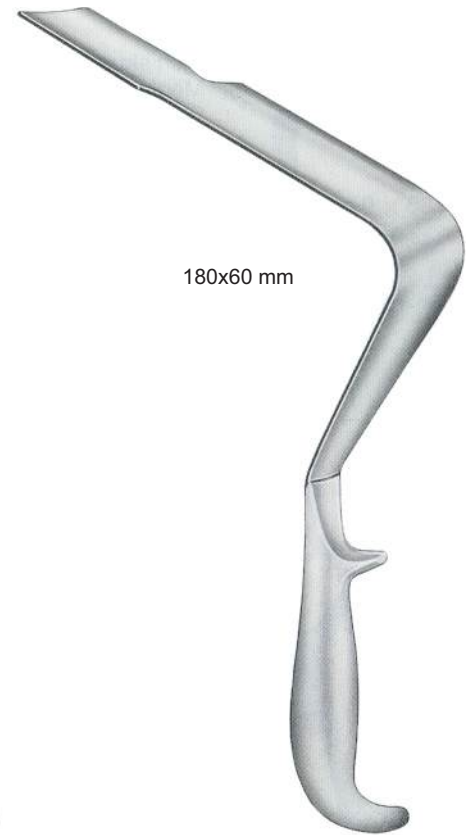

180x60 mm

St. Marks
 11-3147-33
 33cm/13"

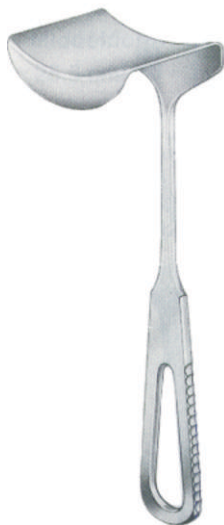

Morris
 21cm/8¼"

11-3148-01
 70x40 mm
 11-3148-02
 70x50 mm
 11-3148-03
 70x65 mm



Morris
 24cm/9½"

11-3149-01
 32x50 mm/38x50mm
 11-3149-02
 45x50 mm/50x50mm
 11-3149-03
 65x50 mm/38x50mm

RETRACTORS

Meniscus Retractors

38x9 mm



11-3150-21
21cm/8¼"

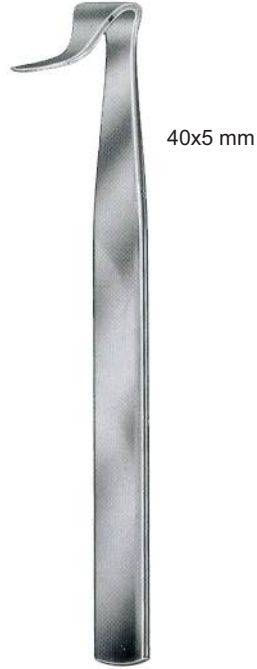

Blount
11-3151-18
18cm/7"



Crawford
19cm/7½"

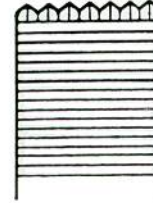

11-3152-01
15x15 mm

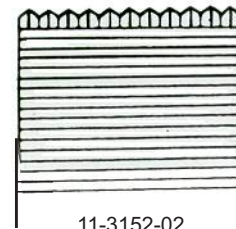

11-3152-02
15x23 mm



Green
11-3152-22
22cm/8½"



Middeldorpf

11-3153-01



14x17 mm
21.5cm/8½"

11-3153-02



22x22 mm
22cm/8¾"

11-3153-03



26x30 mm
23.5cm/9¼"

11-3154-01



Middeldorpf

11-3154-02

11-3154-03

RETRACTORS



11-3155-01
45x45 mm

Middeldorpf
25.5cm/10"

- 11-3155-01
45x45 mm
- 11-3155-02
45x50 mm
- 11-3155-03
55x70 mm



Richardson
26cm/10 1/4"



11-3156-01
28x20 mm

11-3156-02
30x28 mm

11-3156-03
38x37 mm

11-3156-04
52x22 mm

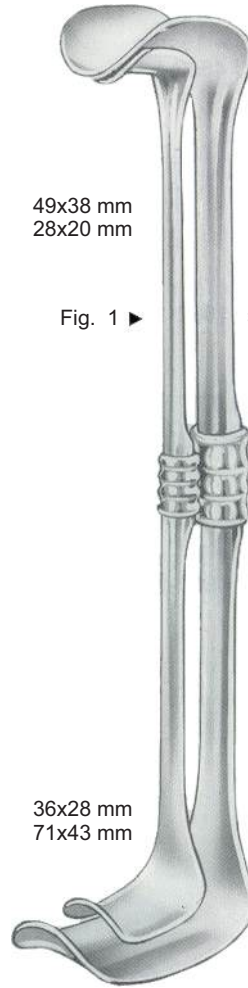

49x38 mm
28x20 mm

Fig. 1 ▶

◀ Fig. 2

36x28 mm
71x43 mm

Richardson-Eastman

Set 11-3157-00

Fig. 1
26cm/10 1/4" 11-3157-01

Fig. 2
28cm/11" 11-3157-02



Kelly
26cm/10 1/4"

- 11-3158-01
40x50 mm
- 11-3158-02
50x65 mm
- 11-3158-03
65x75 mm
- 11-3158-04
75x90 mm

RETRACTORS

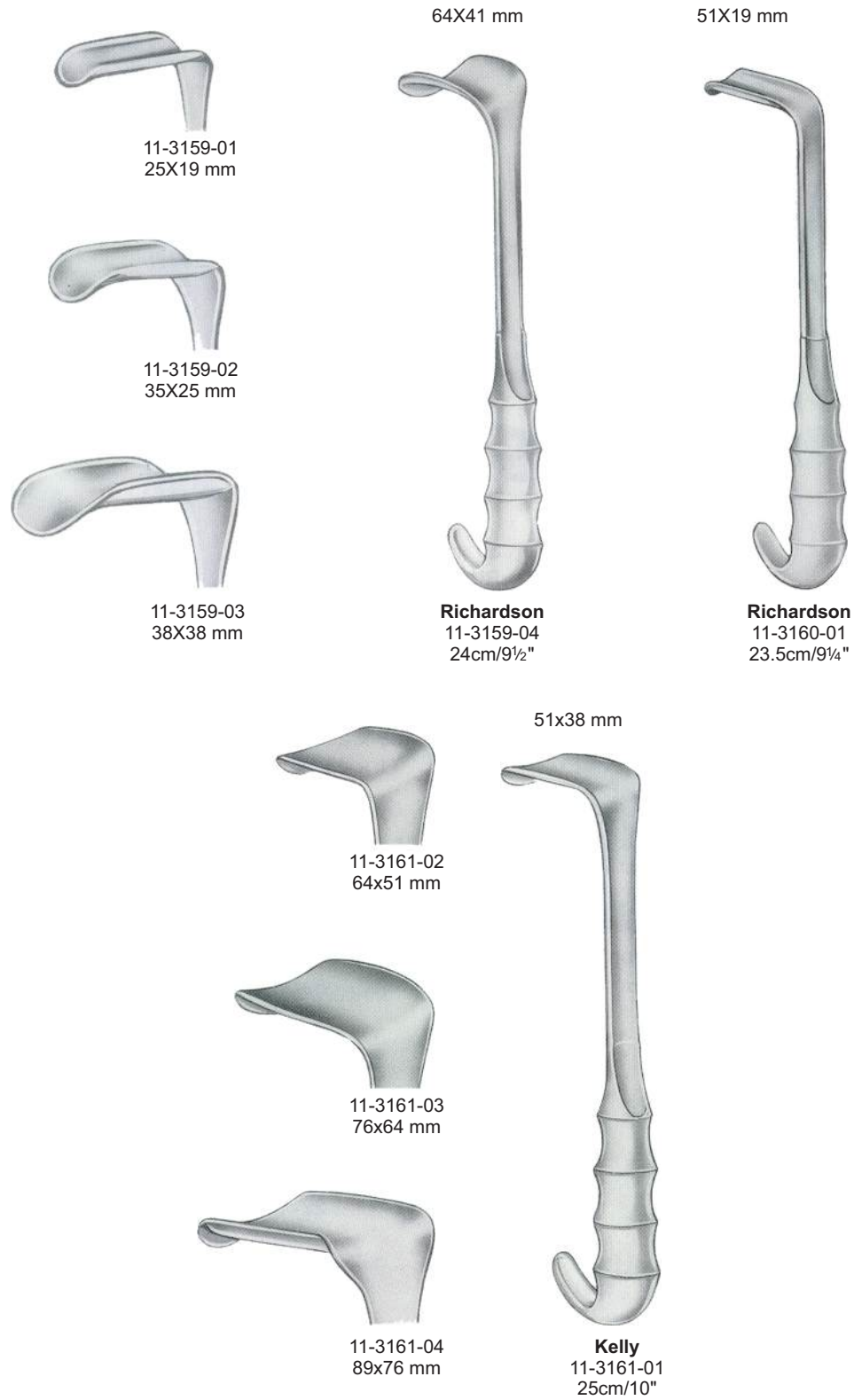

RETRACTORS

11-3162-01
45x40 mm
 11-3162-02
45x50 mm
 11-3162-03
45x60 mm
 11-3162-04
45x75 mm
 11-3162-05
65x85 mm



Fritsch
24cm/9½"

50x85 mm

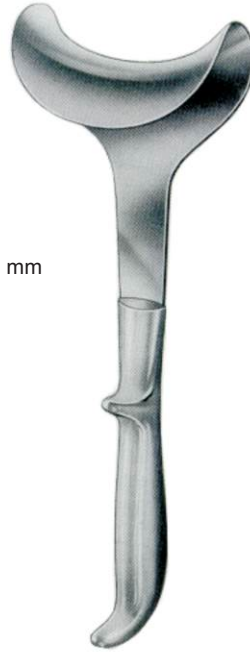

Doyen
11-3163-25
25cm/10"

11-3164-01
15x90 mm
 11-3164-02
20x90 mm
 11-3164-03
30x90 mm
 11-3164-04
35x110 mm
 11-3164-05
40x110 mm
 11-3164-06
55x120 mm

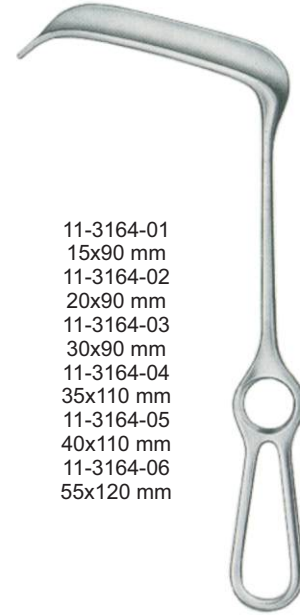

Doyen-Stillé
24cm/9½"

70x25 mm



Kocher
11-3165-22
22.5cm/9"

11-3166-01
80x42 mm
 11-3166-02
80x50 mm
 11-3166-03
80x60 mm



Kocher
25cm/10"

60x60 mm



Tuffier
11-3167-23
23cm/9"

11-3168-01
115x22 mm



Simon
28cm/11"

RETRACTORS

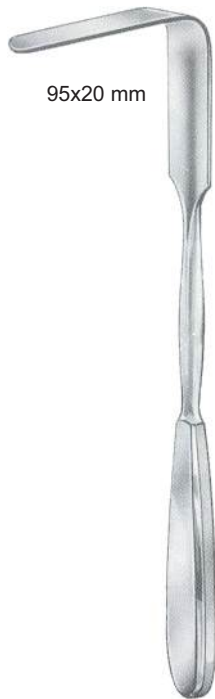

95x20 mm

Tuebingen
11-3169-28
28cm/11"



105x27 mm

Martin
11-3170-26
26cm/10¼"

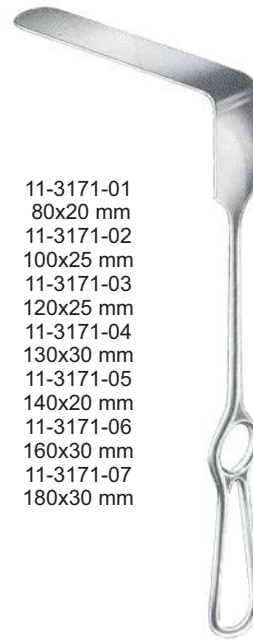

- 11-3171-01
80x20 mm
- 11-3171-02
100x25 mm
- 11-3171-03
120x25 mm
- 11-3171-04
130x30 mm
- 11-3171-05
140x20 mm
- 11-3171-06
160x30 mm
- 11-3171-07
180x30 mm

Brunner
25cm/10"

RETRACTORS

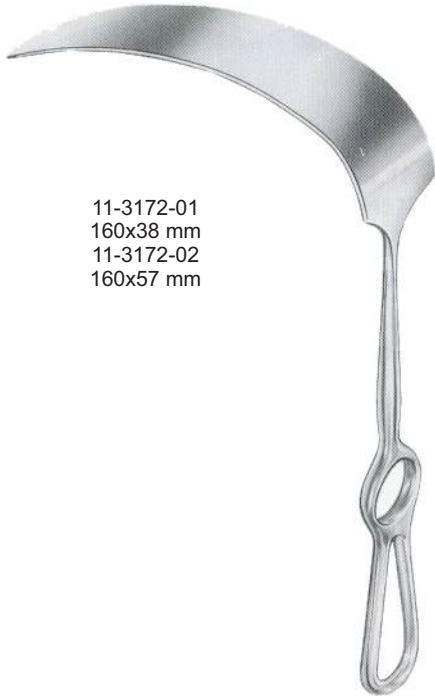

11-3172-01
 160x38 mm
 11-3172-02
 160x57 mm

Kelly
 27cm/10½"



Polloson
 11-3173-27
 27cm/10½"



Polloson
 11-3174-27
 27cm/10½"



11-3175-03
 115x65 mm

11-3175-02
 115x38 mm

11-3175-01
 82x20 mm

Coryllos
 23.0cm/9"

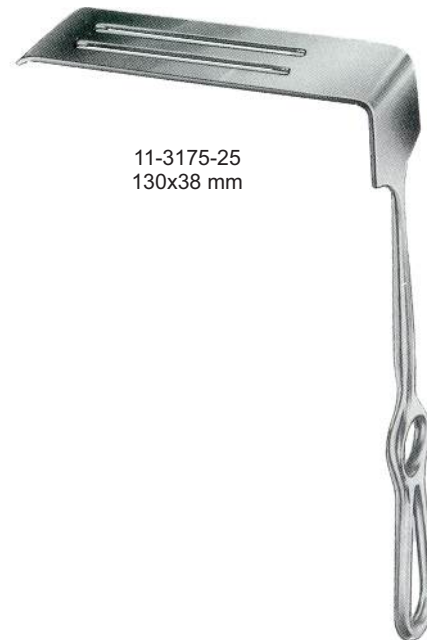

11-3175-25
 130x38 mm

Sauerbruch
 25cm/10"

RETRACTORS

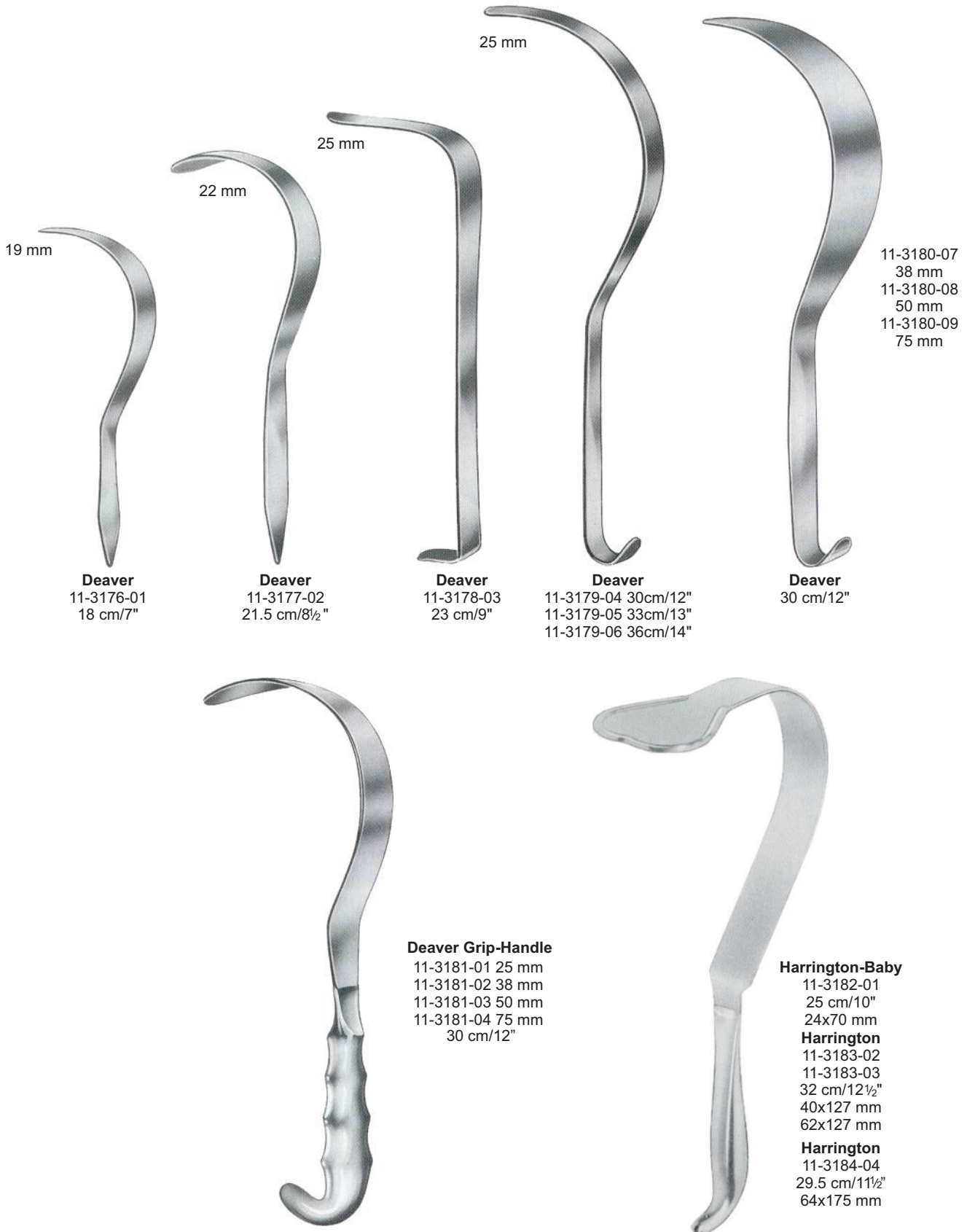

RETRACTORS



11-3185-01
 50x16 mm
 11-3185-02
 75x25 mm
 11-3185-03
 90x50 mm

Meyerding
 22.5cm/9"



Zenker

11-3186-01 25cm/10" 35x08 mm
 11-3186-02 26cm10¼" 60x12 mm
 11-3186-03 27.5cm/10¾" 75x12 mm

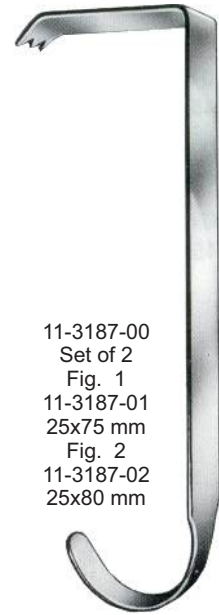

11-3187-00
 Set of 2
 Fig. 1
 11-3187-01
 25x75 mm
 Fig. 2
 11-3187-02
 25x80 mm

Hibbs
 24cm/9½"

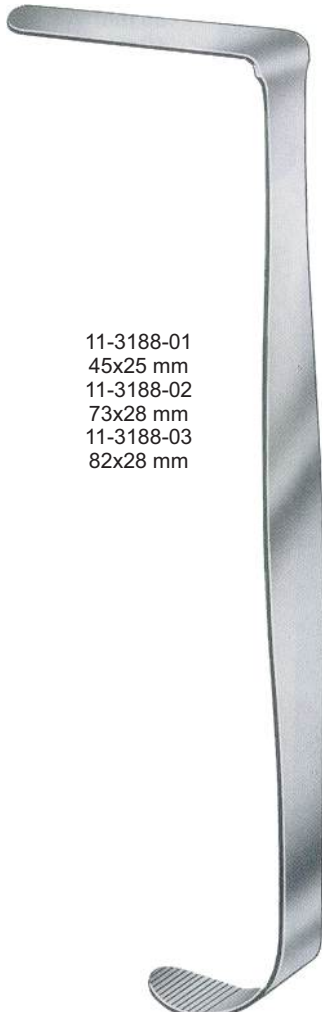

11-3188-01
 45x25 mm
 11-3188-02
 73x28 mm
 11-3188-03
 82x28 mm

Heaney
 27cm/10½"

46 mm



Kuemmel
 11-3189-33
 33cm/13"

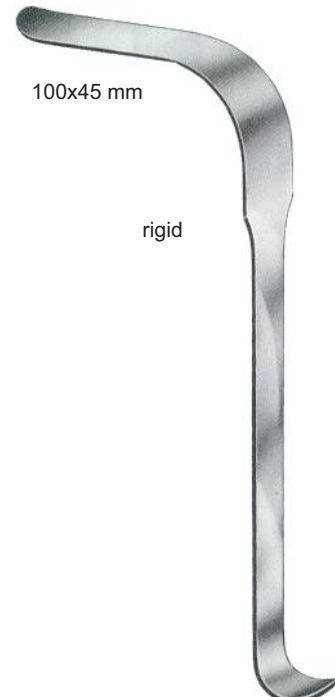

100x45 mm

rigid

Koerte
 11-3190-28
 28cm/11"

RETRACTORS

11-3191-20
20 mm
11-3191-30
30mm
11-3191-40
40 mm



Kader
27cm/10 1/2"



11-3192-01
25.5cm/10"
45 mm
11-3192-02
27.5cm/10 3/4"
60 mm

Leriche



Malleable
11-3193-01 20 mm
11-3193-02 25 mm
11-3193-03 30 mm
11-3193-04 35 mm
11-3193-05 40 mm
11-3193-06 45 mm
11-3193-07 50 mm
11-3193-08 64 mm
11-3193-09 76 mm
11-3193-10 102 mm
33cm/13"

Malleable



Tuffier
11-3194-20
20 cm/8"
17x25 mm

Malleable

11-3195-01
200x6 mm
11-3195-02
200x8 mm
11-3195-03
200x10 mm
11-3195-04
200x12 mm
11-3195-05
200x17 mm
11-3195-06
200x20 mm
11-3195-07
200x25 mm
11-3195-08
250x25 mm



20cm/8"

Malleable

11-3196-01
280x25/30 mm
11-3196-02
300x37/45 mm
11-3196-03
300x40/50 mm



Haberer
21cm/8 1/4"



Reverdin
11-3197-28
28 cm/11"

RETRACTORS



Davidson
 16cm/6¼"
 75x50 mm 11-3198-01
 75x90 mm 11-3198-02



Cooley
 11-3199-01
 21.5cm/8½"

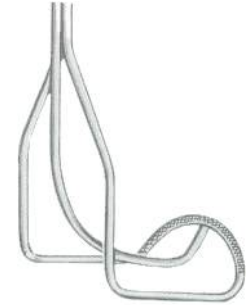

Cooley
 11-3199-02
 21.5cm/8½"



Cooley
 11-3199-03
 23cm/9"



Ross
 27cm/10½"

- Fig. 1 11-3200-01 13x13 mm
- Fig. 2 11-3200-02 14x12 mm
- Fig. 3 11-3200-03 18x18 mm
- Fig. 4 11-3200-04 20x20 mm
- Fig. 5 11-3200-05 22x18 mm
- Fig. 6 11-3200-06 26x24 mm

RETRACTORS

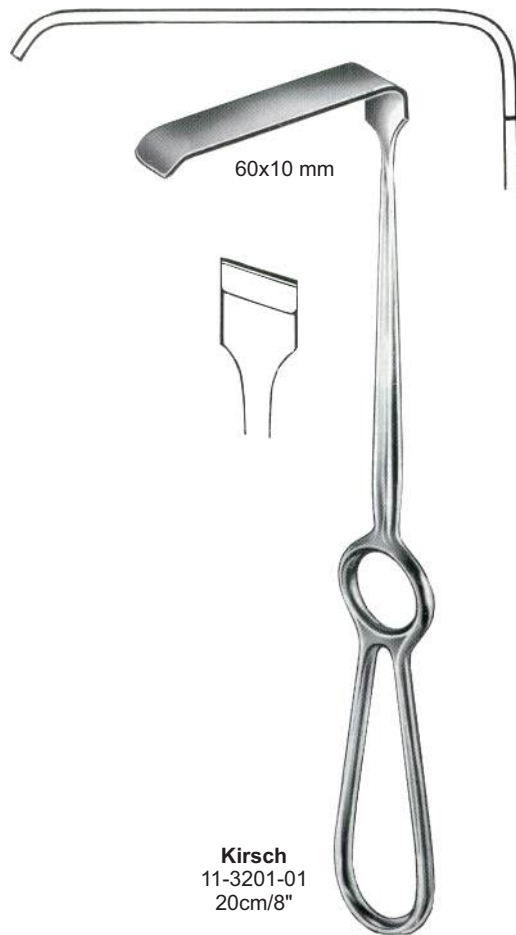

RETRACTORS



22cm/8¾"



11-3205-01
 25x7 mm



11-3205-02
 31x10 mm



11-3205-03
 42x11 mm



11-3205-04
 55x12 mm



11-3205-05
 70x14 mm



11-3205-06
 80x18 mm

RETRACTORS



22cm/8¾"



11-3206-01
42x13 mm



11-3206-02
60x12 mm



11-3206-03
80x16 mm

RETRACTORS



Spina-Nasalis
 11-3207-01
 22 cm/8¾"

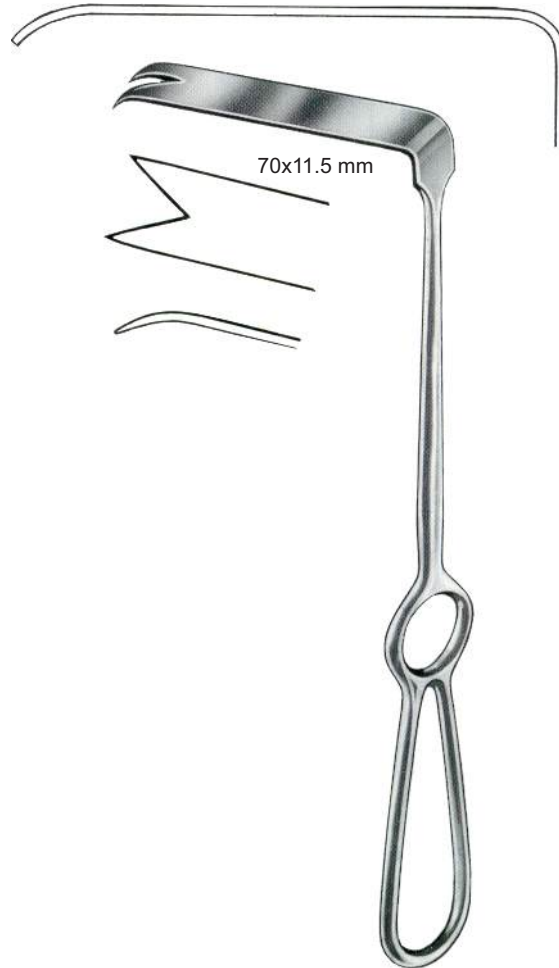

Ramus
 11-3208-02
 22 cm/8¾"



11-3209-15
 15.5 cm/6"



11-3210-16
 16 cm/6¼"

RETRACTORS



11-3211-10 10 mm
11-3211-20 20 mm
19cm/7½"



Dingman
11-3212-17
17.5cm/7"



Soeresen-Hein
11-3213-17
17.5cm/7"



Dingman
11-3214-21
21cm/8¼"



11-3215-18
18.5cm/7¼"

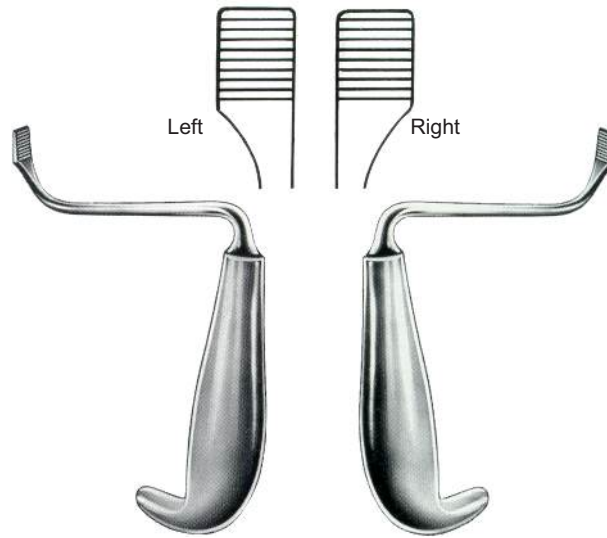

Tessier
11-3216-01
15cm/6"

Tessier
11-3217-02
15cm/6"



Dingman
11-3218-00

RETRACTORS



11-3219-21
21cm/8¼"



11-3220-20
20.5cm/8"

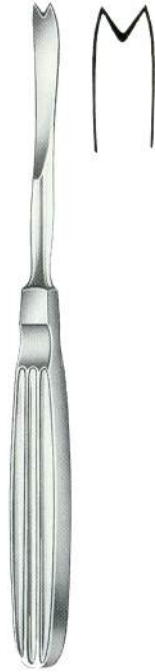

11-3221-17
17.5cm/7"

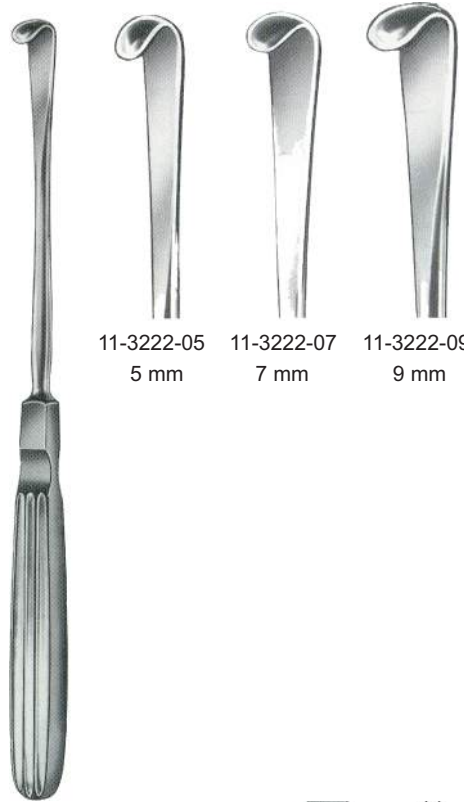

11-3222-05 5 mm
 11-3222-07 7 mm
 11-3222-09 9 mm

20cm/8"



17.5cm/7"



11-3223-06
6 mm



11-3223-07
7 mm



11-3223-09
9 mm



11-3223-11
11 mm

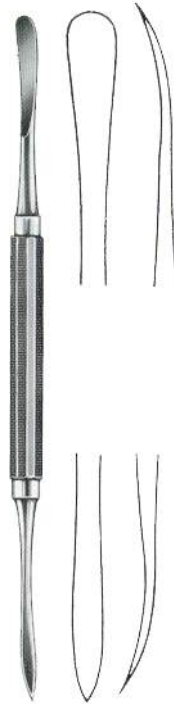

Dingman
 11-3224-18
 18cm/7"



11-3225-23
 23.5cm/9¼"
 10 mm

RETRACTORS



Tessier
20.5cm/8"



11-3226-10
10 mm



11-3227-10
10 mm



11-3228-01
18.5cm/7¼"



11-3229-02
18.5cm/7¼"



11-3230-07
7 mm
21.5cm/8½"



11-3231-10
10 mm
21.5cm/8½"



15cm/6"



11-3232-02
2.5 mm



11-3232-04
4 mm



Bowdler-Henry's
11-3233-16
16.5cm/6½"



Gillies
11-3234-21
21cm/8¼"



Gillies
11-3235-21
21cm/8¼"

RETRACTORS



Sanders-Brown
 11-3236-30
 30cm/12"



Sanders-Brown
 11-3237-29
 29cm/11½"



11-3238-14
 14cm/5½"



11-3239-23
 23cm/9"



11-3240-18
 18cm/7"



Kelsey-Fry
 11-3241-15
 15cm/6"



Kelsey-Fry
 11-3242-18
 18cm/7"



Merston
 11-3243-14
 14.5cm/5½"

RETRACTORS



Bosc



Finsen



Finsen

Sharp

Blunt

Sharp

cm	in				
5	2		11-3245-05	11-3246-05	
7	2¾"	11-3244-07	11-3245-07	11-3246-07	11-3247-07



Allport
11-3248-09
9.5cm/3¾"

Sharp



Alm

Blunt

cm	in		cm	in		
8.5	3 ½"	11-3248-08	7	2¾"	11-3249-07	11-3250-07
11.5	4 ½"	11-3248-11	10	4	11-3249-10	11-3250-10

RETRACTORS



Holzheimer
 Sharp 11-3251-10 10 cm/4"
 blunt 11-3252-10



Jansen
 Sharp 11-3253-10 10.5 cm/4¼"
 blunt 11-3254-10



Jansen-Deep
 Sharp 11-3255-10 10.5 cm/4¼"
 blunt 11-3256-10



Plester
 11-3257-11
 11.5 cm/4½"



Plester
 11-3258-11
 11.5 cm/4½"



Plester
 Sharp 11-3259-13 13 cm/5"
 blunt 11-3260-13

RETRACTORS

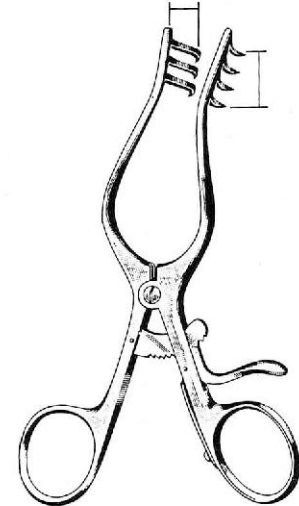
Weitlaner
Weitlaner
Weitlaner-Wullstein

	Sharp	Blunt	Sharp	Blunt	Sharp	Blunt
10.5 cm/4¼"	11-3261-10	11-3262-10				
13.0 cm/5"	11-3261-13	11-3262-13	11-3263-13	11-3264-13	11-3265-13	11-3266-13
14.0 cm/5½"	11-3261-14	11-3262-14	11-3263-14	11-3264-14	11-3265-14	11-3266-14
16.5 cm/6½"	11-3261-16	11-3262-16	11-3263-16	11-3264-16	11-3265-16	11-3266-16

Mollison
 11-3267-15
 15 cm/6"

Tuebinger-Modell
 11-3268-16
 16 cm/6¼"

Complete with 2 pairs of blades and centre blade

Henner(Lempert)
 11-3269-12
 12 cm/4½"

RETRACTORS

Complete with 3 Central blades



Henley
 Sharp 11-3270-16
 16.5 cm/6½"
 Blunt 11-3271-16

Central blades, only



11-3272-19 16x19 mm
 11-3272-25 16x25 mm
 11-3272-32 16x32 mm



Weitlaner-Baby
 13 cm/5"
 11-3273-13
 16 cm/6¼"



Milligan
 Sharp 11-3274-13
 Blunt 11-3275-13



Cone (Adson-Baby)
 Sharp 11-3276-13
 11-3276-16
 Blunt 11-3277-13
 11-3277-16

RETRACTORS



Weitlaner



3x4 Teeth



5x6 Teeth

	Sharp	Blunt	Sharp	Blunt
20 cm/8"	11-3278-20	11-3279-20		
25 cm/10"	11-3278-25	11-3279-25	11-3280-25	11-3281-25



Adson



Anderson-Adson



Cone

	Sharp	Blunt	Sharp	Blunt	Sharp	Blunt
20 cm/8"	11-3282-20	11-3283-20	11-3284-20	11-3285-20	11-3286-20	11-3287-20
26 cm/10¼"	11-3282-26	11-3283-26			11-3286-26	11-3287-26

RETRACTORS

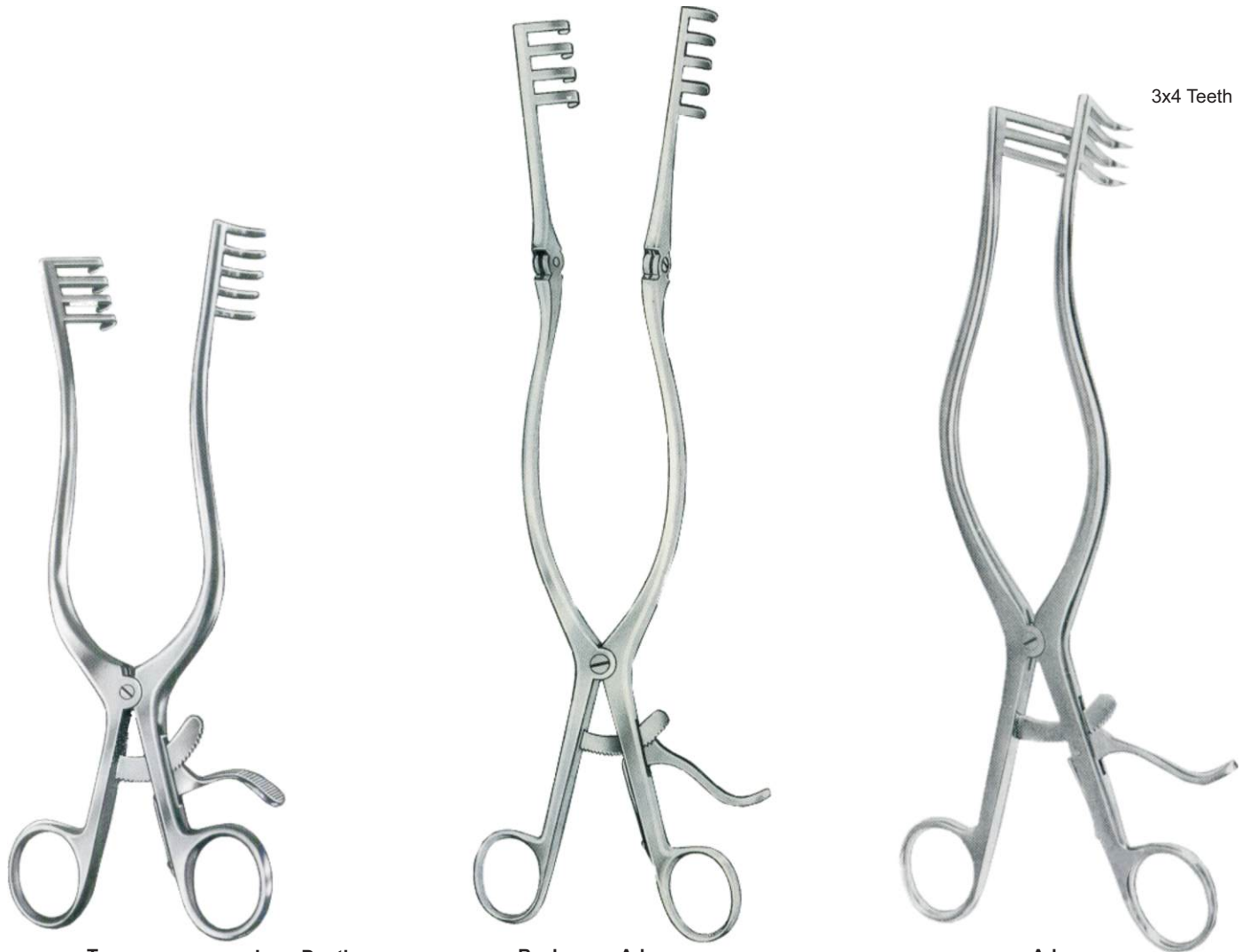

3x4 Teeth

Travers
 11-3288-21
 21 cm/8¼"

Jaws Depth

25 mm
 44 mm

Beckmann-Adson
 31 cm/12¼"

Sharp	Blunt
11-3289-01	11-3290-01
11-3289-02	11-3290-02

Adson
 27 cm/10½"

Sharp	Blunt
11-3291-27	11-3292-27

RETRACTORS

5x6 Teeth



Adson
Sharp 11-3293-27 27cm/10½"
Blunt 11-3294-27



Beckmann-Adson (Standard)
Sharp 11-3295-31 31cm/12¼"
Blunt 11-3296-31



Adson
11-3297-33 33cm/13"

RETRACTORS

Hemilaminectomy Retractor



11-3298-27
 27cm/10½"



Beckmann-Eaton
 11-3299-33
 33 cm/13"

Retractor Only 11-3300-01 Lateral Blades 11-3300-02

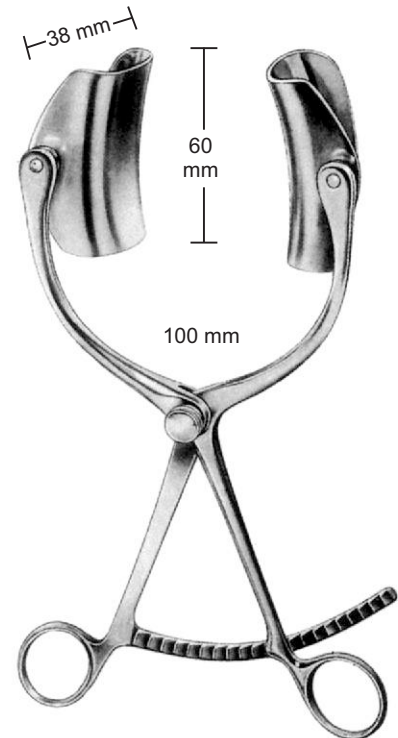

Collin
 11-3300-00
 20cm/8"

RETRACTORS

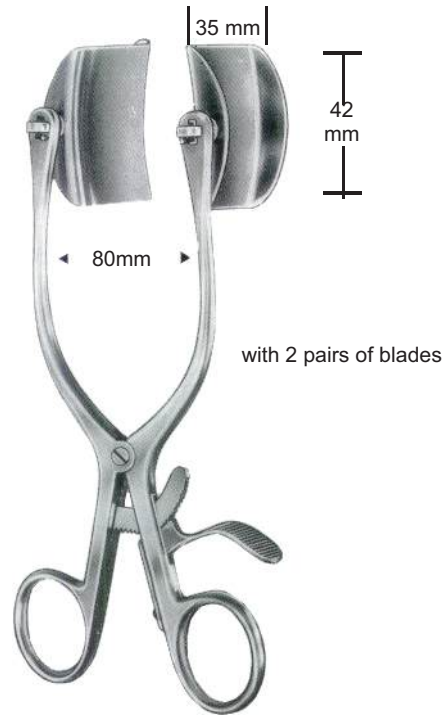

Baby-Collin
11-3301-00

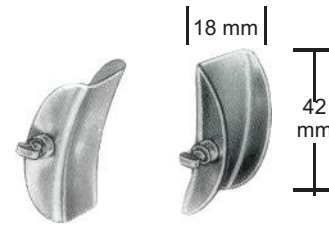

11-3302-01



Collin
20 cm/8"

	Fig. 1 11-3303-00	Fig. 2 11-3304-00	Fig. 3 11-3305-00
Retractors Complete	11-3303-00	11-3304-00	11-3305-00
Retractors Only	11-3303-01	11-3304-01	11-3305-01
Lateral Blades	11-3303-02 38x62 mm	11-3304-02 38x80 mm	11-3305-02 38x100 mm
Central Blades	11-3303-03 55x55 mm		11-3305-03 55x75 mm

RETRACTORS

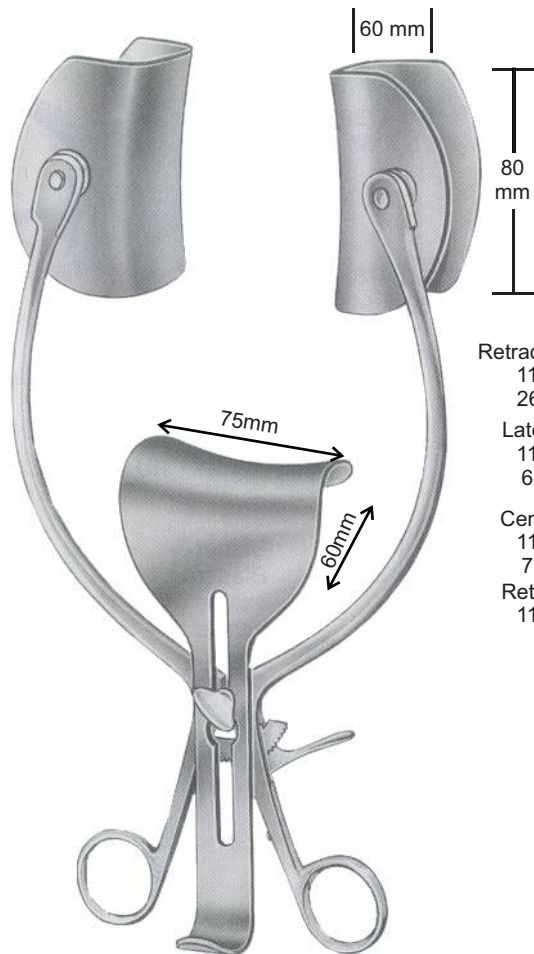

Collin

Retractor Complete
 11-3306-00
 26cm/10½"
 Lateral Blades
 11-3306-01
 60X80mm
 Central Blades
 11-3306-02
 75X60mm
 Retractor Only
 11-3306-03



Mayo-Adams
 11-3307-01
 17cm/6¾"

Mayo-Adams
 11-3307-02
 17cm/6¾"

RETRACTORS

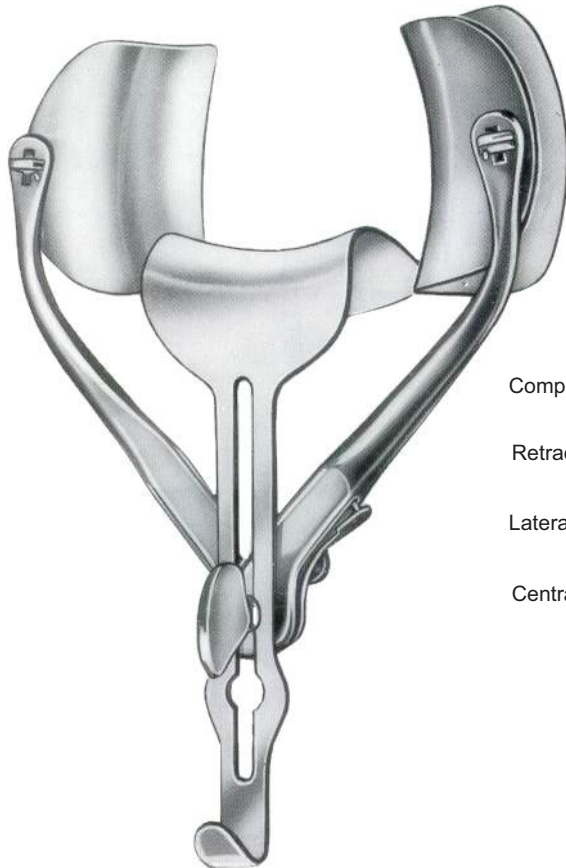

Ricard
11-3308-00 28cm/11"
11-3308-00 30cm/12"

Complete	Fig. 1 11-3309-00	Fig. 2 11-3310-00
Retractors Only	11-3309-01	11-3310-01
Lateral Blades	11-3309-02 60x80 mm	11-3310-02 75x85 mm
Central Only	11-3309-03 53x70 mm	11-3310-03 80x90 mm

Vulval Retractor



Richter
11-3310-16
16.5 cm/6½"



Gelpi
11-3311-09 9 cm/3½"
11-3311-11 11 cm/4½"
11-3311-13 13 cm/5"
11-3311-19 19 cm/7½"



Gelpi
11-3312-19
19 cm/7½"



Meyerding
Fig. 1 11-3313-01
Fig. 2 11-3313-02
Fig. 3 11-3313-03
Fig. 4 11-3313-04
18 cm/7"

Blades

- Fig. 1 1¾"x1"
- Fig. 2 2⅛"x1"
- Fig. 3 2⅜"x1¾"
- Fig. 4 2⅝"x1"

RETRACTORS



Markham-Meyerdung

11-3314-18 18cm/7" 11-3315-18



Rigby

11-3316-19
19cm/7½"



De Bakey

11-3317-12 12cm/4 ¾"
11-3317-17 17cm/6 ¾"



10cm/4"



Gosset
11-3318-00

Fig.1 ◀ 10cm/4" ▶
Fig.2 ◀ 14cm/5½" ▶



Gosset
Fig.1 11-3319-01
Fig.2 11-3319-02

RETRACTORS



Gosset
11-3320-00



Hertzler
11-3321-00

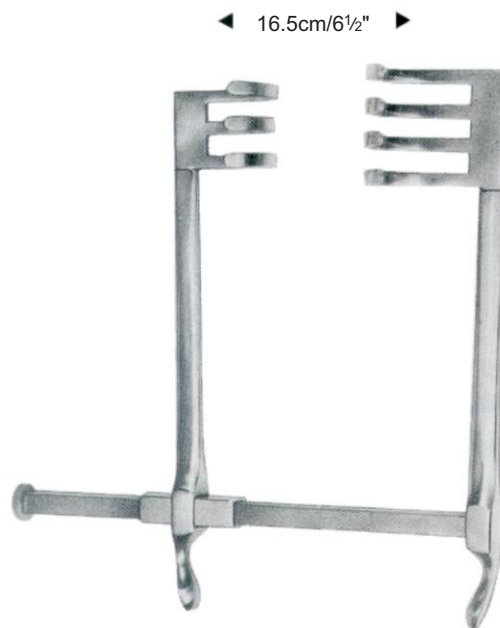

Frazier
11-3322-00

RETRACTORS

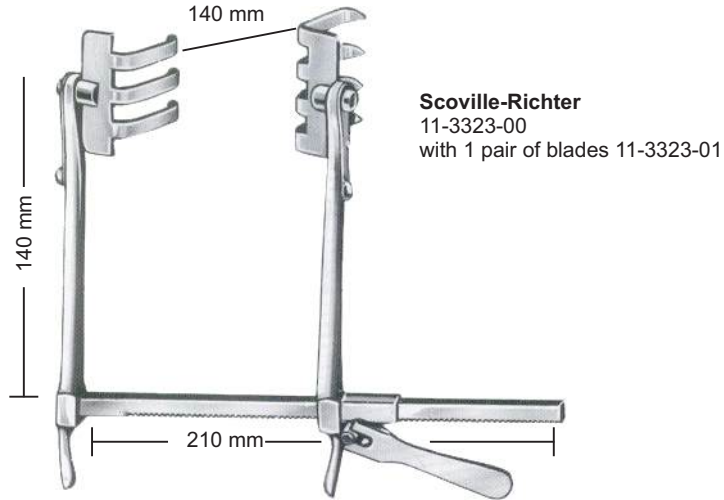

the blades are available by pairs

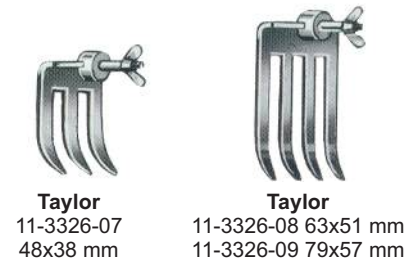
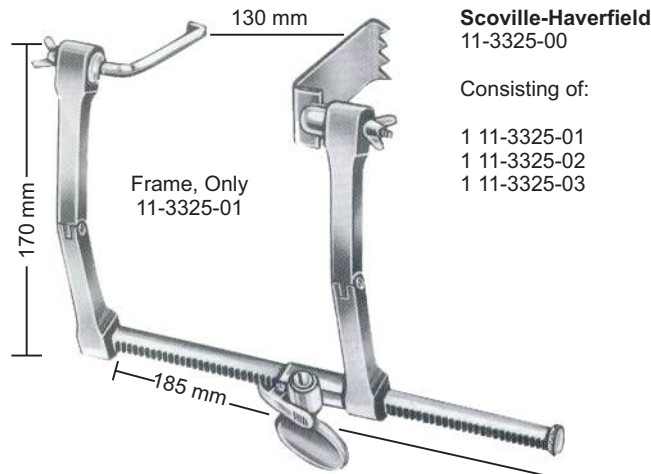
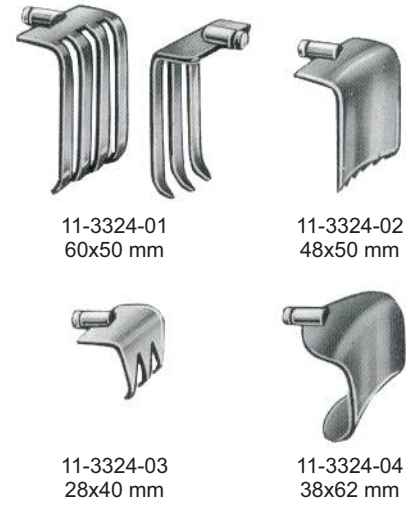

RETRACTORS

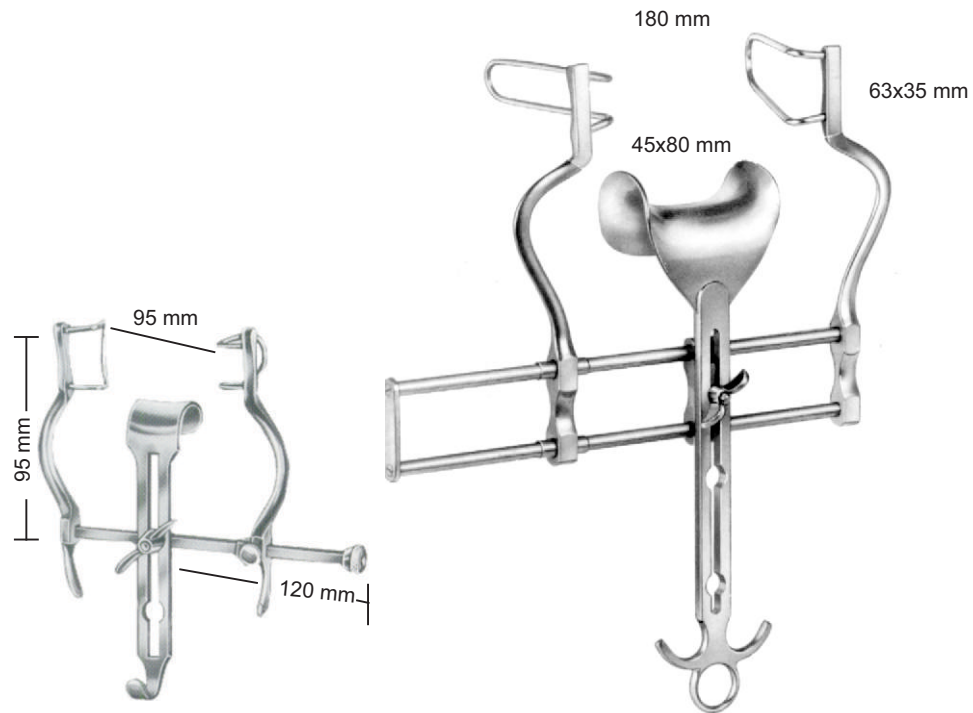

	Baby-Balfour 11-3327-00	Balfour 11-3328-00
Retractor Complete		
Retractor Only	11-3327-01	11-3328-01
Central Blade Only	11-3327-02	11-3328-02

RETRACTORS



Retractor Complete
11-3329-00

Retractor Only
11-3329-01

Central Blade Only
11-3329-02

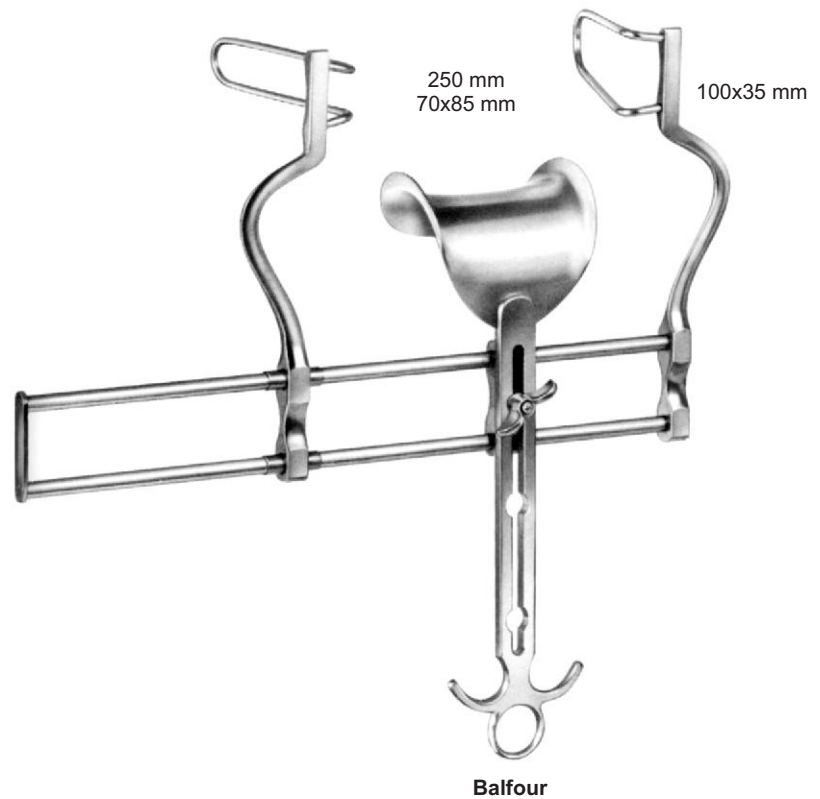

Retractor, Complete
11-3330-00

Retractor Only
11-3330-01

Central Blade Only
11-3330-02

RETRACTORS

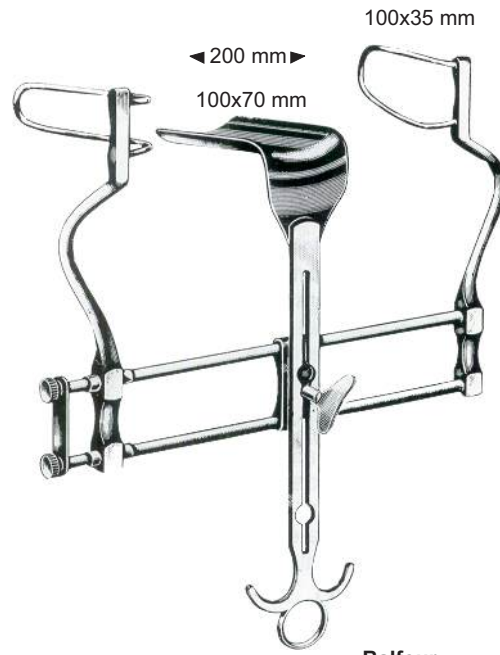

Balfour

- Retractor, complete
11-3331-00

- Retractor, only
11-3331-01

- Central blade, only
11-3331-02

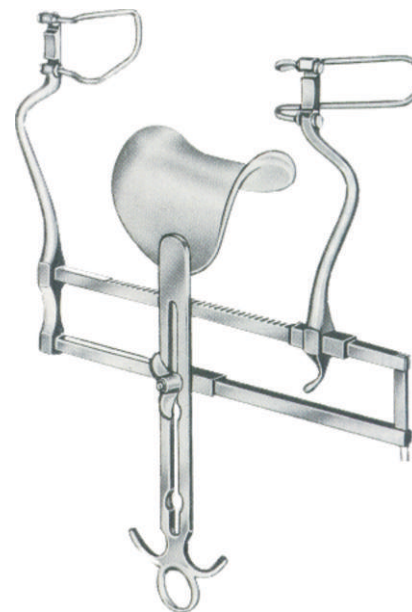

Balfour USA-Modell

- Retractor, complete
11-3332-00

- Retractor, only
11-3332-01

- Central blade, only
11-3332-02
45x68 mm

- Lateral blades, only
11-3332-04
60 mm

- 11-3332-03
68x85 mm

- 11-3332-05
80 mm

RETRACTORS

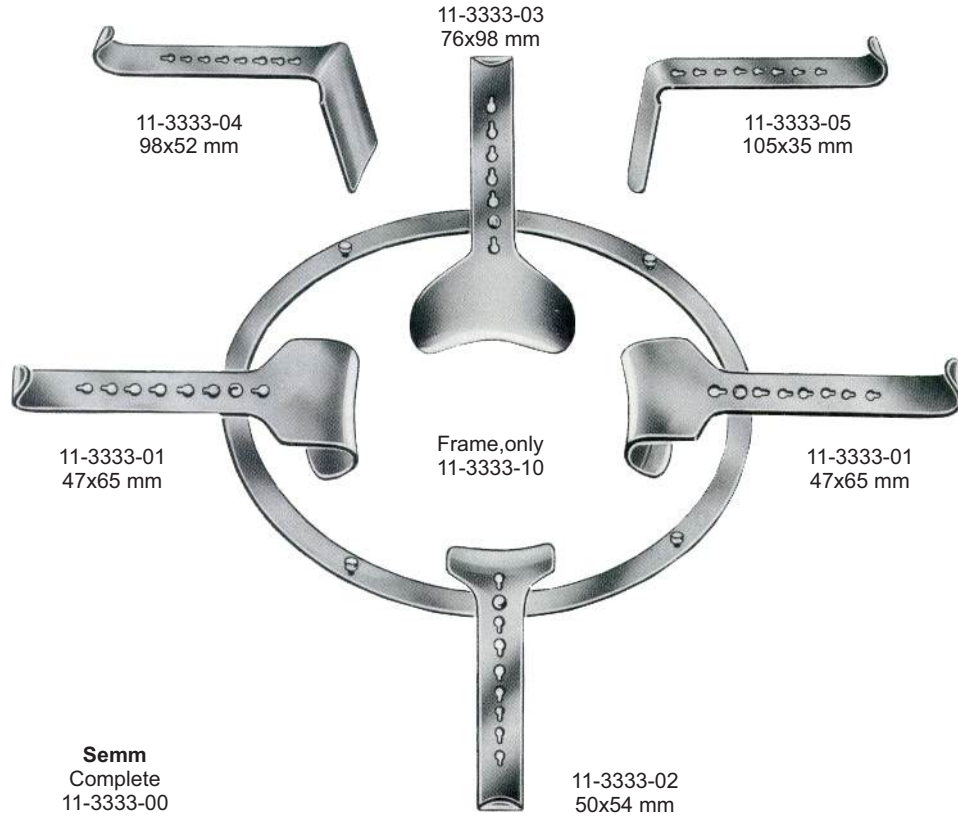

Kirschner
 Complete
 11-3334-00
 1x 11-3334-10
 2x 11-3334-01
 2x 11-3334-02



Kirschner
 Complete
 11-3336-00
 1x 11-3336-10
 2x 11-3336-01
 2x 11-3336-02

RETRACTORS

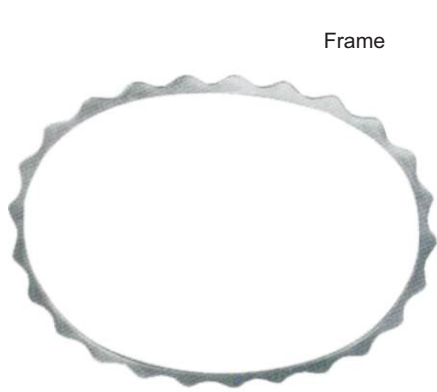

Frame

11-3337-10 178x140 mm
11-3338-20 255x178 mm



Fig.1 11-3337-01 38x38 mm
Fig.2 11-3338-02 38x25 mm

Complete
11-3337-00
11-3338-00

Denis-Brown
Consisting of

1x 11-3337-10
1x 11-3338-20

2x 11-3337-01
2x 11-3338-01

2x 11-3337-02
2x 11-3338-02



110x70 mm

O'Sullivan-O'Connor
Complete
11-3339-00



11-3339-01
80x45 mm



11-3339-02
80x45 mm



11-3339-03
110x70 mm

RETRACTORS



Complete with 4 valves
 11-3340-00

With
 con 11-3340-10 1x
 11-3340-01 2x
 11-3340-03 2x

Complete with 8 valves
 11-3341-00

With
 con 11-3340-10 1x
 11-3340-01 2x
 11-3340-02 2x
 11-3340-03 2x
 11-3340-04 2x



11-3342-01 48x90 mm
 11-3342-02 48x105 mm
 11-3342-03 48x120 mm
 11-3342-04 48x135 mm

Doyen
 28cm/11"

- EN** Bone Surgery
- DE** Knochenchirurgie
- ES** Cirugía ósea

Page 243 to 314



BONE SURGERY



Mead
12-3501-17 17.0cm
26mm Ø, 320 g (11¼ oz)

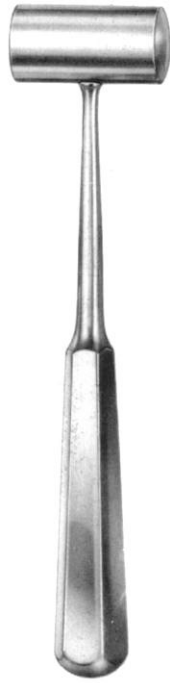

Partsch
12-3502-18 18.0cm
22mm Ø, 200 g (7 oz)

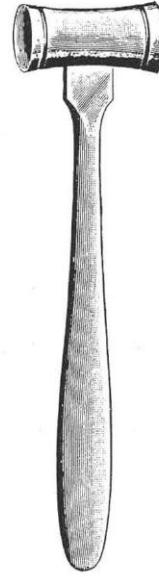

12-3503-30
30mm Ø, 510 g

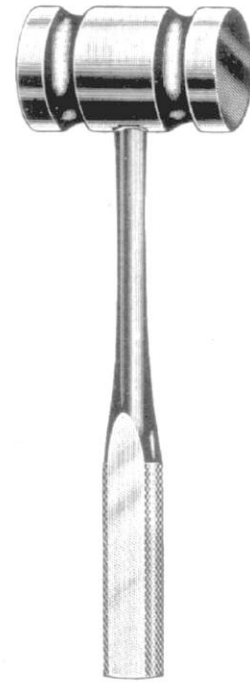

12-3504-25 250 g
12-3505-45 450 g
12-3506-90 900 g
26.5cm

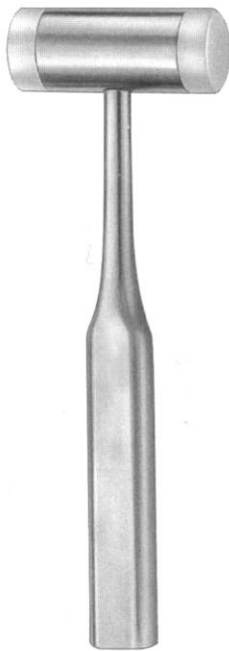

12-3507-18 18.5cm
25mm Ø 135 g



lead filled

12-3508-19 19.0cm
22mm Ø 155 g



Hajek
12-3509-22 22.0cm
27mm Ø 130 g

BONE SURGERY

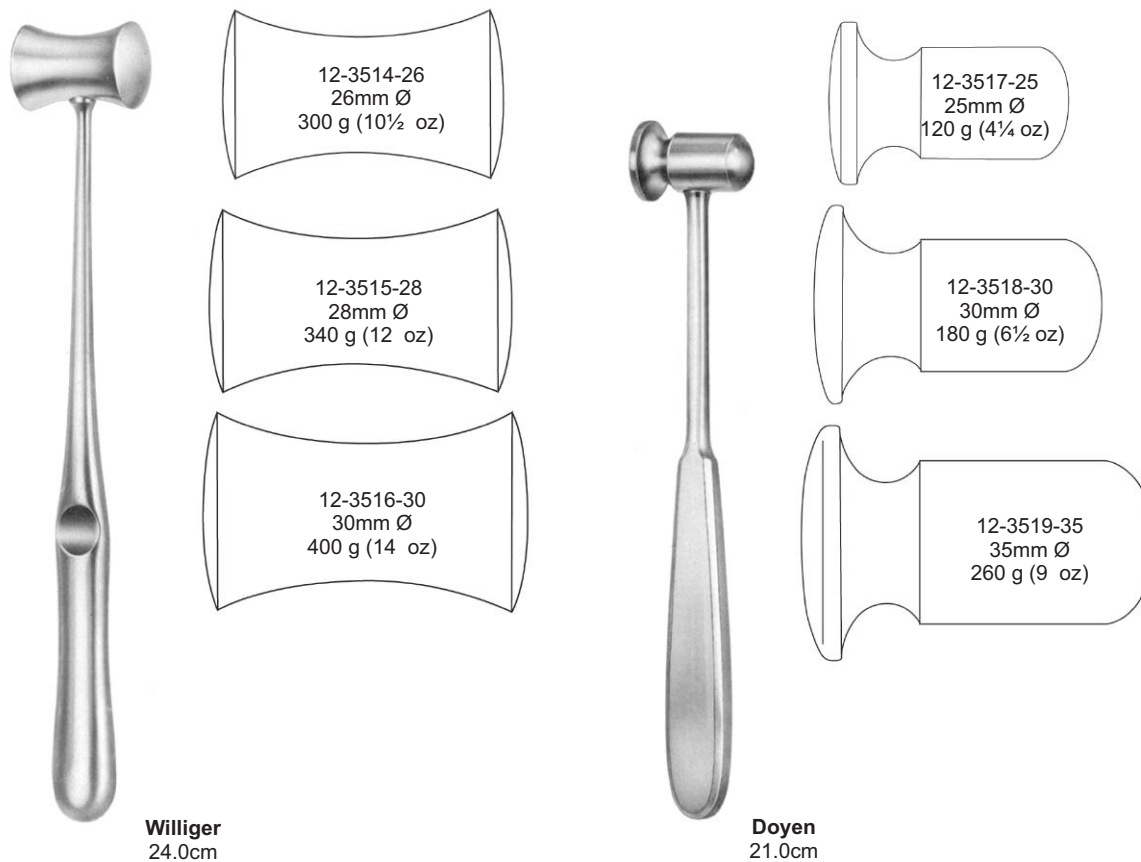
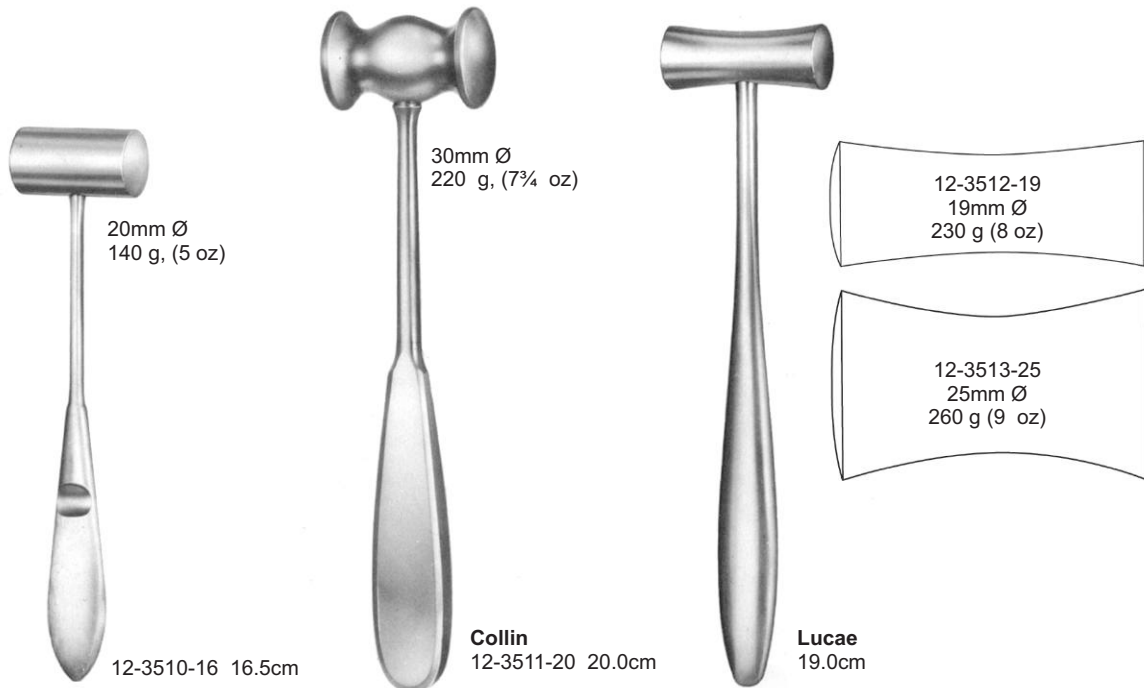

BONE SURGERY

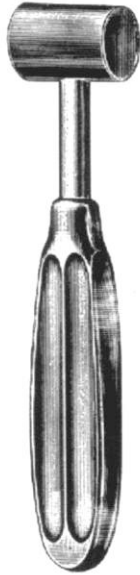

Gerzog
12-3520-18 18.0cm
250 g

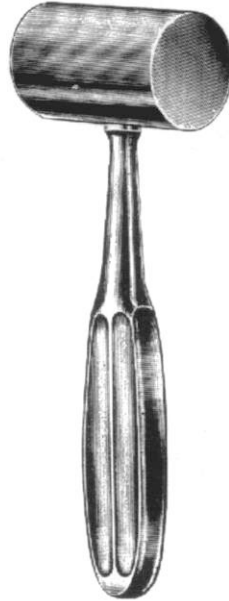

Kirk
12-3521-19 19.0cm
750 g

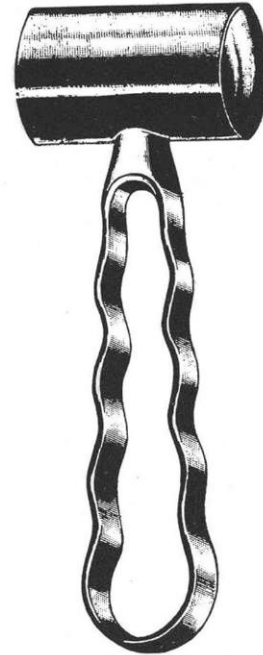

Heath
18.0cm
12-3522-35 35mm Ø (28 oz)
12-3522-40 40mm Ø (36 oz)



12-3523-26
26.5cm 530 g (19 oz)



12-3524-24
24.0cm (30mm Ø 480 g)



12-3525-22
22.5cm (37mm Ø 370 g)



12-3526-24 24.0cm

BONE SURGERY



12-3527-26 26.5cm
30mm Ø, 510 g (18 oz)



12-3528-26 26.5cm



12-3529-25 26.5cm 250 g (0.55 lbs)
12-3529-45 26.5cm 450 g (1 lbs)
12-3529-90 26.5cm 900 g (2 lbs)

BONE SURGERY

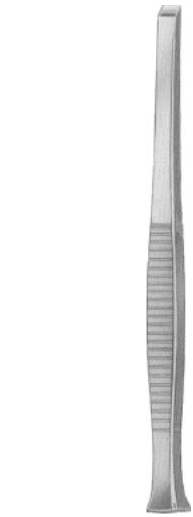

mm
Partsch
 02 12-3530-02
 03 12-3530-03
 04 12-3530-04
 05 12-3530-05
 06 12-3530-06
 07 12-3530-07
 08 12-3530-08
 13.5 cm/5¼"



Partsch
 12-3531-02
 12-3531-03
 12-3531-04
 12-3531-05
 12-3531-06
 12-3531-07
 12-3531-08
 17 cm/6¾"

Partsch
 12-3532-02
 12-3532-03
 12-3532-04
 12-3532-05
 12-3532-06
 12-3532-07
 12-3532-08
 13.5 cm/5¼"

12-3533-04
 12-3533-06
 12-3533-08
 12-3533-10
 12-3533-12
 12-3533-14
 12-3533-16
 17cm/6¾"

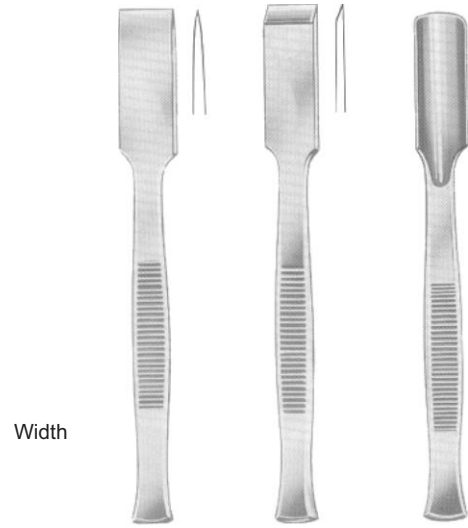

Width

mm
 04 12-3534-04
 06 12-3534-06
 08 12-3534-08
 10 12-3534-10
 12 12-3534-12
 14 12-3534-14
 16 12-3534-16

12-3535-04
 12-3535-06
 12-3535-08
 12-3535-10
 12-3535-12
 12-3535-14
 12-3535-16

12-3536-04
 12-3536-06
 12-3536-08
 12-3536-10
 12-3536-12
 12-3536-14
 12-3536-16

13.5 cm/5¼"

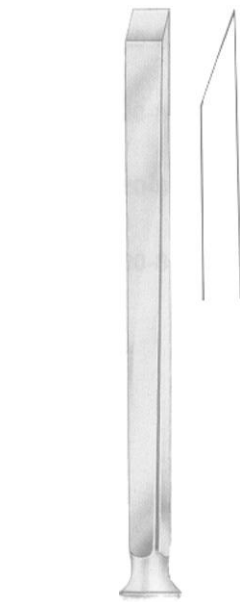

mm
 06 12-3537-06
 12 12-3537-12
 18 12-3537-18

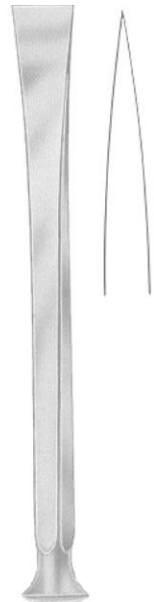

Mod. USA
 12-3538-06
 12-3538-12
 12-3538-18
 16 cm/6¼"



12-3539-06
 12-3539-12
 12-3539-18



16 cm/6¼"



Passow
 12 cm/4¾"

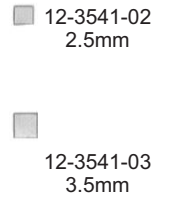

BONE SURGERY



Lexer
27.5 cm/10¾"

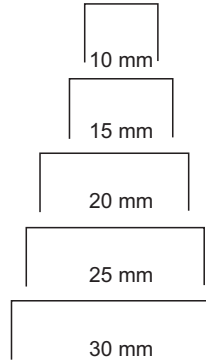

- 12-3542-10
- 12-3542-15
- 12-3542-20
- 12-3542-25
- 12-3542-30

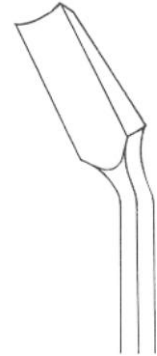

- 12-3543-10
- 12-3543-15
- 12-3543-20
- 12-3543-25
- 12-3543-30



Cloward
24 cm/9½"

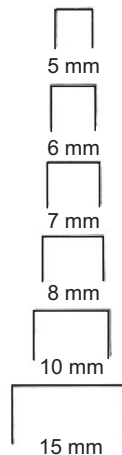

- 12-3544-05
- 12-3544-06
- 12-3544-07
- 12-3544-08
- 12-3544-10
- 12-3544-15



- 12-3545-05
- 12-3545-06
- 12-3545-07
- 12-3545-08
- 12-3545-10
- 12-3545-15

BONE SURGERY



Alexander
18 cm/7"

	mm	
12-3546-04	04	12-3547-04
12-3546-06	06	12-3547-06
12-3546-08	08	12-3547-08
12-3546-10	10	12-3547-10
12-3546-12	12	12-3547-12
12-3546-14	14	12-3547-14

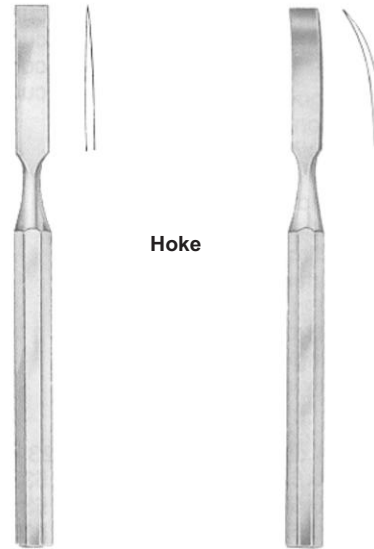

Hoke

14 cm/5½"

	mm	
12-3548-02	2	12-3549-02
12-3548-03	3	12-3549-03
12-3548-04	4	12-3549-04
12-3548-05	5	12-3549-05
12-3548-06	6	12-3549-06
12-3548-07	7	12-3549-07
12-3548-08	8	12-3549-08



Smith-Petersen
20 cm/8"



mm				
06	12-3550-06	12-3551-06	12-3552-06	12-3553-06
09	12-3550-09	12-3551-09	12-3552-09	12-3553-09
13	12-3550-13	12-3551-13		
14			12-3552-14	12-3553-14
16	12-3550-16	12-3551-16	12-3552-16	12-3553-16
19	12-3550-19	12-3551-19	12-3552-19	12-3553-19
25	12-3550-25	12-3551-25	12-3552-25	12-3553-25
32	12-3550-32	12-3551-32	12-3552-32	12-3553-32

BONE SURGERY

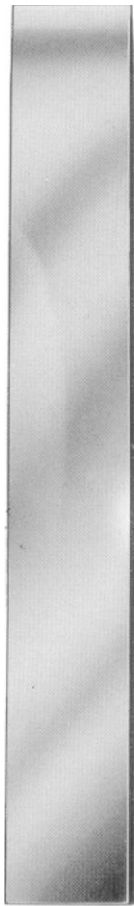

Lambotte

	mm	
12-3554-04	04	12-3555-04
12-3554-06	06	12-3555-06
12-3554-08	08	12-3555-08
12-3554-10	10	12-3555-10
12-3554-13	13	12-3555-13
12-3554-16	16	12-3555-16
12-3554-18	18	12-3555-18
12-3554-20	20	12-3555-20
12-3554-25	25	12-3555-25
12-3554-30	30	12-3555-30
12-3554-38	38	12-3555-38
12-3554-44	44	12-3555-44
12-3554-50	50	12-3555-50

24 cm/9½"

Curved

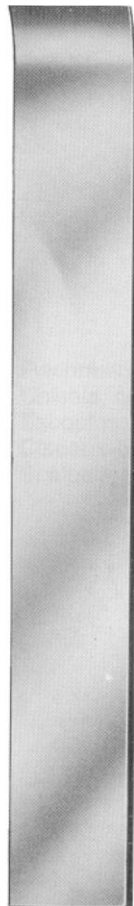

23 cm/9"



Mini-Lambotte

	mm	
12-3556-02	02	12-3557-02
12-3556-03	03	12-3557-03
12-3556-04	04	12-3557-04
12-3556-06	06	12-3557-06
12-3556-08	08	12-3557-08
12-3556-10	10	12-3557-10
12-3556-12	12	12-3557-12
12-3556-15	15	12-3557-15
12.5 cm/5"		17 cm/6¾"



Mini-Lexer

	mm	
12-3558-04	04	12-3559-04
12-3558-06	06	12-3559-06
12-3558-08	08	12-3559-08
12-3558-10	10	12-3559-10
12-3558-12	12	12-3559-12

18 cm/7"



Lexer

	mm	
12-3560-05	05	12-3561-05
12-3560-07	07	12-3561-07
12-3560-10	10	12-3561-10
12-3560-15	15	12-3561-15
12-3560-20	20	12-3561-20
12-3560-25	25	12-3561-25
12-3560-30	30	12-3561-30

22 cm/8¾"



BONE SURGERY



Chisel
12-3562-20
24.5 cm/9 3/4"
20 mm



Chisel-Curved
12-3563-20
26.5 cm/10 1/2"
20 mm



Gouge for the
removing of
broken screws

12-3564-22
22 cm/8 3/4"

BONE SURGERY

Zielke
 23 cm/9"
 5.5 mm
 9.0 mm



12-3565-05
 12-3565-09

Stille
 20 cm/8"

mm
 06
 08
 10
 12
 15
 20
 25
 30

Width

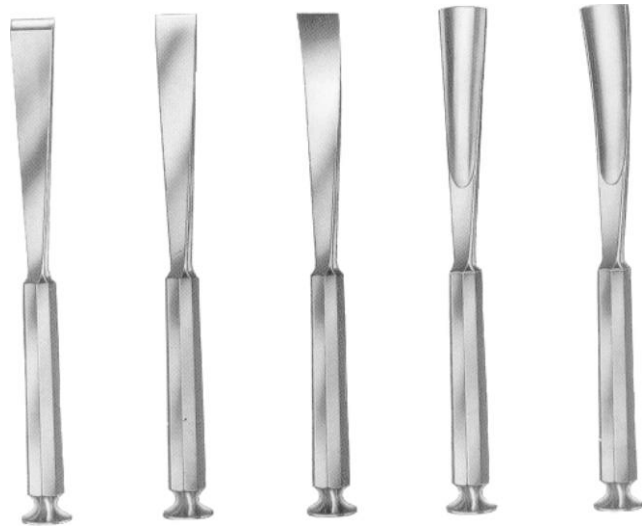

12-3566-06	12-3567-06	12-3568-06	12-3569-06	12-3570-06
12-3566-08	12-3567-08	12-3568-08	12-3569-08	12-3570-08
12-3566-10	12-3567-10	12-3568-10	12-3569-10	12-3570-10
12-3566-12	12-3567-12	12-3568-12	12-3569-12	12-3570-12
12-3566-15	12-3567-15	12-3568-15	12-3569-15	12-3570-15
12-3566-20	12-3567-20	12-3568-20	12-3569-20	12-3570-20
12-3566-25	12-3567-25	12-3568-25	12-3569-25	12-3570-25
12-3566-30	12-3567-30	12-3568-30	12-3569-30	12-3570-30

Hibbs
 24 cm/9½"

mm
 06
 09
 13
 16
 19
 25
 32



12-3571-06	12-3572-06	12-3573-06	12-3574-06	12-3575-06
12-3571-09	12-3572-09	12-3573-09	12-3574-09	12-3575-09
12-3571-13	12-3572-13	12-3573-13	12-3574-13	12-3575-13
12-3571-16	12-3572-16	12-3573-16	12-3574-16	12-3575-16
12-3571-19	12-3572-19	12-3573-19	12-3574-19	12-3575-19
12-3571-25	12-3572-25	12-3573-25	12-3574-25	12-3575-25
12-3571-32	12-3572-32	12-3573-32	12-3574-32	12-3575-32

BONE SURGERY



mm **Lexer**
05 12-3576-05
10 12-3576-10
15 12-3576-15

28 cm/11"



Lexer
12-3577-05
12-3577-10
12-3577-15

25 cm/10"



Lexer
12-3578-05
12-3578-10
12-3578-15

25 cm/10"



12-3579-01



12-3579-02



12-3579-03



Cobb
28 cm/11"

12-3579-04

BONE SURGERY



Putti
12-3580-30
30 cm/12"



Putti
12-3581-27
27 cm/10½"



12-3582-25
25 cm/10"



12-3583-24
24 cm/9½"



12-3584-22
22 cm/8¾"

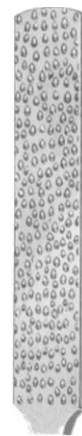

BONE SURGERY



Width

	mm
12-3585-05	05
12-3585-10	10
12-3585-15	15
12-3585-20	20
12-3585-25	25

Lambotte
21 cm/8¼"



Schneider
12-3586-17
13 mm
17.5 cm/7"



Schneider-Sauerbruch
12-3587-19
13 mm
19 cm/7½"



Alexander
12-3588-20
20 cm/8"

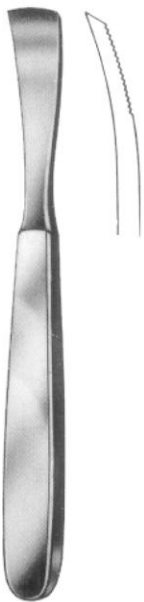

Jansen
12-3589-16
15 mm
16.5 cm/6½"



Seldin
12-3590-19
19 cm/7½"



Davidson-Alexander
12-3591-29
29 cm/11½"

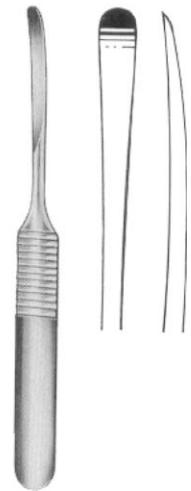

Williger
12-3592-29
13 cm/5"

BONE SURGERY

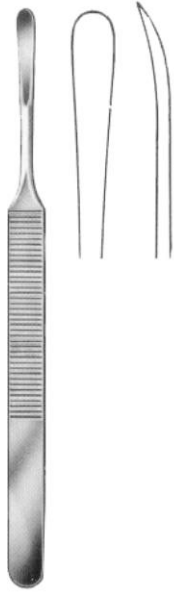

Konig
 12-3593-15
 15.5 cm/6"
 5 mm

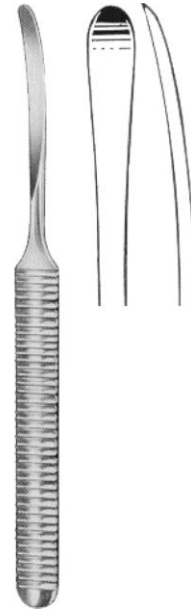

Williger
 12-3594-16
 16 cm/6¼"



Adson
 17 cm/6¾"



12-3595-01



12-3595-02



12-3595-03



12-3595-04

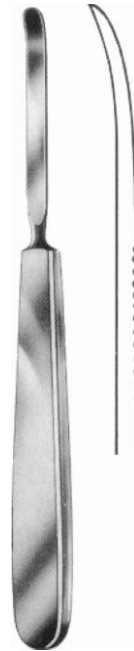

12-3596-06
 6 mm

17 cm/6¾"

12-3597-08
 8 mm

BONE SURGERY

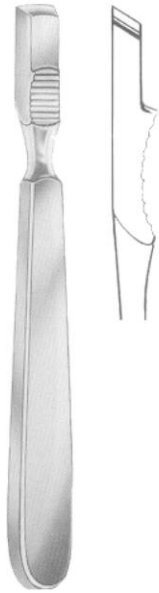

Farabeuf
12-3598-15
15 cm/6"

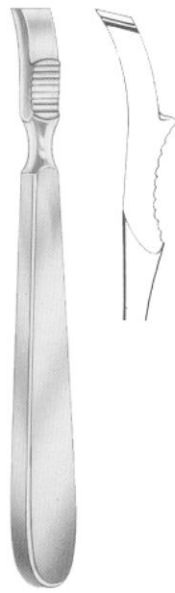

Farabeuf
12-3599-15
15 cm/6"



Farabeuf-Collin
12-3600-15
15.5 cm/6"
11 mm



Farabeuf-Collin
12-3601-15
15.5 cm/6"
11 mm



Farabeuf
12-3602-19
19 cm/7½"
13 mm

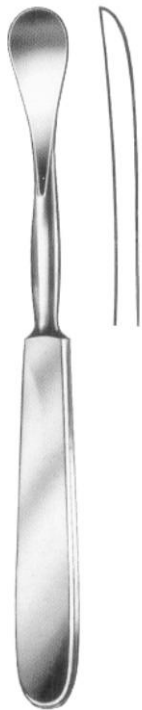

Sedillot
12-3603-18
18 cm/7"
18 mm



Sedillot
12-3604-21
21 cm/8¼"
15 mm



Langenbeck
12-3605-19
19 cm/7½"



Langenbeck
12-3606-18
18 cm/7"

BONE SURGERY



Overholt
 12-3607-29
 29.5 cm/11½"



Overholt
 12-3608-29
 29.5 cm/11½"



Overholt
 12-3609-28
 28.5 cm/11¼"



Hylin
 12-3610-03
 14.5 cm/5¾"



12-3610-01



12-3610-02



12-3610-03



Matson
 12-3611-22
 22 cm/8¾"

BONE SURGERY



Semb

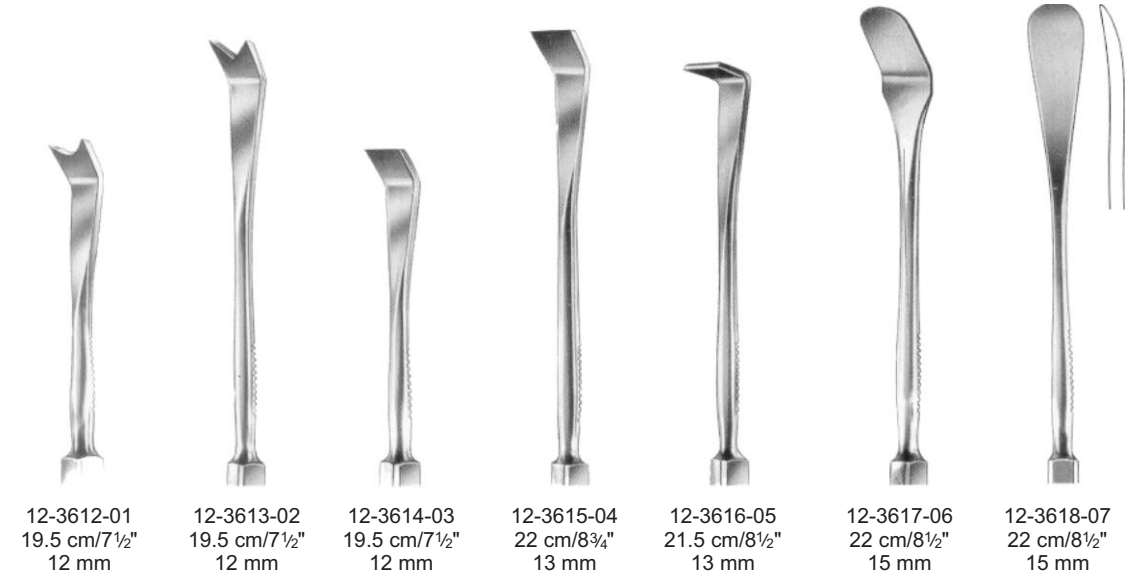

12-3612-01
19.5 cm/7½"
12 mm

12-3613-02
19.5 cm/7½"
12 mm

12-3614-03
19.5 cm/7½"
12 mm

12-3615-04
22 cm/8¾"
13 mm

12-3616-05
21.5 cm/8½"
13 mm

12-3617-06
22 cm/8½"
15 mm

12-3618-07
22 cm/8½"
15 mm



Doyen
17 cm/6¾"

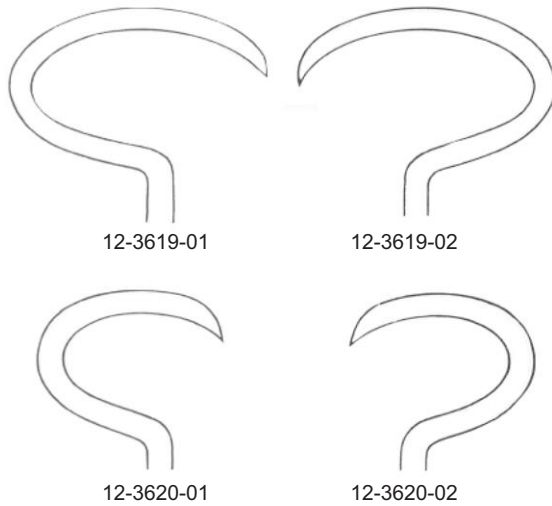

12-3619-01

12-3619-02

12-3620-01

12-3620-02



12-3621-01

Doyen
24 cm/9½"

12-3622-02

BONE SURGERY



12-3623-04
4 mm



12-3623-06
6 mm



12-3623-08
8 mm

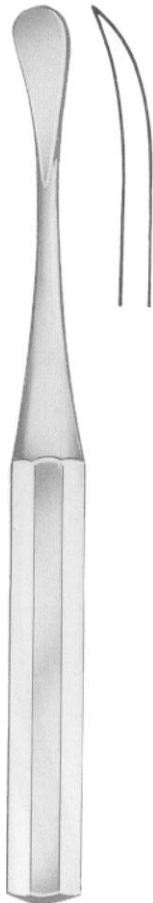

Cobb
24 cm/9½"



12-3623-10
10 mm



12-3623-13
13 mm



12-3623-19
19 mm



12-3623-25
25 mm

BONE SURGERY



12-3624-01
19 cm/7½"
6 mm



12-3625-02
18.5 cm/7¼"
3 mm



12-3626-03
18.5 cm/7¼"
6 mm



12-3627-04
18.5 cm/7¼"
6 mm

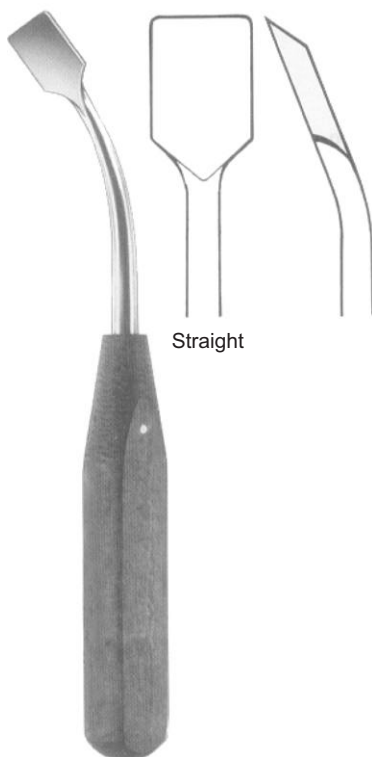

12-3628-05
18.5 cm/7¼"
13 mm



12-3629-06
19.5 cm/7¾"
14 mm



12-3630-07
18.5 cm/7¼"
14 mm

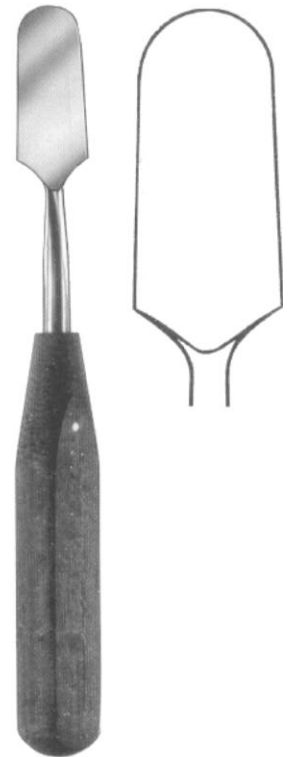

12-3631-08
20 cm/8"
20 mm

BONE SURGERY



12-3632-20
 27.5 cm/10¾"
 20 mm



Wagner
 8 mm 12-3633-08 33 cm/13"
 17 mm 12-3633-17 33 cm/13"



Cobb
 10 mm 12-3634-10 25 cm/10"
 13 mm 12-3634-13 25 cm/10"
 19 mm 12-3634-19 25 cm/10"
 25 mm 12-3634-25 25 cm/10"



Cobb
 10 mm 12-3635-10 28 cm/11"
 13 mm 12-3635-13 28 cm/11"
 19 mm 12-3635-19 28 cm/11"

BONE SURGERY

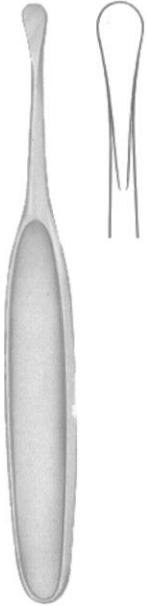

Hoen

12-3636-07
16 cm/6¼"
7 mm

12-3636-15
18.5 cm/7¼"
15 mm

12-3636-20
19 cm/7½"
20 mm



Yankauer
12-3637-18
18 cm/7"



Langenbeck
12-3638-20
20 cm/8"
8 mm



Langenbeck
12-3639-20
20 cm/8"
10 mm



Langenbeck
12-3640-23
23 cm/9"
11 mm



Mass. Gen. Hosp.
12-3641-15
15 cm/6"



Williger
12-3642-17
17 cm/6¾"
5.5 mm



Williger
12-3643-16
16 cm/6¼"



Quervain
12-3644-20
20 cm/8"

BONE SURGERY

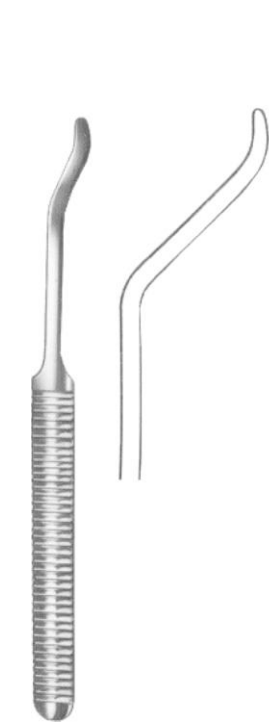

12-3645-16
16 cm/6 1/4"

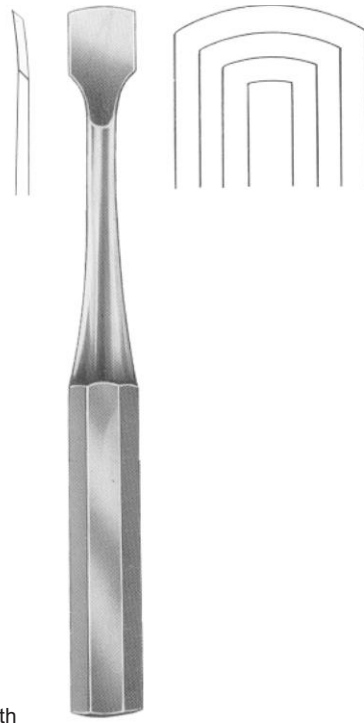

Width

Width	Key	Length
6 mm	12-3646-06	19 cm/7 1/2"
12 mm	12-3646-12	19 cm/7 1/2"
19 mm	12-3646-19	19 cm/7 1/2"
25 mm	12-3646-25	19 cm/7 1/2"

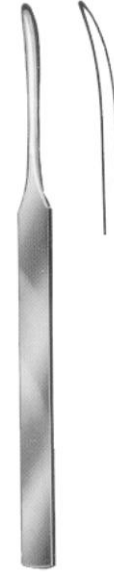

König
12-3647-15
15 cm/6"
4.5 mm

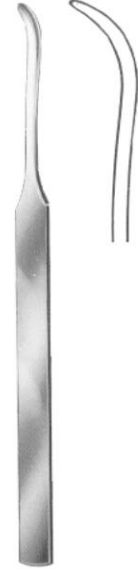

König
12-3648-15
15 cm/6"
4.5 mm



Alderdyce
12-3649-21
21 cm/8 1/4"

McDonald
12-3650-19
19 cm/7 1/2"

Watson-Cheyne
12-3651-19
17.5 cm/7"

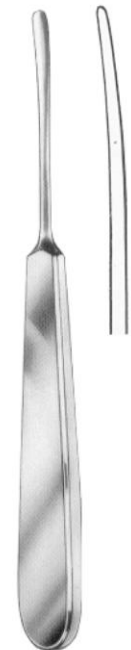

Sebilleau
12-3652-17
17 cm/6 3/4"

BONE SURGERY



12-3653-14
14 cm/5½"
2.8 mm

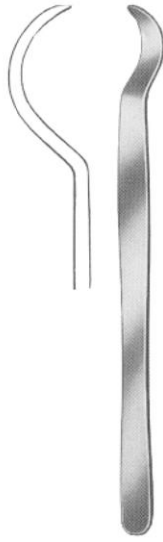

12-3654-15
15 cm/6"
5 mm



12-3655-15
15 cm/6"
7 mm

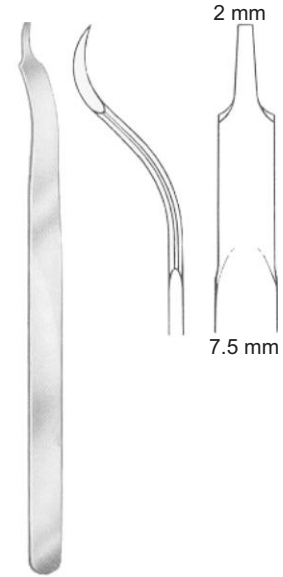

Buck-Gramcko
12-3656-15
15 cm/6"

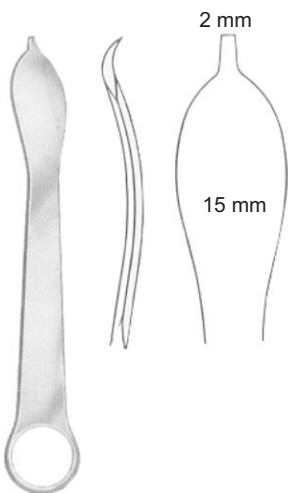

12-3657-12
12.5 cm/5"

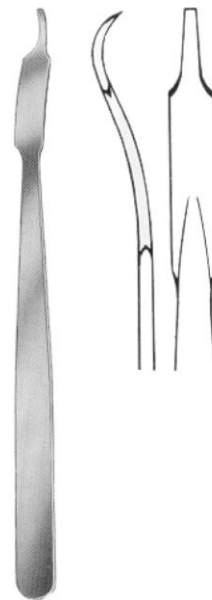

Mini-Hohmann
12-3658-06
16 cm/6¼"



12-3658-08
8 mm

BONE SURGERY



12-3659-17
17 mm

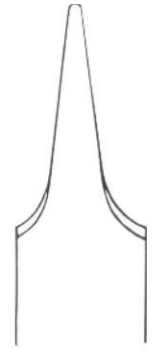

12-3660-17
17 mm

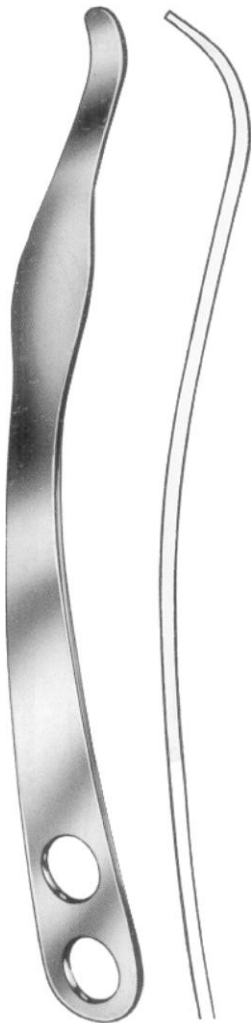

12-3661-26
26.5 cm/10½"
24 mm



Lange-Hohmann
12-3662-26
26 cm/10¼"
22 mm



Hohmann
12-3663-22
22 cm/8¾"
8 mm

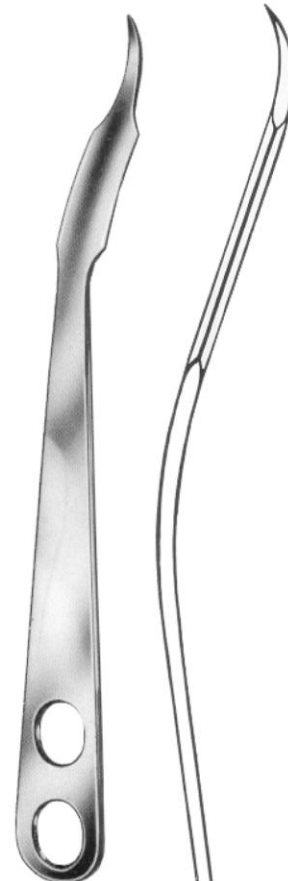

Hohmann
12-3664-24
24 cm/9½"
14mm

BONE SURGERY



Hohmann
12-3665-26
26 cm/10 1/4"
22 mm

Hohmann
12-3666-28
28 cm/11"
33 mm

Hohmann
12-3667-24
24 cm/9 1/2"
43 mm

Hohmann
12-3668-24
24.5 cm/9 3/4"
43 mm

Hohmann
12-3669-24
24 cm/9 1/2"
70 mm

Hohmann
12-3670-22
22 cm/8 3/4"
18 mm

BONE SURGERY

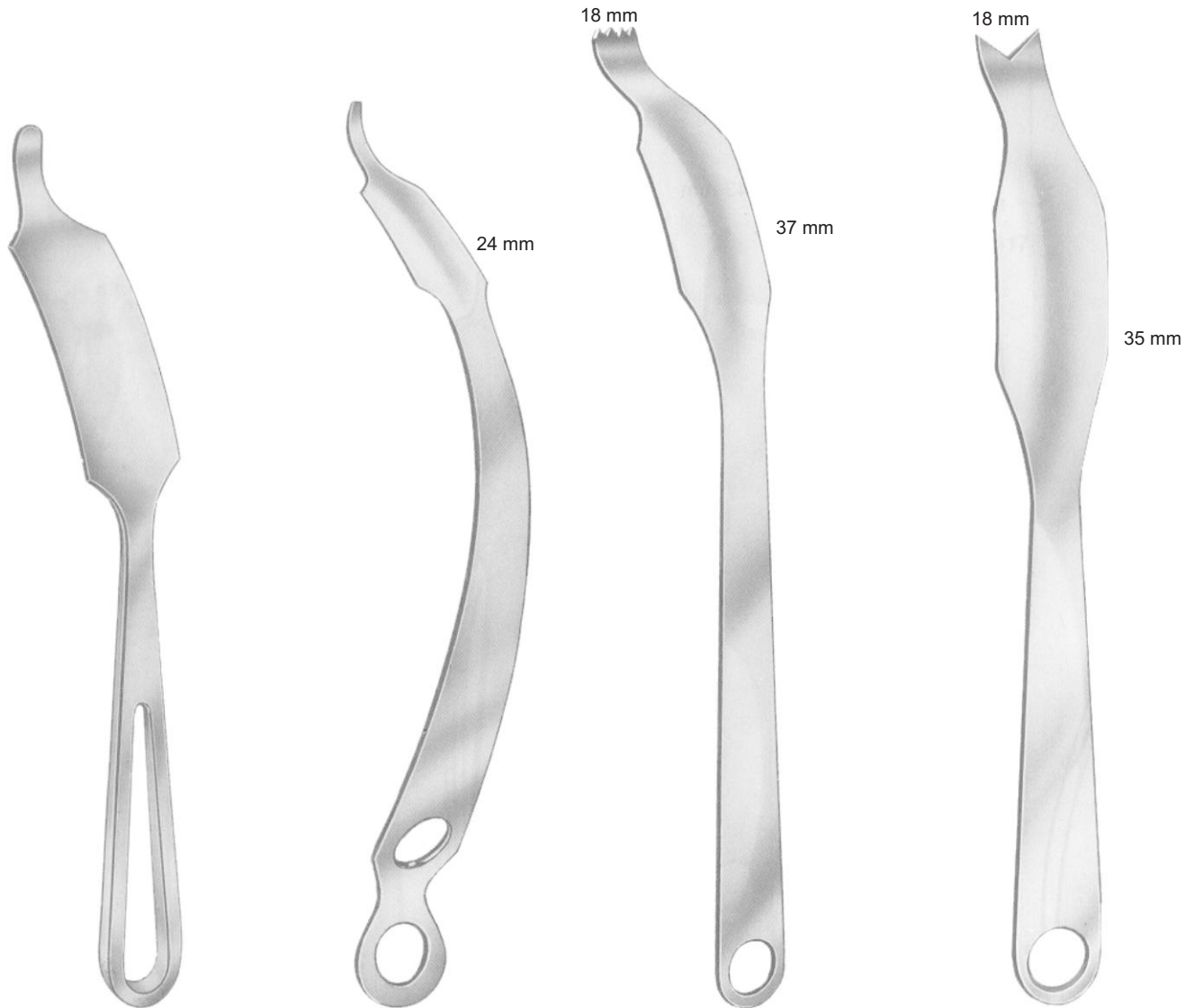

Lange-Hohmann modif
 30 mm 12-3671-26 26.5 cm/10½"
 33 mm 12-3671-29 29.0 cm/11½"

Hohmann-Aldinger
 12-3672-27
 27 cm/10½"

Schumacher
 (Wagner)
 12-3673-34
 34.5 cm/13½"

Schumacher
 12-3674-29
 29 cm/11½"

BONE SURGERY



Smillie
14 cm/5½"

12-3675-01
32x19 mm

12-3675-02
48x19 mm

12-3675-03
57x19 mm



12-3675-04
52x13 mm



12-3675-05
12x13 mm

Spinal retractors



12-3676-01
75x30 mm

12-3676-02
100x30 mm

Taylor
17 cm/6½"



12-3677-21
21.5 cm/8½"

Meniscus retractors



Blount
12-3678-17
17.5 cm/7"

BONE SURGERY

Murphy-Lane
 12-3679-32
 32 cm/12½"



Chandler

Length	Width	
18 cm	13 mm	12-3680-13
20 cm	19 mm	12-3680-19
23 cm	25 mm	12-3680-23
25 cm	30 mm	12-3680-30



Blount
 12-3681-26
 26 cm/10¼"

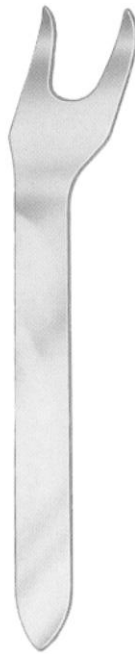

Blount
 12-3682-26
 26 cm/10¼"



Bennett
 12-3683-44 44 mm
 24 cm/9½" 12-3683-64 64 mm

BONE SURGERY



Smillie
12-3684-17
17 cm/6¾"



Smillie
12-3685-17
17 cm/6¾"

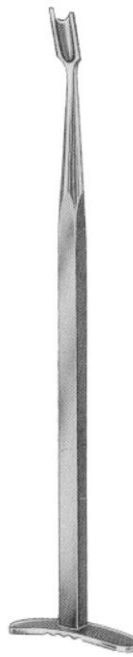

Smillie
12-3686-17
17 cm/6¾"



Salenius
12-3687-22
22 cm/8¾"



Salenius
12-3688-22
22 cm/8¾"

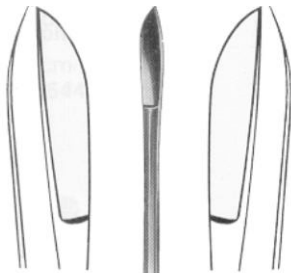

12-3689-17
17.5 cm/7"



Neff
12-3690-21
21.5 cm/8½"



Canad-Modell
12-3691-01 20 cm/8"



12-3692-02



Bircher
12-3693-20
20.5 cm/8"

BONE SURGERY

Drill guide and dura protecting forceps



Adson
 12-3694-15
 15 cm/6"

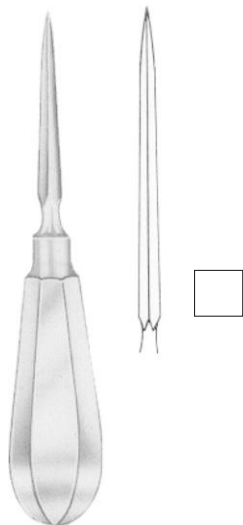

12-3695-14
 14 cm/5½"



Perthes
 12-3696-21
 21 cm/8¼"

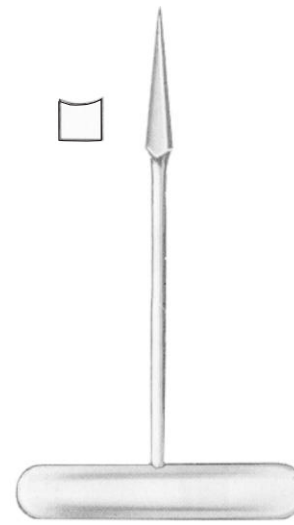

12-3697-14
 14 cm/5½"

BONE SURGERY

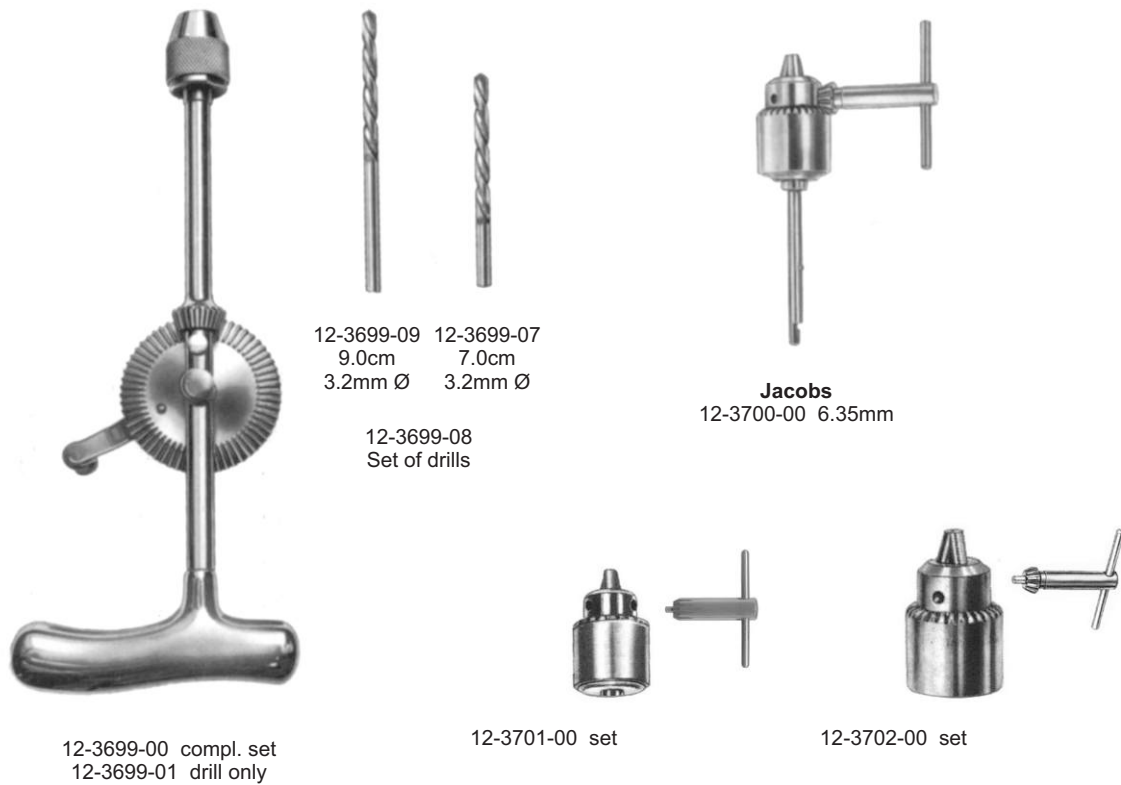
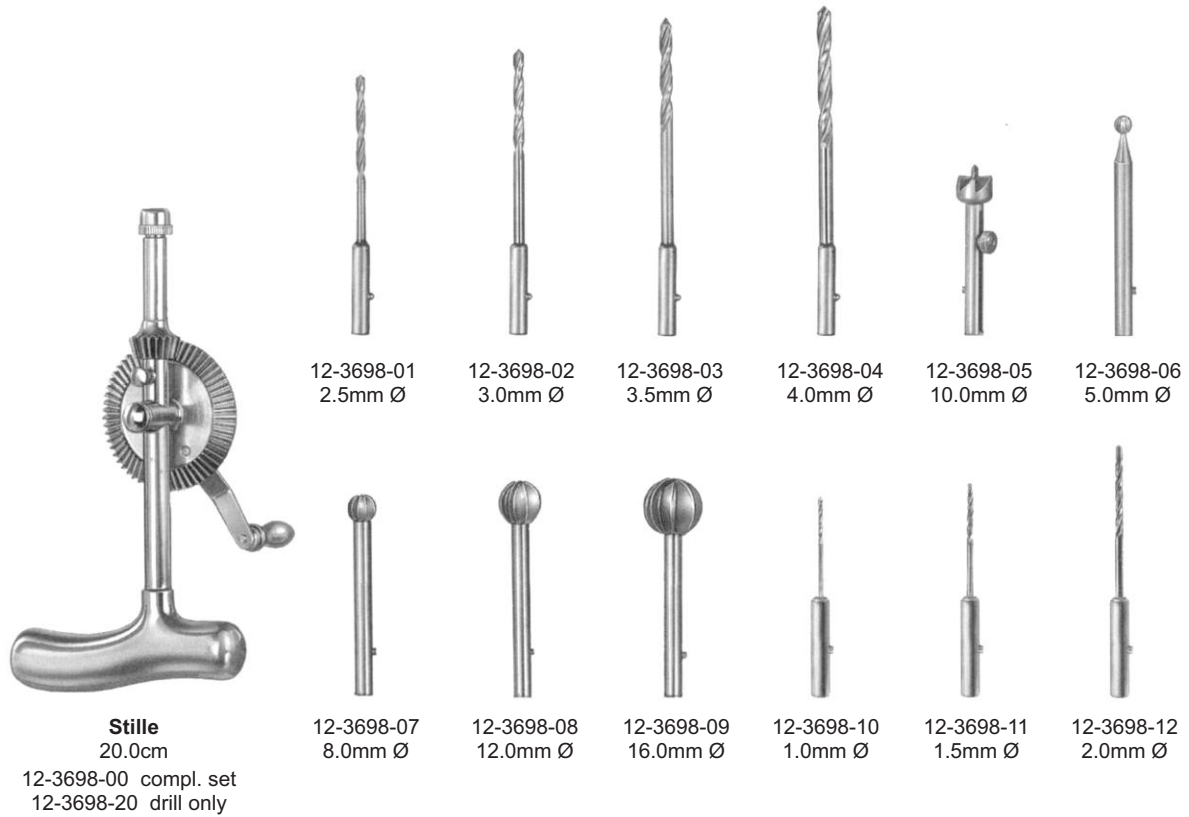

BONE SURGERY



Stille-Sherman
24.0cm

12-3703-00 compl. set
 12-3703-24 drill only



12-3703-25
2.5mm Ø



12-3703-30
3.0mm Ø



12-3703-35
3.5mm Ø



Hudson
12-3704-00

compl. set / 6
 (12-3704,01,
 02,03,07,09)
 12-3704-27
 handle only



12-3704-01
9mm Ø



12-3704-02
14mm Ø



12-3704-03
16mm Ø



12-3704-04
22mm Ø



Cushing
12-3704-05
14mm Ø



12-3704-06
2mm Ø



Mckenzie
12-3704-07
13mm Ø



Errico
12-3704-08
16mm Ø



12-3704-09

BONE SURGERY

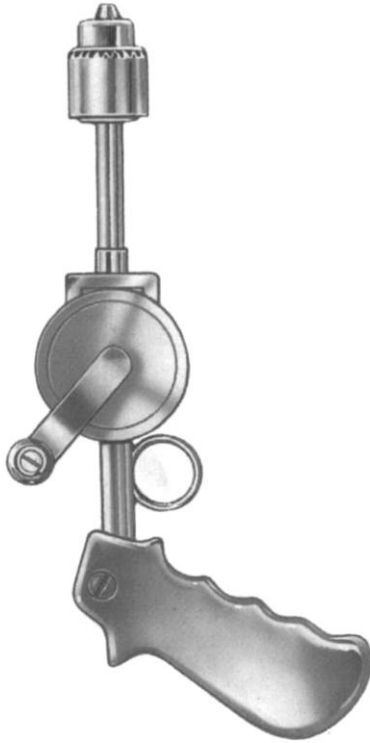

12-3705-00



12-3706-00



12-3707-00

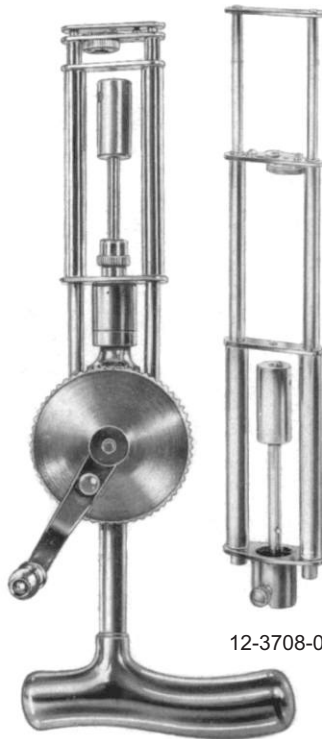

12-3708-01

12-3708-00 complete set



12-3709-01

12-3709-02

12-3709-03

Kirschner
12-3709-00 complete set

BONE SURGERY

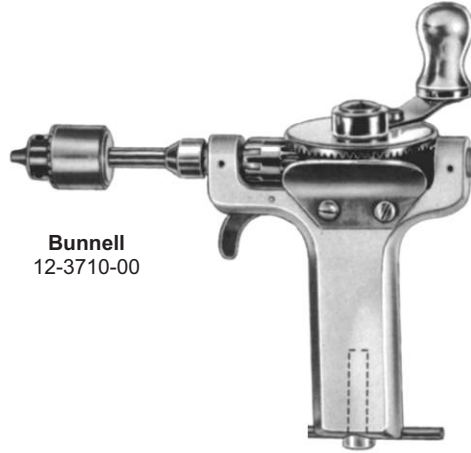

Bunnell
12-3710-00



Ralk
12-3711-00

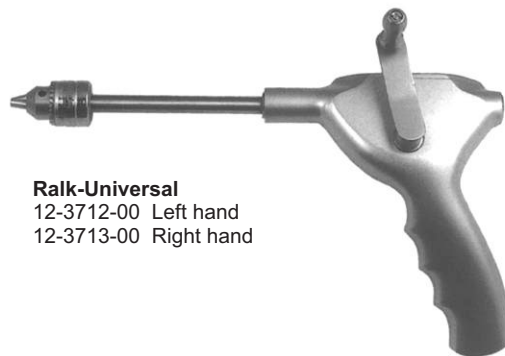

Ralk-Universal
12-3712-00 Left hand
12-3713-00 Right hand

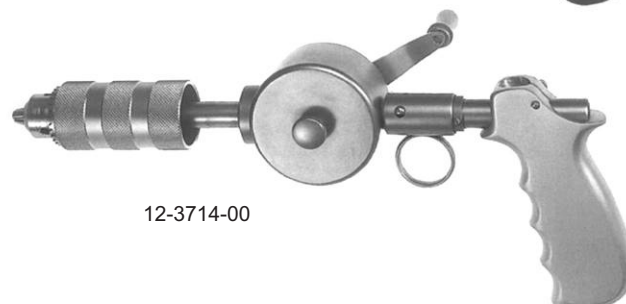

12-3714-00

BONE SURGERY



Spare Saw Blade
12-3715-12 12mm
12-3715-15 15mm
12-3715-18 18mm



Charriere
12-3715-35 35.0cm



Spare Saw Blade
12-3716-03 3mm
12-3716-05 5mm
12-3716-07 7mm



Helferich-Bier
12-3716-39 39.0cm



Lindemann
12-3717-20 20.0cm



Langenbeck
12-3718-23 23.0cm

12-3719-06 6mm
12-3719-08 8mm
12-3719-12 12mm
12-3719-15 15mm
12-3719-18 18mm

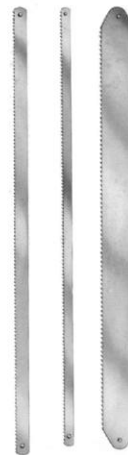

Rust
12-3719-39 39.0cm

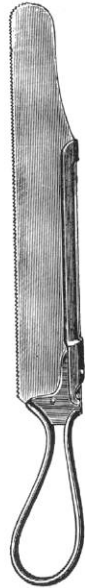

BONE SURGERY

Charriere
 12-3720-27 27.0cm
 12-3720-30 30.0cm
 12-3720-34 34.0cm

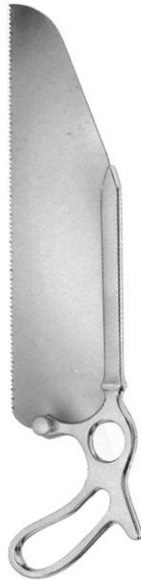

Satterlee
 12-3721-31 31.0cm



Charriere
 12-3722-27 27.0cm
 12-3722-30 30.0cm



Satterlee
 12-3723-31
 31.0cm

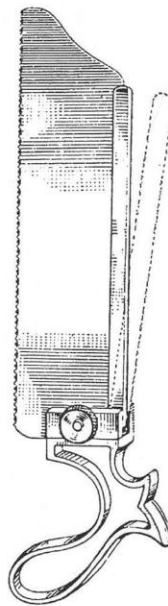

12-3724-23
 23.0cm

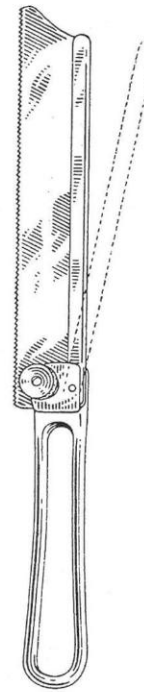

12-3725-19
 19.0cm

BONE SURGERY

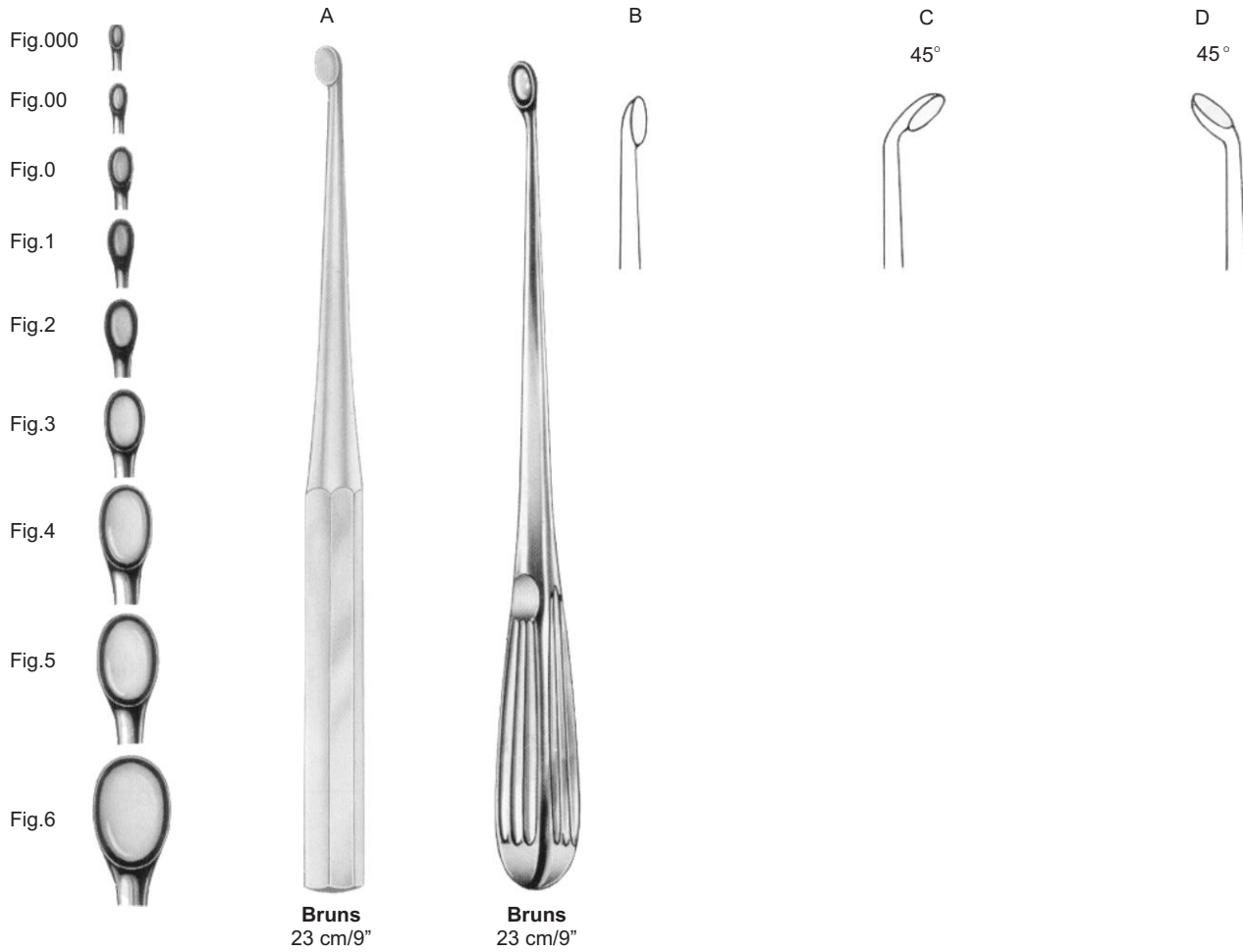
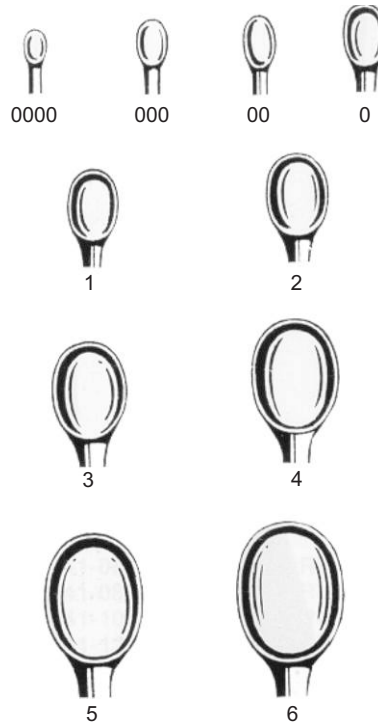

Fig.	A	B	C	D
000	12-3726-30	12-3727-30	12-3728-30	12-3729-30
00	12-3726-20	12-3727-20	12-3728-20	12-3729-20
0	12-3726-10	12-3727-10	12-3728-10	12-3729-10
1	12-3726-01	12-3727-01	12-3728-01	12-3729-01
2	12-3726-02	12-3727-02	12-3728-02	12-3729-02
3	12-3726-03	12-3727-03	12-3728-03	12-3729-03
4	12-3726-04	12-3727-04	12-3728-04	12-3729-04
5	12-3726-05	12-3727-05	12-3728-05	12-3729-05
6	12-3726-06	12-3727-06	12-3728-06	12-3729-06

BONE SURGERY



Volkman
 17 cm/6¾"



- Fig.
 0000 12-3730-40
 000 12-3730-30
 00 12-3730-20
 0 12-3730-10
 1 12-3730-01
 2 12-3730-02
 3 12-3730-03
 4 12-3730-04
 5 12-3730-05
 6 12-3730-06



Volkman
 17 cm/6¾"

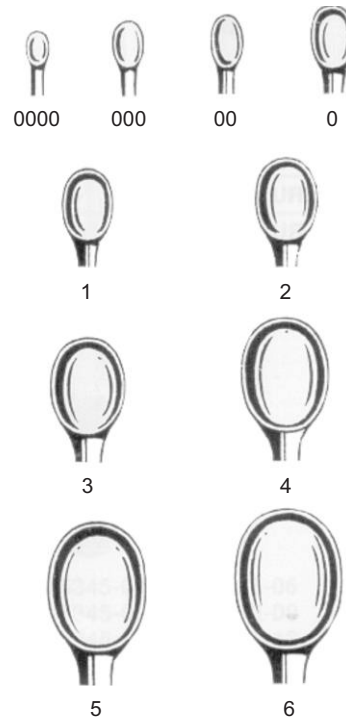

- Fig.
 0000 12-3731-40
 000 12-3731-30
 00 12-3731-20
 0 12-3731-10
 1 12-3731-01
 2 12-3731-02
 3 12-3731-03
 4 12-3731-04
 5 12-3731-05
 6 12-3731-06

BONE SURGERY

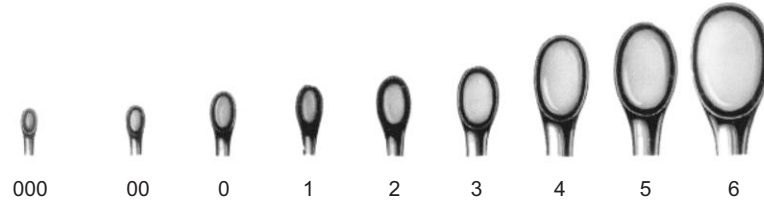

12-3732-21
21 cm/8 1/4"



Epstein



Spinal



Spinal

Fig.			
000	12-3733-30	12-3734-30	12-3735-30
00	12-3733-20	12-3734-20	12-3735-20
0	12-3733-10	12-3734-10	12-3735-10
1	12-3733-01	12-3734-01	12-3735-01
2	12-3733-02	12-3734-02	12-3735-02
3	12-3733-03	12-3734-03	12-3735-03
4	12-3733-04	12-3734-04	12-3735-04
5	12-3733-05	12-3734-05	12-3735-05
6	12-3733-06	12-3734-06	12-3735-06
	20 cm/8"	20 cm/8"	20 cm/8"

BONE SURGERY



	Volkman	Volkman
Length	Oval/Oval	Oval/Round
cm		
in		
13 5"	12-3736-13	12-3737-13
14 5½"	12-3736-14	
16 6¼"		12-3737-16
17 6¾"	12-3736-17	
20 8"	12-3736-20	12-3737-20



Martini
13.5 cm/5"



Jansen
12-3739-15
15 cm/6"



Jansen
12-3740-16
16 cm/6¼"



Williger
13.5 cm/5"



Jacobson
12-3742-13
13 cm/5"



Janson
12-3743-15
15 cm/6"



Barth
12-3744-18
18 cm/7"

BONE SURGERY

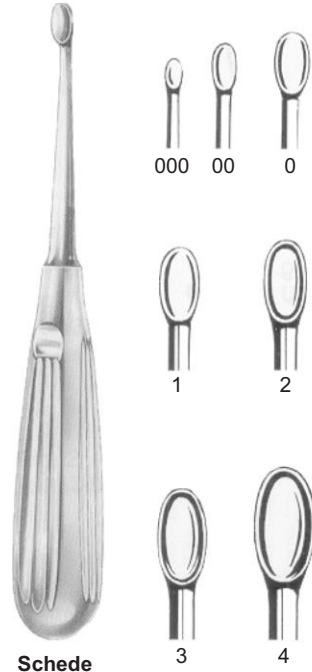

Schede
17 cm/6¾"

Fig.	
000	12-3745-30
00	12-3745-20
0	12-3745-10
1	12-3745-01
2	12-3745-02
3	12-3745-03
4	12-3745-04

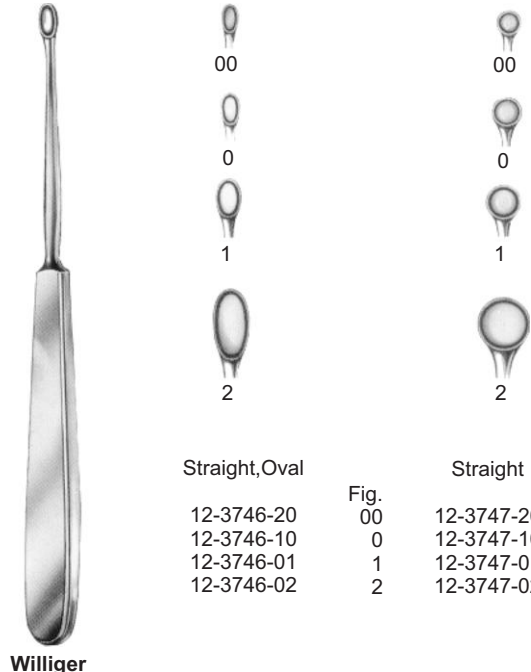

Williger
17.5 cm/7"

Straight, Oval		Straight	
Fig.		Fig.	
00	12-3746-20	00	12-3747-20
0	12-3746-10	0	12-3747-10
1	12-3746-01	1	12-3747-01
2	12-3746-02	2	12-3747-02

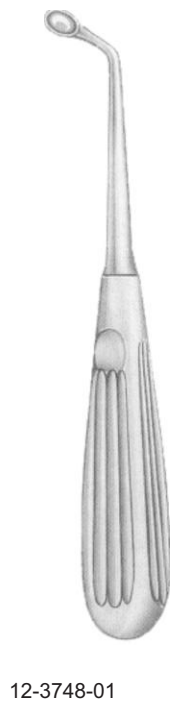

12-3748-01

Uffenorde
17 cm/6¾"

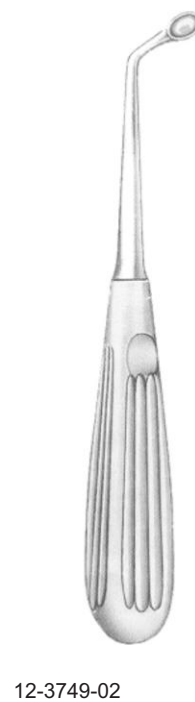

12-3749-02

BONE SURGERY

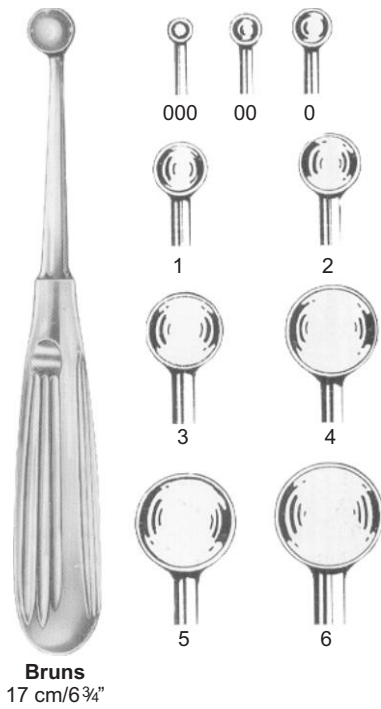

Brun's
17 cm/6¾"

Brun's	Fig.	Spratt
12-3750-30	000	12-3751-30
12-3750-20	00	12-3751-20
12-3750-10	0	12-3751-10
12-3750-01	1	12-3751-01
12-3750-02	2	12-3751-02
12-3750-03	3	12-3751-03
12-3750-04	4	12-3751-04
12-3750-05	5	12-3751-05
12-3750-06	6	12-3751-06

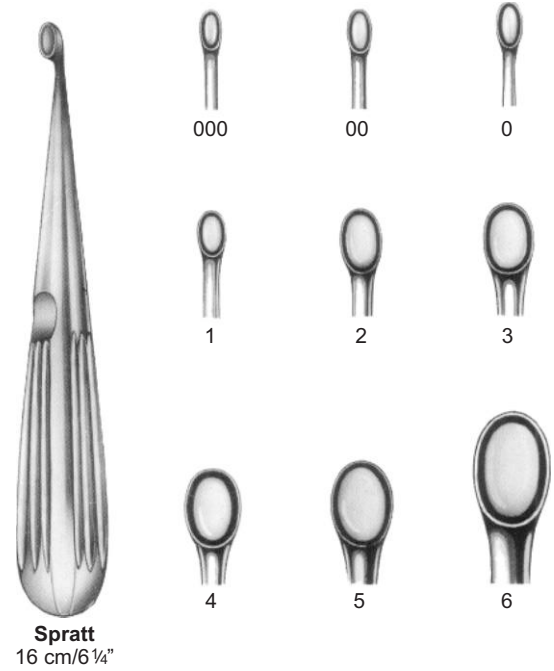

Spratt
16 cm/6¼"



Swedish pattern

mm	Round	Oval
2	12-3752-02	12-3753-02
3	12-3752-03	12-3753-03
4	12-3752-04	12-3753-04
5	12-3752-05	12-3753-05
6	12-3752-06	12-3753-06
7	12-3752-07	12-3753-07
8	12-3752-08	12-3753-08
10	12-3752-10	12-3753-10
12	12-3752-12	12-3753-12
14	12-3752-14	12-3753-14
	17cm/6¾"	22cm/8½"

BONE SURGERY

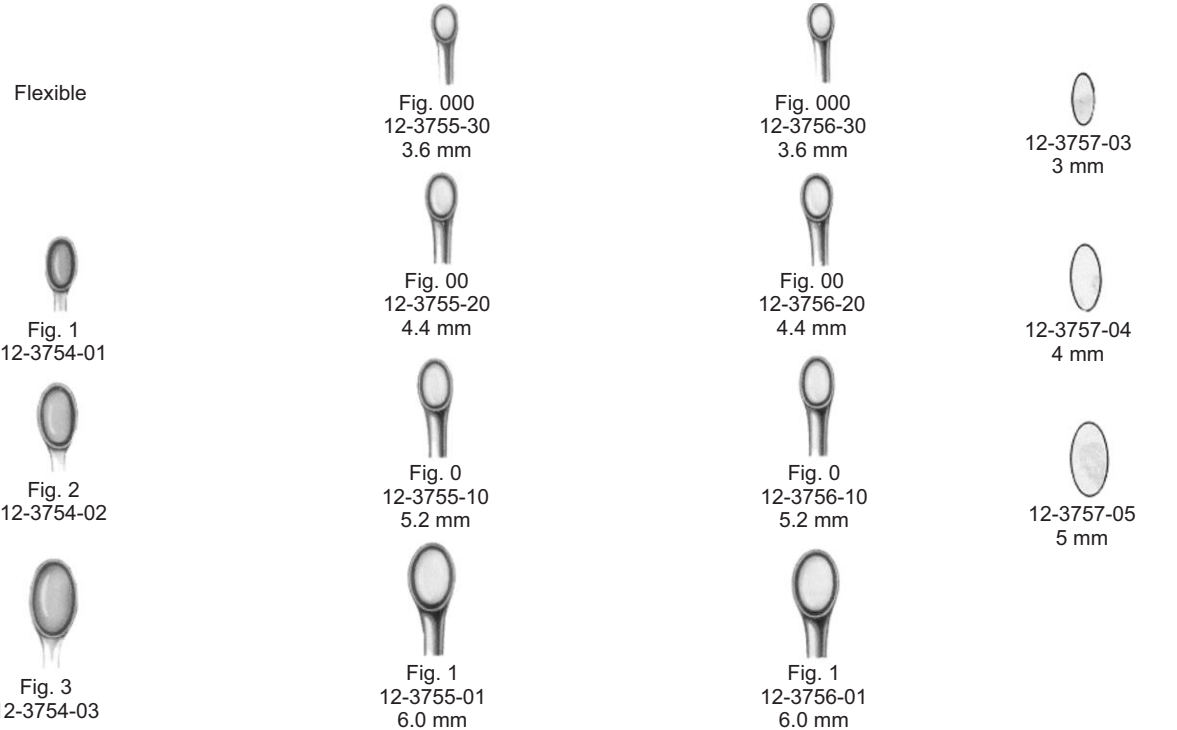

Halle
21 cm/8¼"



25 cm/10"



Bushe
25 cm/10"

BONE SURGERY

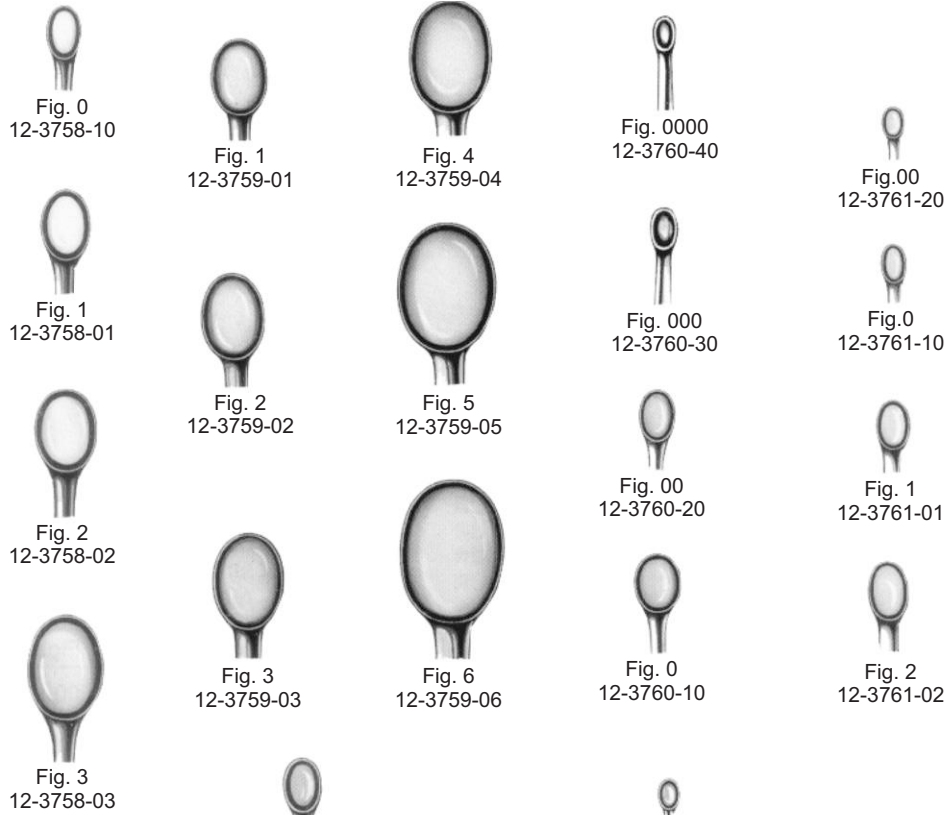

Volkmann
27 cm/10½"



Simon
24 cm/9½"



Simon
24 cm/9½"



Daubenspeck
20 cm/8"

BONE SURGERY



Martin
12-3762-19
19 cm/7½"



Preston
12-3763-18
18 cm/7¼"

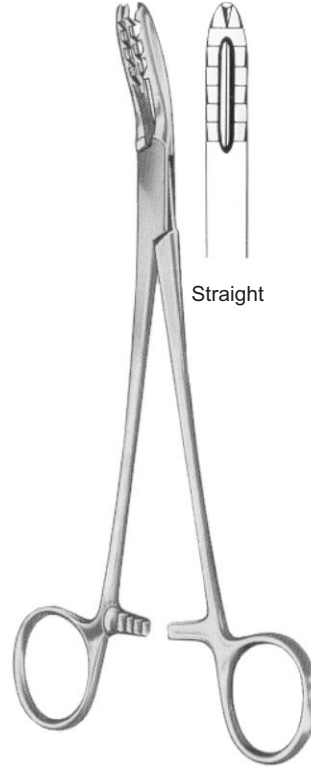

Straight

Bircher-Ganske
12-3764-20
20 cm/8"

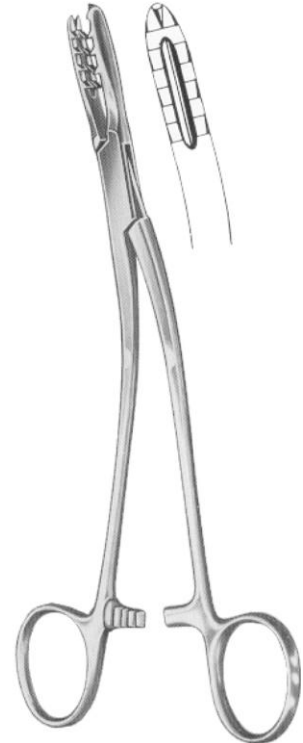

Bircher-Ganske
12-3765-20
20 cm/8"



Lewin
12-3766-17
17.5 cm/7"



Langenbeck
12-3767-21
21 cm/8¼"



Fergusson
12-3768-21
21 cm/8¼"

BONE SURGERY

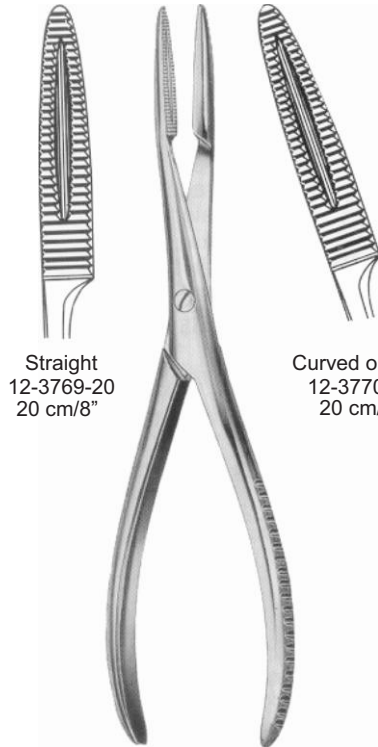

Straight
12-3769-20
20 cm/8"

Curved on Falt
12-3770-20
20 cm/8"



Van Buren
12-3771-23
23 cm/9"

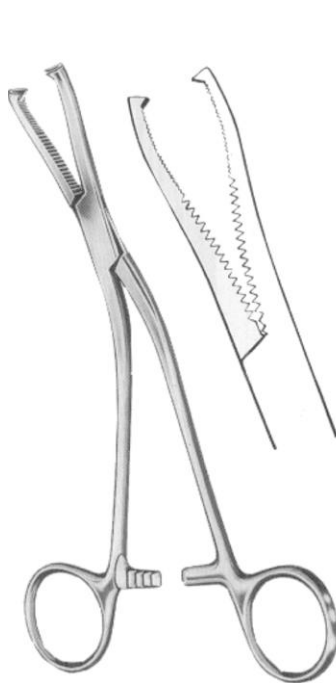

Dingmann
12-3772-19
19cm/7½"



Dingmann Modif
12-3773-19
19 cm/7½"



Neff
12-3774-21
21 cm/8¼"

BONE SURGERY



Semb
12-3775-19
19 cm/7½"



Semb
12-3776-19
19 cm/7½"



Verbrugge
12-3777-17
17.5 cm/7"

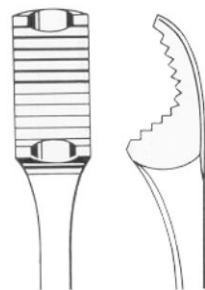

12-3778-25
25 cm/10"

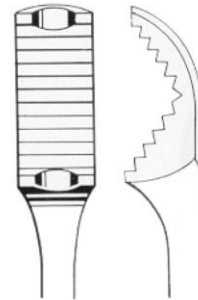

12-3779-26
26 cm/10¼"
Verbrugge

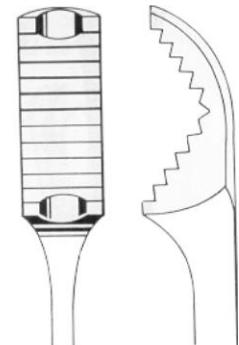

12-3780-27
27 cm/10½"

BONE SURGERY

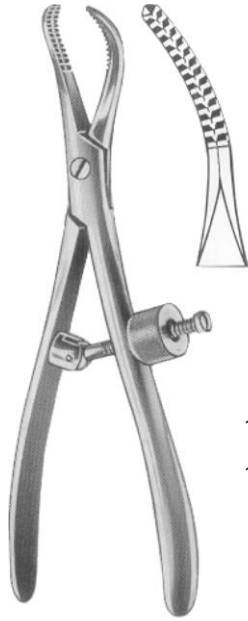

12-3781-16
 16 cm/6¼"
 12-3781-24
 24 cm/9½"



Without Ratchet	Kern		With Ratchet
	cm	in	
12-3782-17	17	6¾"	12-3783-17
12-3782-21	21	8¼"	12-3783-21



12-3784-18	18 cm/07"	12-3785-18
12-3784-23	23 cm/09"	12-3785-23
12-3784-25	25 cm/10"	12-3785-25
12-3784-28	28 cm/11"	12-3785-28



Hey Groves
 12-3786-21 21.0 cm/8¼"
 12-3786-27 27.0 cm/10½"
 12-3786-30 30.5 cm/12"

BONE SURGERY



Farabeuf-Lambotte
12-3787-26
26 cm/10¼"



Lambotte
12-3788-19 19 cm/7½"
12-3788-23 23 cm/9"
12-3788-26 26 cm/10¼"

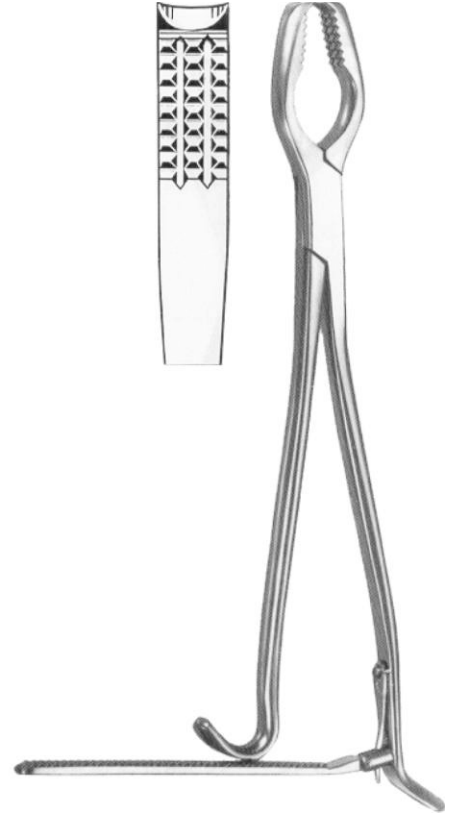

Without Ratchet	Lane	With Ratchet
	cm in	
12-3789-33	33 13"	12-3790-33
12-3789-45	45 17¾"	12-3790-45



12-3791-14
14.5 cm/5¾"



12-3792-12
12 cm/4¾"

BONE SURGERY



12-3793-15 15 cm/6"
 12-3793-19 19 cm/7 1/2"
 12-3793-24 24 cm/9 1/2"
 12-3793-26 26 cm/10 1/4"
 12-3793-28 28 cm/11"

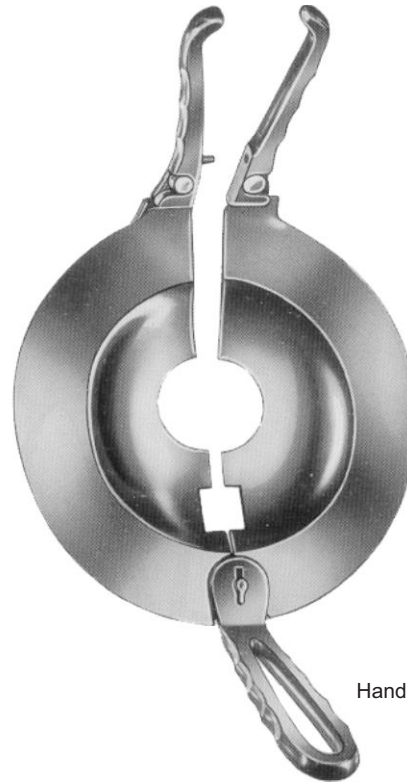

Handles Detachable

Percy
 12-3794-30

Adjustable



Lambotte
 12-3795-22 22 cm/8 3/4"
 12-3795-27 27 cm/10 1/2"
 12-3795-30 30 cm/12"



Farabeuf
 12-3796-23 23 cm/9"
 12-3796-26 26 cm/10 1/4"



Lambotte
 12-3797-22 22.5 cm/9"
 12-3797-25 25.5 cm/10 1/2"
 12-3797-33 33 cm/13 1/2"

BONE SURGERY

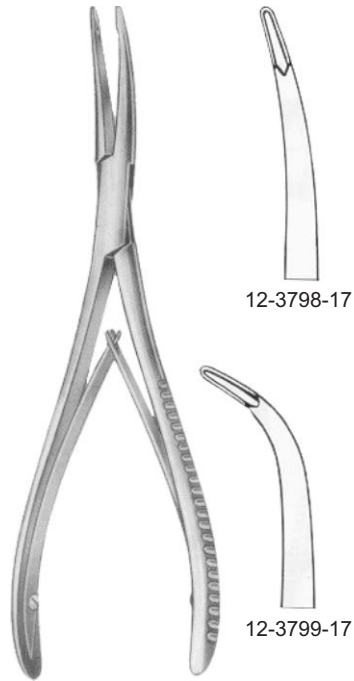

Stellbrink
17.5 cm/7"

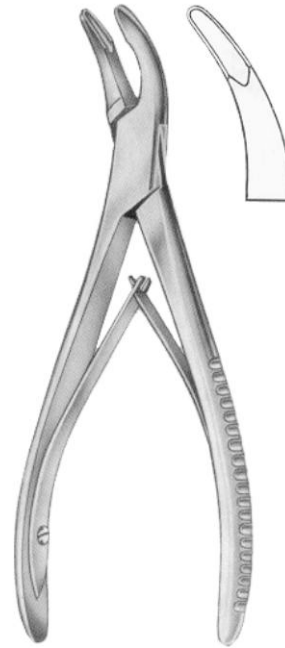

Bane-Hartmann
12-3800-17
17.5 cm/7"



Mini-Friedmann
12-3801-12
12.5 cm/5"



Friedmann
12-3802-14
14 cm/5½"

BONE SURGERY



12-3803-13
13.5 cm/5 1/4"

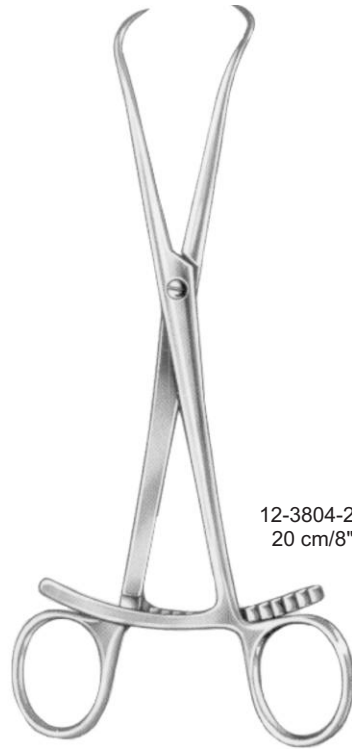

12-3804-20
20 cm/8"



12-3805-17
17 cm/6 3/4"

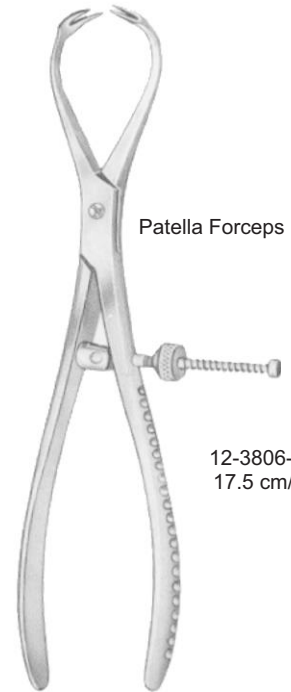

Patella Forceps

12-3806-17
17.5 cm/7"



Lowman-Hoglund
12-3807-19
19 cm/7 1/2"

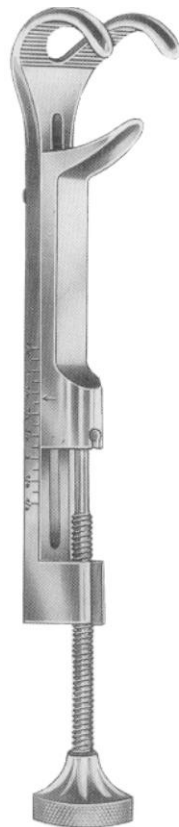

Lowman
12-3808-18 18 cm/7"
12-3808-20 20 cm/8"
12-3808-22 22 cm/8 3/4"



Lowman
12-3809-12
12 cm/4 3/4"

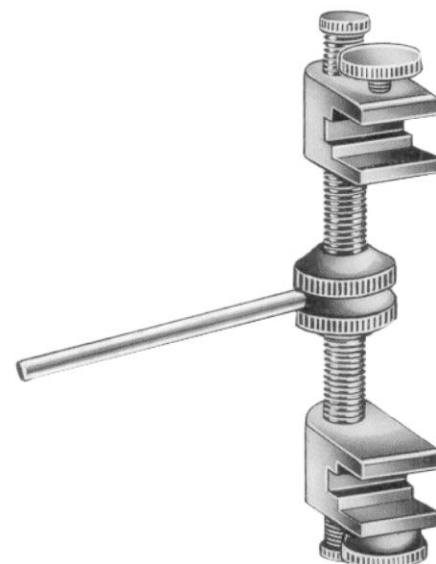

Traction Bar

12-3810-18
12-3810-50

BONE SURGERY



12-3811-16



12-3811-16A

Mead
16.5 cm/6½"



	Lempert	
Straight	cm	in
12-3812-16	16	6¼"
12-3812-19	19	7½"
	Curved	
	12-3813-16	
	12-3813-19	



Beyer
12-3814-18
18 cm/7"



12-3815-17



12-3816-17

Jansen
17.5 cm/7"



12-3817-15



12-3818-15



12-3819-15

Blumenthal
15.5 cm/6"



Hakansson
12-3820-15
15.5 cm/6"

BONE SURGERY



Friedmann-Delicate
15 cm/6"

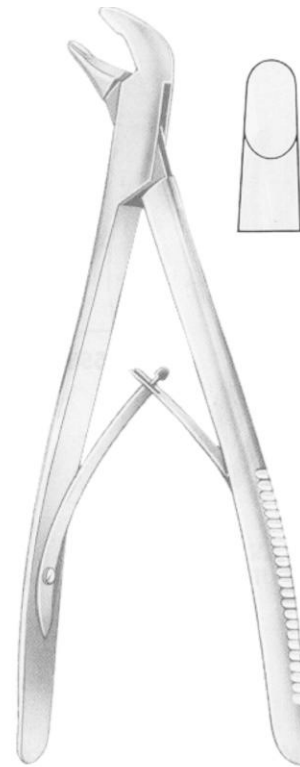

Bacon
12-3823-20
20 cm/8"

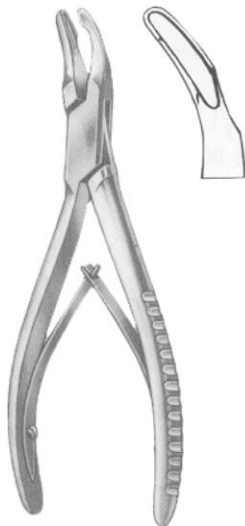

Cleveland
12-3824-14 14 cm/5½"
12-3824-17 17 cm/6¾"



Hartmann
12-3825-18
18.5 cm/7¼"



Olivecrona
12-3826-20
20 cm/8"

BONE SURGERY



Kleinert-Kutz
15 cm/6"



12-3827-15
2 mm



12-3828-15
3 mm



Bohler
15 cm/6"



12-3829-15



12-3830-15



**Beyer
Zaufal-Jansen**
18 cm/7"



Zaufal-Jansen
12-3831-18



Beyer
12-3832-18



Mayfield
12-3833-17
17 cm/6¾"



Ruskin
12-3834-18
18 cm/7"
Angled



Straight
12-3835-18
18 cm/7"
12-3835-23
23 cm/9"



Ruskin

Curved
12-3836-18
18 cm/7"
12-3836-23
23 cm/9"

BONE SURGERY



Jansen
 12-3837-18
 18 cm/7"

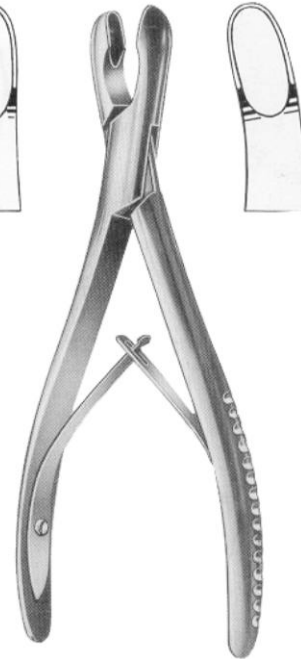

Straight
 12-3838-17

Curved
 12-3839-17

Luer
 17 cm/6¾"



Luer
 18.5 cm/7¼"

Heavy Pattern

Straight
 12-3840-18

Curved
 12-3841-18



Luer
 15 cm/6"



12-3842-15

12-3843-15

12-3844-15



Adson
 20 cm/8"

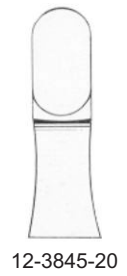

12-3845-20

BONE SURGERY



Stille-Luer
22 cm/8¾"



Straight
12-3846-22



Curved
12-3847-22



Stille-Luer
27 cm/10½"



12-3848-27



12-3849-27



Semb
12-3850-23
23 cm/9"

BONE SURGERY



Marquardt
 12-3851-20
 20 cm/8"



Rottgen-Ruskin
 12-3852-24
 24 cm/9½"



12-3853-03
 3 mm



12-3853-04
 4 mm



12-3853-05
 5 mm



12-3853-03A
 3 mm



12-3853-04A
 4 mm



12-3853-05A
 5 mm



Smith-Petersen
 24 cm/9½"

BONE SURGERY



Markwalder
12-3854-20
20 cm/8"



Straight cm
12-3855-14 14
12-3855-17 17
12-3855-19 19
12-3855-22 22



Liston in **Curved**
12-3856-14 5½
12-3856-17 6¾
12-3856-19 7½
12-3856-22 8¾



Littauer-Liston
12-3857-15
15 cm/6"



Cleveland
12-3858-15 15 cm/6"
12-3858-17 17 cm/6¾"



Bohler
15 cm/6"



McIndoe
12-3861-17
17.5 cm/7"

BONE SURGERY

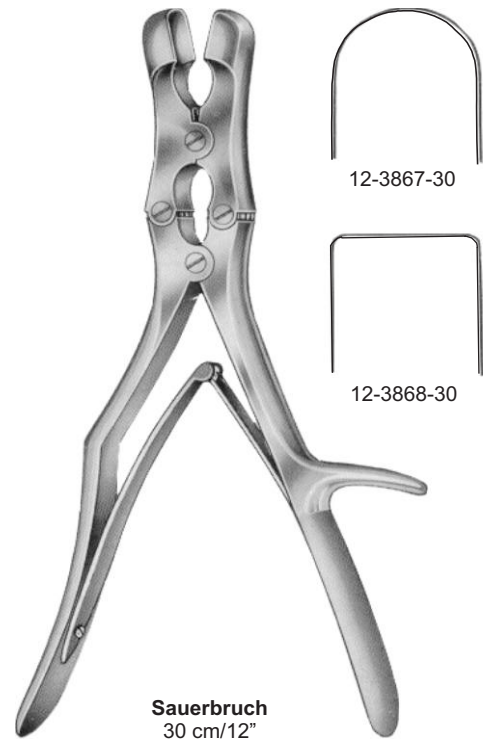
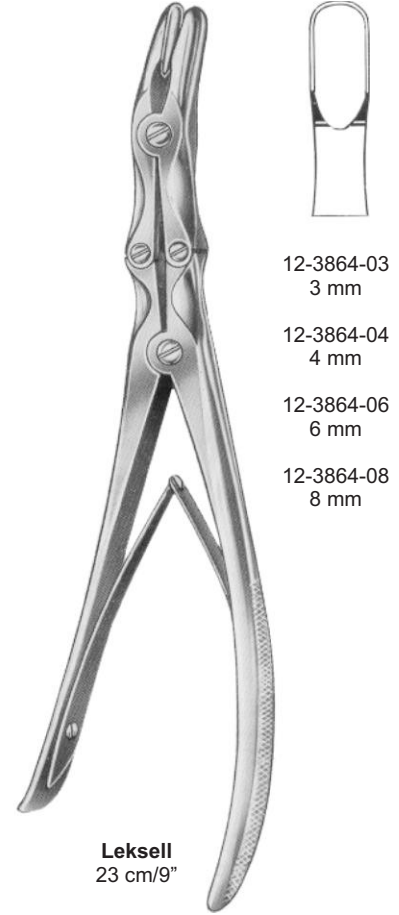
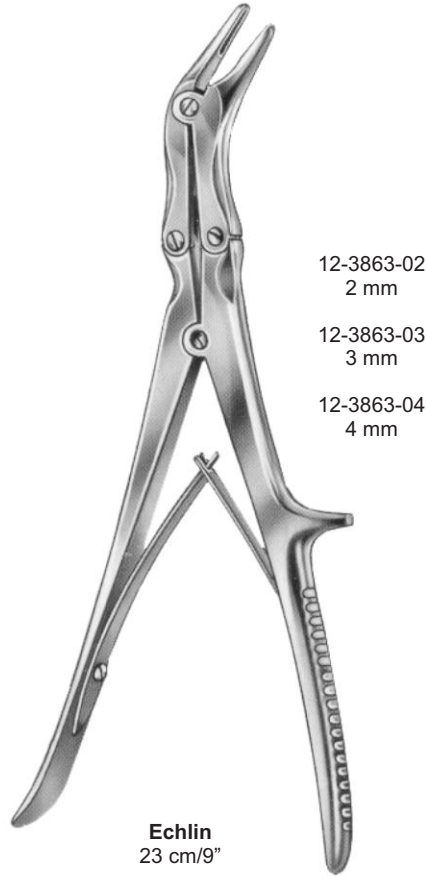

BONE SURGERY

Forceps for tearing out toe and finger nails

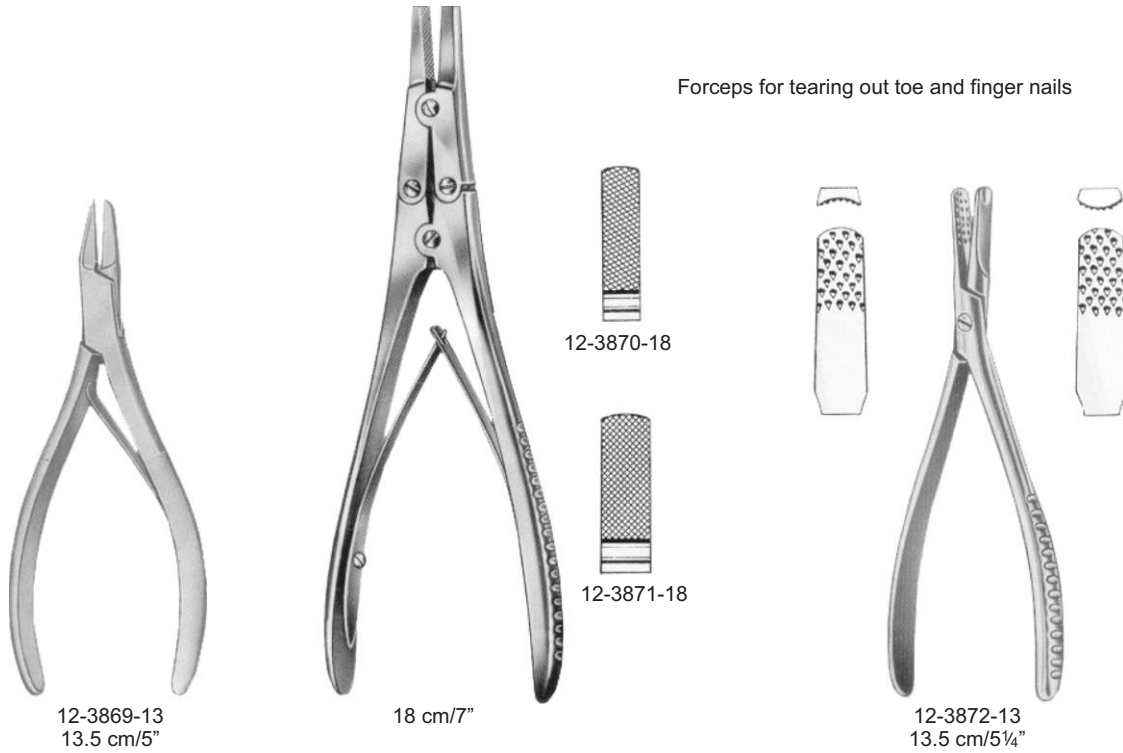

Saw blade



12-3873-17
17 cm/6¾"

Saw blade



12-3874-17
17 cm/6¾"

BONE SURGERY



Kazanjan
 12-3875-18
 18 cm/7"



Ruskin-Liston
 18.5 cm/7¼"

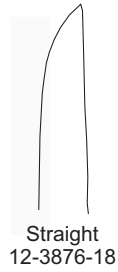

Straight
 12-3876-18

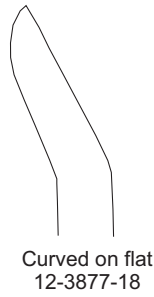

Curved on flat
 12-3877-18



Stille-Liston
 23 cm/9"
 27 cm/10½"

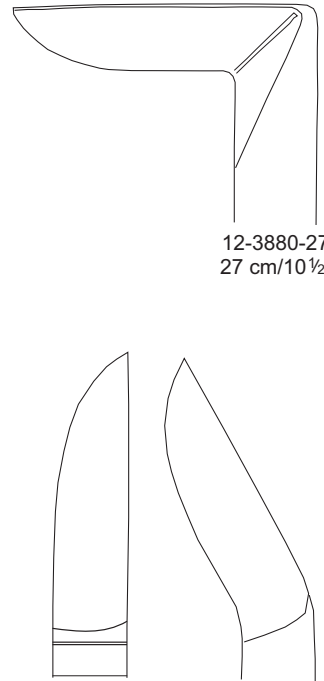

12-3880-27
 27 cm/10½"

12-3878-23
 12-3878-27

12-3879-23
 12-3879-27



Liston-Key(Horsley)
 12-3881-27
 27 cm/10½"

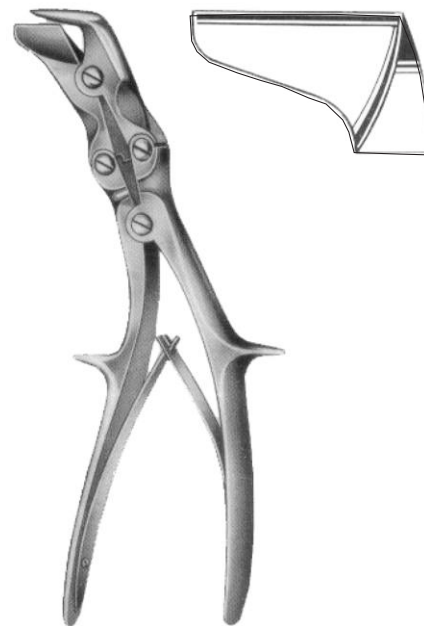

Semb
 12-3882-24
 24 cm/9½"

BONE SURGERY



12-3883-13 13 cm/5"
12-3883-18 18 cm/7"

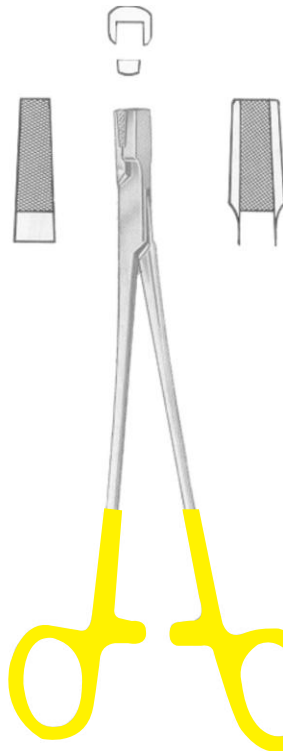

12-3884-17
17 cm/6¾"

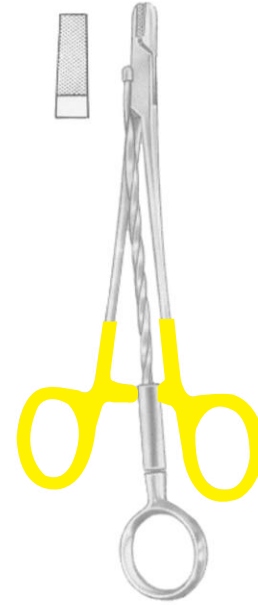

12-3885-15
15.5 cm/6"

TC



12-3886-17 17 cm/6¾" 12-3887-17

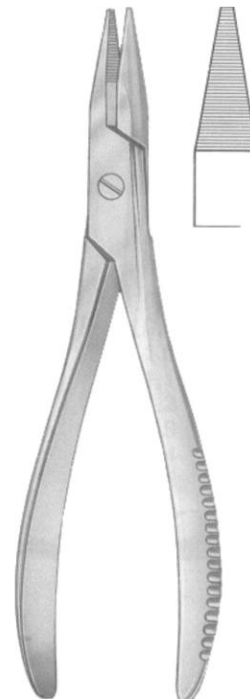

12-3888-19
19 cm/7 ½"

BONE SURGERY



12-3889-14
14 cm/5½"



12-3890-16
16 cm/6¼"



18cm/7"

TC

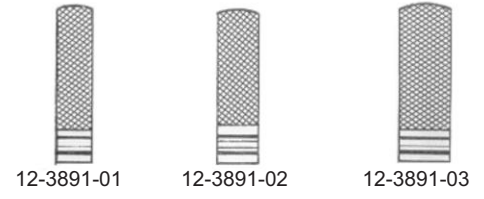

12-3891-01

12-3891-02

12-3891-03



12-3891-04

12-3891-05

TC



12-3892-18 18 cm/7"
12-3892-20 20 cm/8"

TC



12-3893-16
15 cm/6"

12-3893-20
20 cm/8"

12-3894-16
15 cm/6"

BONE SURGERY



For soft wire
with a diam. of max.

12-3895-15
15 cm/6"
2.0 mm

12-3896-18
18.5 cm/7¼"
1.7 mm

12-3897-16
16 cm/6¼"
2.0 mm

For hard wire
with a diam. of max.

1.5 mm

1.7 mm

2.0 mm

BONE SURGERY

TC



12-3898-12
 0.7 mm
 0.5 mm
 12 cm/4¾"



12-3899-15
 2.0 mm
 1.0 mm
 15 cm/6"



12-3900-18
 2.0 mm
 1.7 mm
 18 cm/7"



212-3901-18
 2.5 mm
 1.5 mm
 18.5 cm/7¼"



12-3902-18
 2.0 mm
 1.7 mm
 18 cm/7"



12-3903-22
 3.0 mm
 2.5 mm
 22 cm/8¾"



12-3904-22
 3.0 mm
 2.2 cm/8¾"

BONE SURGERY

Screw Nut Wrench



12-3905-10
10 cm/4"

Screw Driver



12-3906-12
12 cm/4 3/4"

Wire Strainer



12-3907-20
20 cm/8"

Fixation Discs For Drill Wires



12-3908-30
Pair



12-3909-40



12-3910-42

Fixation Discs



12-3911-51
Pair

BONE SURGERY



With 1 Pin

Bohler

cm	in	
h x b	h x b	For Arm
16 x 9	6¼ x 3½	12-3912-16

cm	in	
		For Thigh and Knee
21 x 11	8¼ x 4½	12-3913-21

With 3 Traction Hooks



Kirschner

Clear Width	cm	in
12-3914-01	9.5x7	3¾x2¾
12-3914-02	10.5x10.5	4¼x4¼
12-3914-03	12x12	4¾x4¾
12-3914-04	15.5x15.5	6x6
12-3914-05	20x15.5	8x6

With 3 Traction Hooks



Kirschner

12-3916-01	Small Pattern
12-3916-02	Medium Pattern
12-3916-03	Large Pattern



Clear Width

	cm	in
12-3915-18	18x10	07x04
12-3915-27	27x16	10½x06¼

BONE SURGERY



7 mm Ø



Spare Screw

12-3917-34
34cm/13½"

Tendon Passing Instruments



Malleable

Bunnell
12-3918-18 18cm/7"
12-3918-23 23cm/9"

Tendon Strippers



mm Ø
4.0 12-3919-40
4.5 12-3919-45
5.5 12-3919-55
Flexible Shaft

Bunnell
23cm/9"



Fischer
12-3920-31
31 cm/12¼"



Brand



12-3921-50
50 cm/19½"
06 mm Ø



12-3922-30
30 cm/12"
03 mm Ø



Brand
12-3923-50
50 cm/19½"

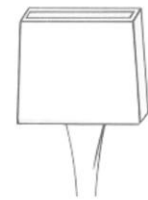

6 x 14 mm

BONE SURGERY

Bone Wire Guides



Bone Wire Tighteners

Loute
 12-3924-00
 21 cm/8¼"



Bone Wire Guides
 Fig. 1 12-3925-01
 Fig. 2 12-3925-02
 Fig. 3 12-3925-03

Demel

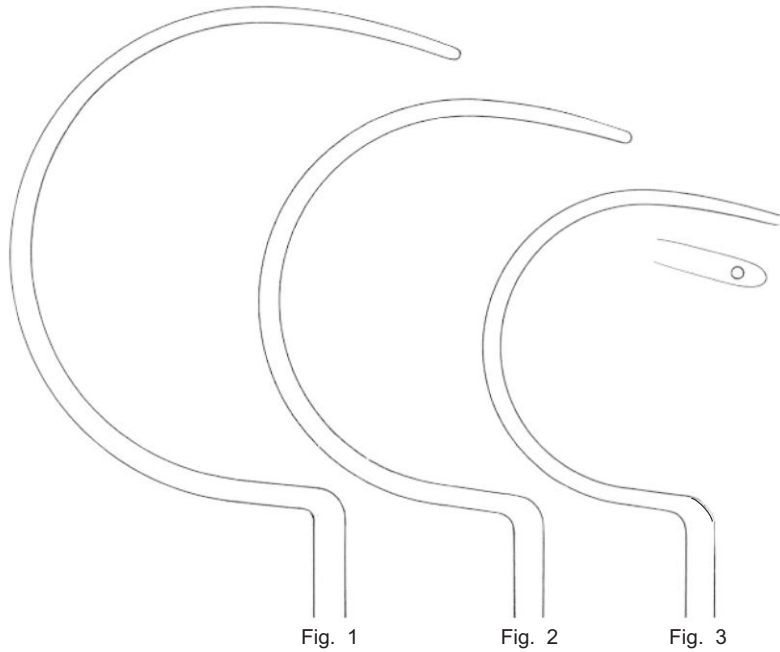

BONE SURGERY

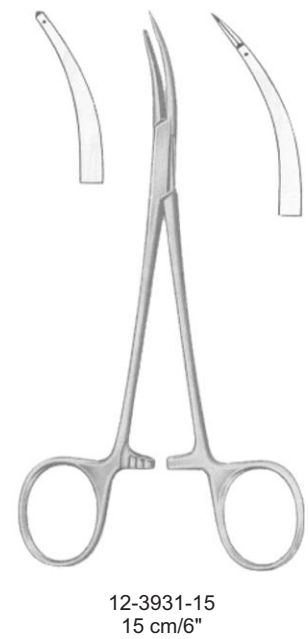
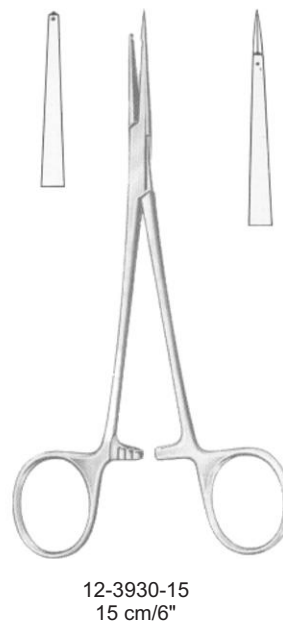
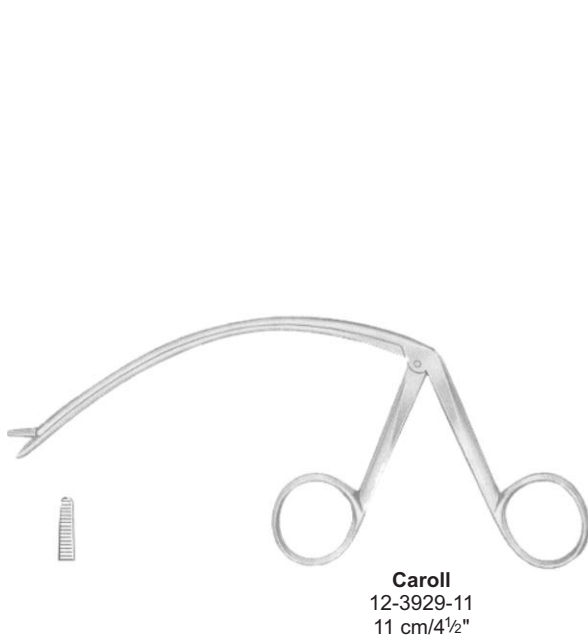
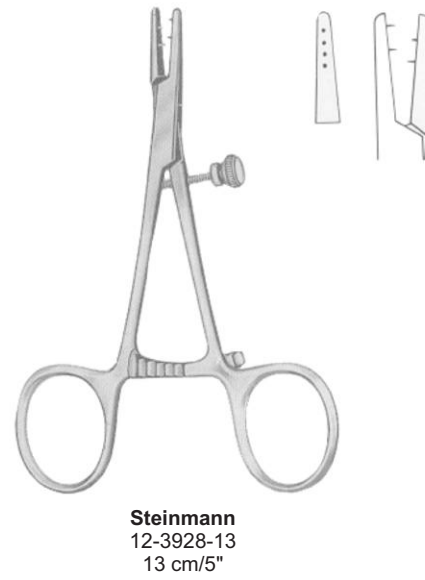
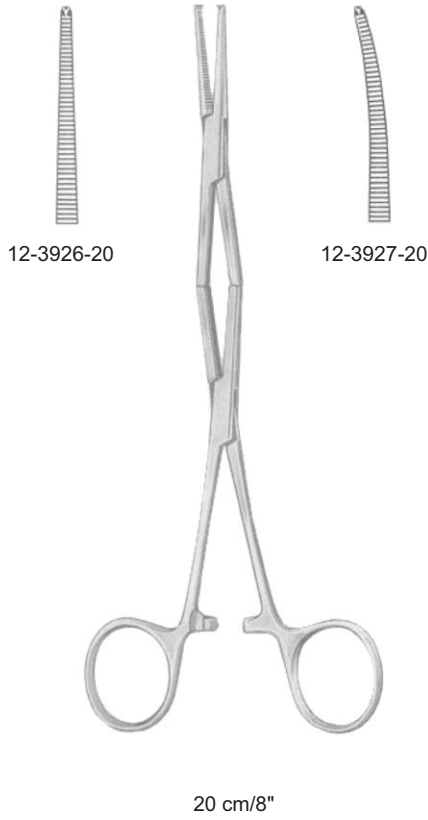

BONE SURGERY



Steinmann
 12-3932-16
 16 cm/6¼"



12-3933-02
 2 mm

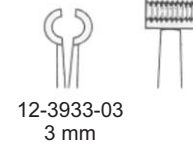

12-3933-03
 3 mm



Larsen
 10 cm/4"

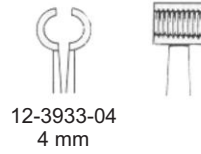

12-3933-04
 4 mm

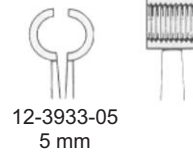

12-3933-05
 5 mm



Kleinert-Kutz
 12-3934-20
 20 cm/8"



Brand
 12-3935-15 15 cm/6"
 12-3935-19 19 cm/7½"
 12-3935-24 24 cm/9½"

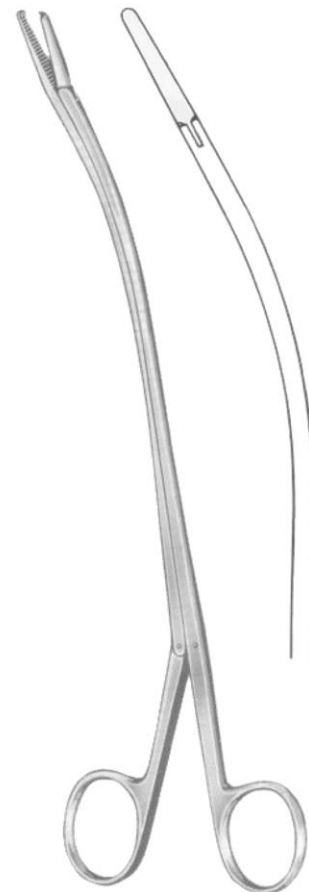

Brand
 12-3936-15 15 cm/6"
 12-3936-19 19 cm/7½"
 12-3936-24 24 cm/9½"

- EN** Plaster Instruments
- DE** Plaster Instrumente
- ES** Instrumentos de yeso

Page 315 to 317



PLASTER

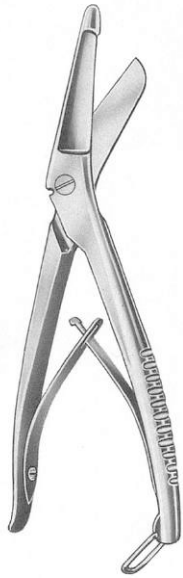

13-4001-20 20.0cm



Seutin
13-4002-23 23.0cm



Brun's
13-4003-24 24.0cm



Brun's (serrated)
13-4004-24 24.0cm



Stille-Mini
13-4005-20 20.0cm



Stille
13-4006-20 20.0cm
13-4006-23 23.0cm
13-4006-26 26.0cm
13-4006-30 30.0cm
13-4006-37 37.0cm



Stille
13-4007-24 24.0cm

PLASTER

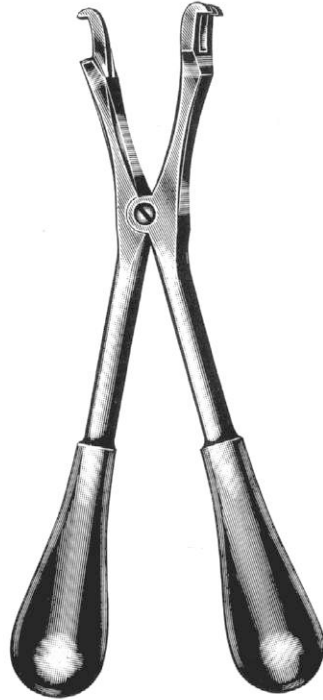

Haglund-Stille
13-4008-28 28.0cm



USA Mod Spreader
13-4009-23 23.0cm



Wolff-Boehler
13-4010-18 18.0cm
13-4010-20 20.0cm
13-4010-22 22.0cm
13-4010-24 24.0cm
13-4010-26 26.0cm



Hennig
13-4011-28
28.0cm



Beeson
13-4012-30
30.0cm

PLASTER



Bergmann
13-4013-18 18.0cm



Engel
13-4014-14 14.0cm



Hopkins
13-4015-20 20.0cm



Esmarch
13-4016-18 18.0cm

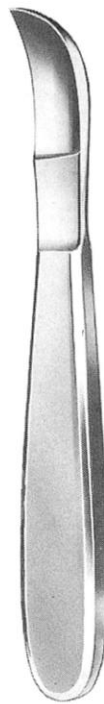

Reiner
13-4017-18 18.0cm



13-4018-21 21.0cm



Wigmor
13-4019-19 19.0cm

- EN** Cardiovascular Surgery
- DE** Herz- und Gefäßchirurgie
- ES** Cirugía cardiovascular

Page 318 to 357

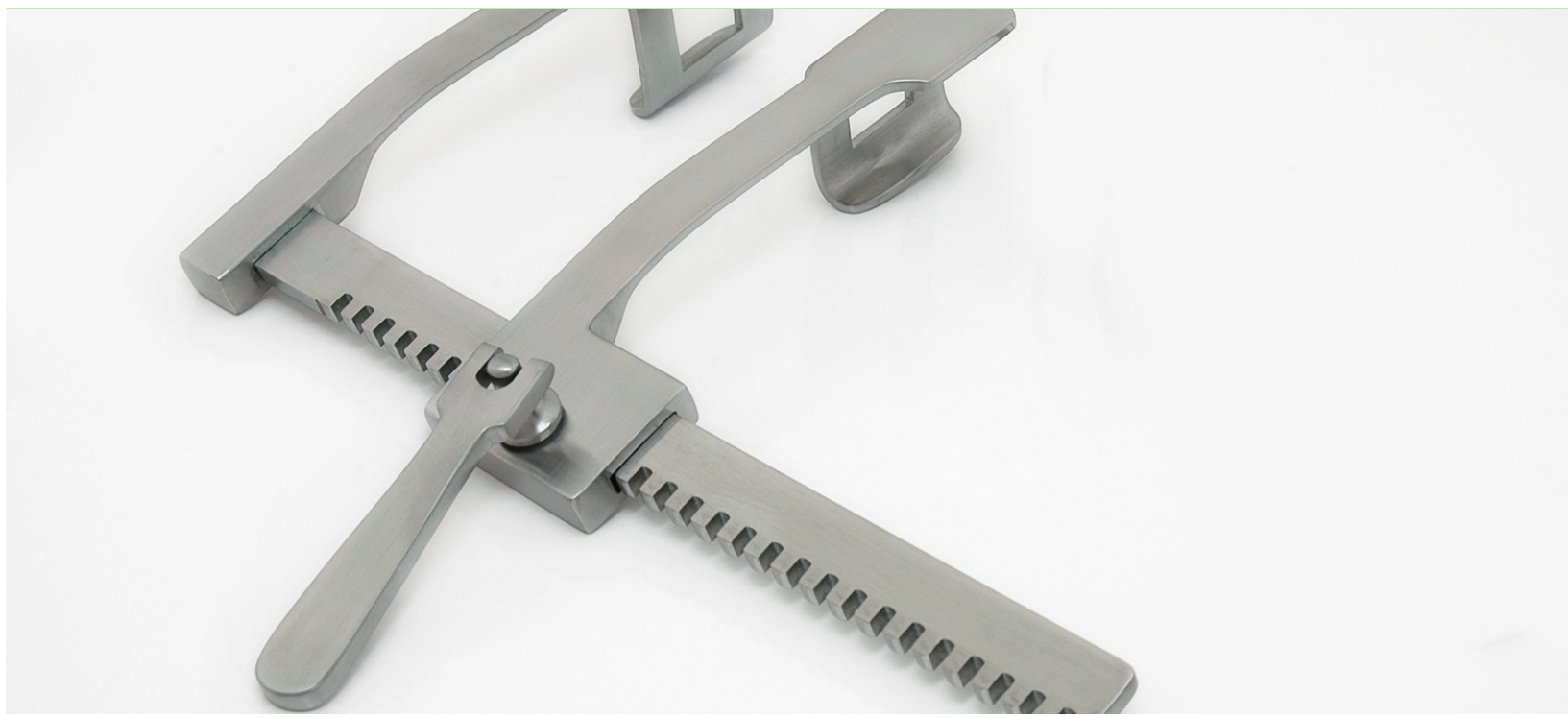

CARDIOVASCULAR

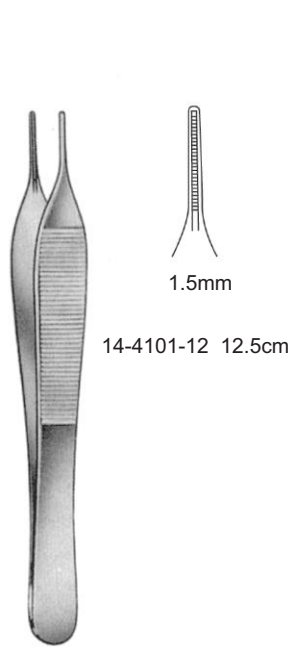

1.5mm
14-4101-12 12.5cm

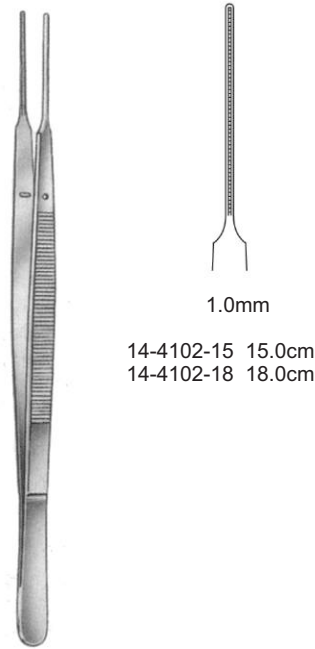

1.0mm
14-4102-15 15.0cm
14-4102-18 18.0cm

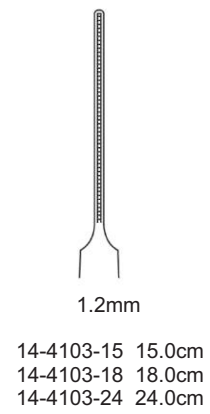

1.2mm
14-4103-15 15.0cm
14-4103-18 18.0cm
14-4103-24 24.0cm

DEBAKEY-ADSON

DEBAKEY-GERALD

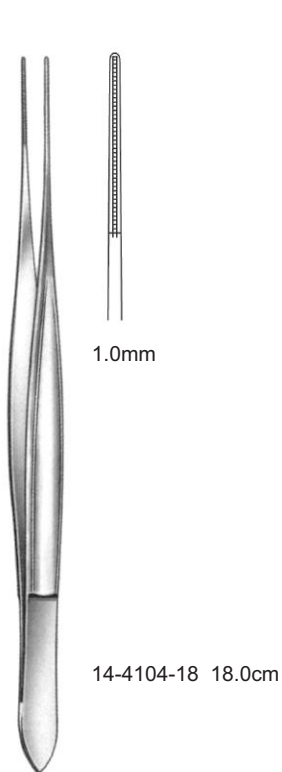

1.0mm
14-4104-18 18.0cm

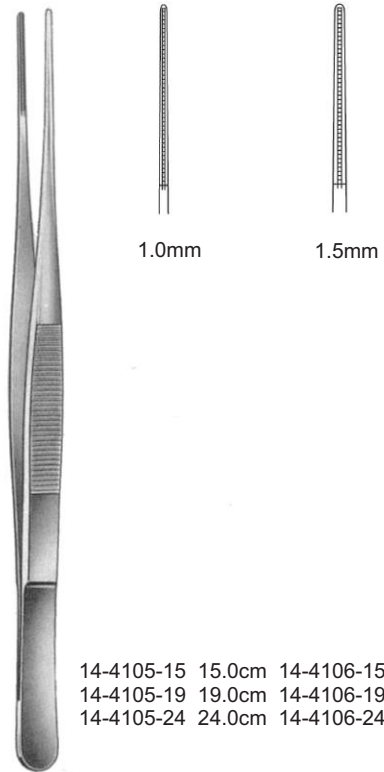

1.0mm 1.5mm
14-4105-15 15.0cm 14-4106-15
14-4105-19 19.0cm 14-4106-19
14-4105-24 24.0cm 14-4106-24



1.0mm
14-4107-15 15.0cm
14-4107-19 19.0cm
14-4107-24 24.0cm

DEBAKEY-CUSHING

DEBAKEY-DIETRICH

DEBAKEY-LIGHT

CARDIOVASCULAR

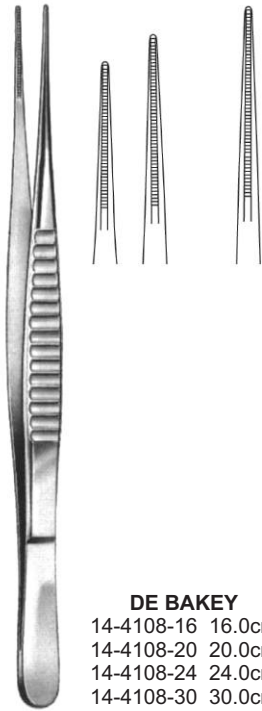

DE BAKEY
 14-4108-16 16.0cm
 14-4108-20 20.0cm
 14-4108-24 24.0cm
 14-4108-30 30.0cm

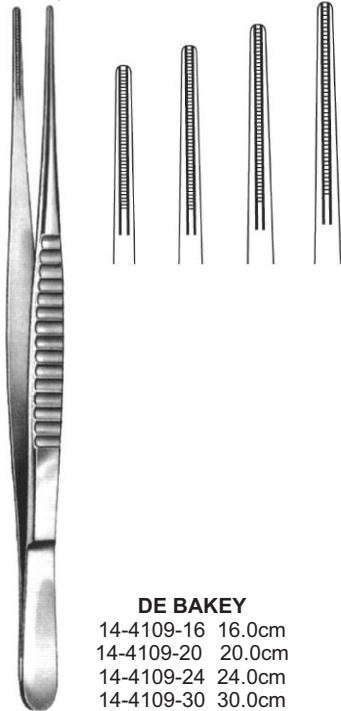

DE BAKEY
 14-4109-16 16.0cm
 14-4109-20 20.0cm
 14-4109-24 24.0cm
 14-4109-30 30.0cm

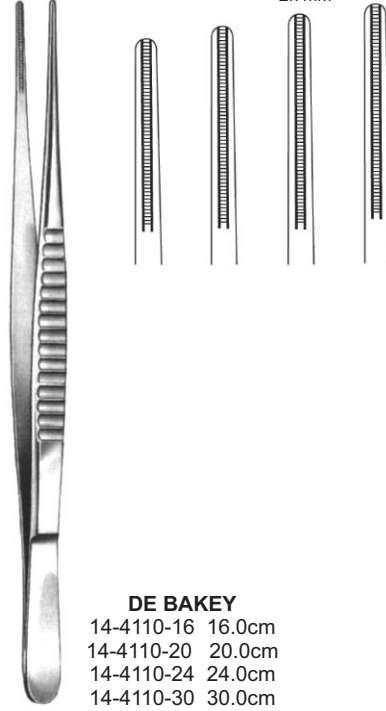

DE BAKEY
 14-4110-16 16.0cm
 14-4110-20 20.0cm
 14-4110-24 24.0cm
 14-4110-30 30.0cm

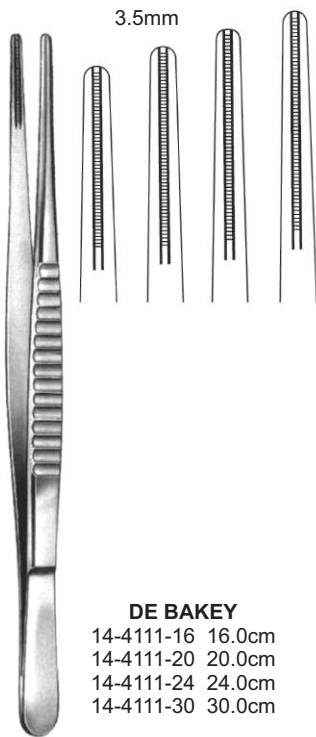

DE BAKEY
 14-4111-16 16.0cm
 14-4111-20 20.0cm
 14-4111-24 24.0cm
 14-4111-30 30.0cm

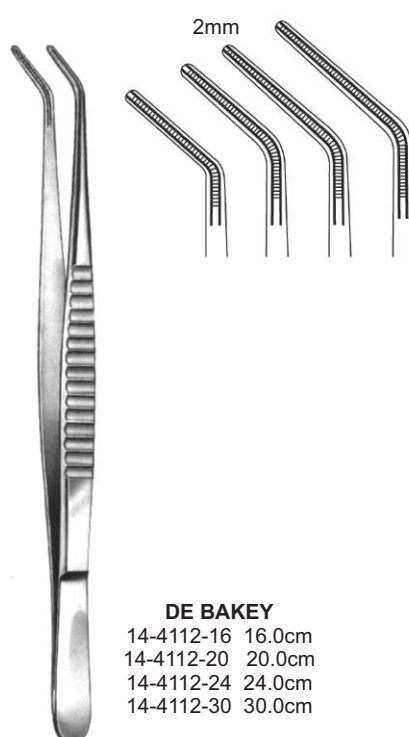

DE BAKEY
 14-4112-16 16.0cm
 14-4112-20 20.0cm
 14-4112-24 24.0cm
 14-4112-30 30.0cm



DE BAKEY
 14-4114-16 16.0cm
 14-4114-20 20.0cm
 14-4114-24 24.0cm
 14-4114-30 30.0cm

CARDIOVASCULAR

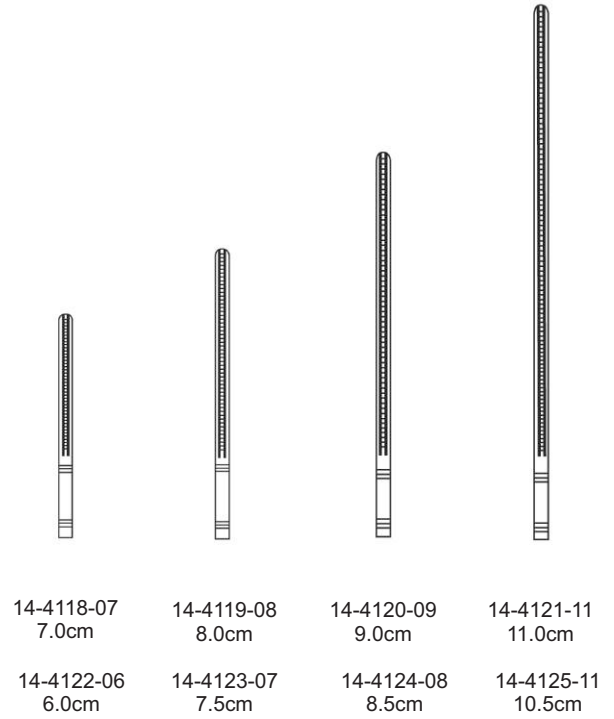
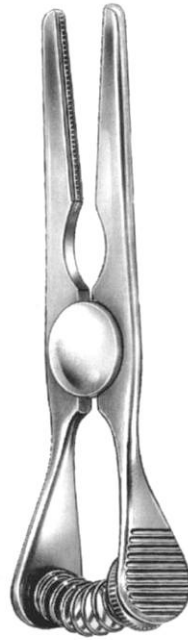
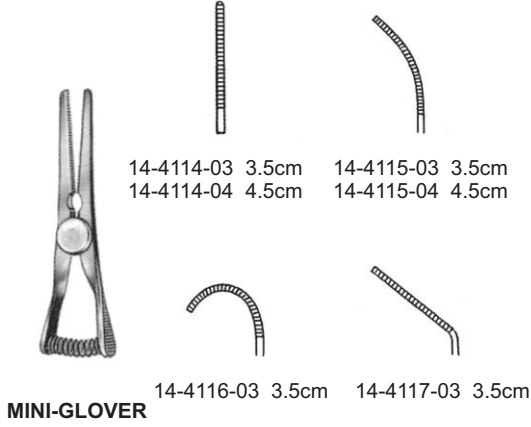

14-4126-05 5.0cm

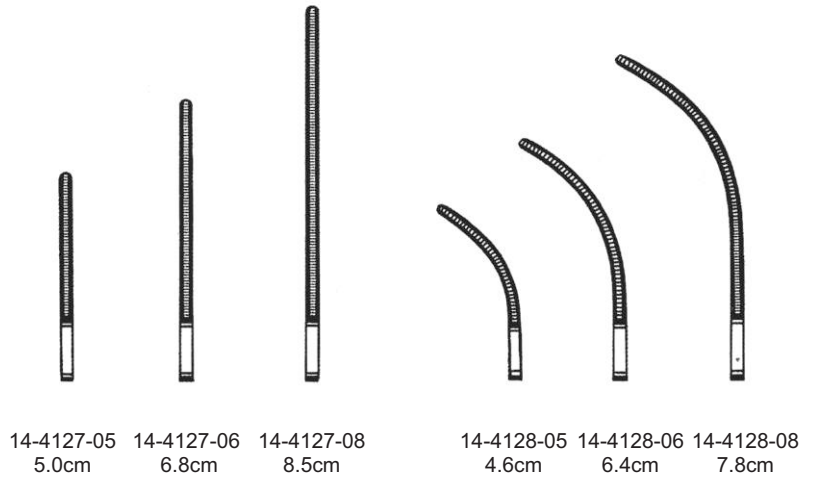
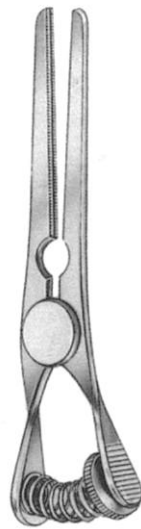

CARDIOVASCULAR



DE BAKEY

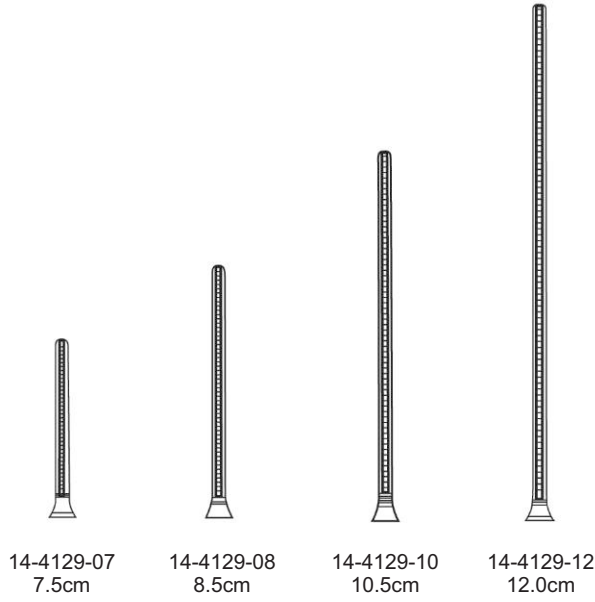

14-4129-07
7.5cm

14-4129-08
8.5cm

14-4129-10
10.5cm

14-4129-12
12.0cm



DE BAKEY

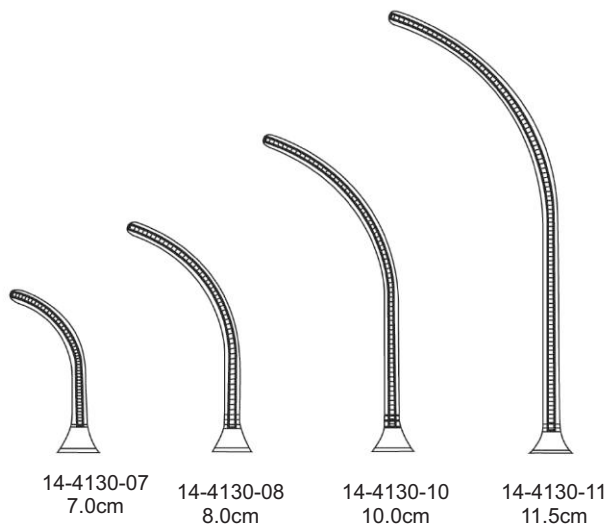

14-4130-07
7.0cm

14-4130-08
8.0cm

14-4130-10
10.0cm

14-4130-11
11.5cm

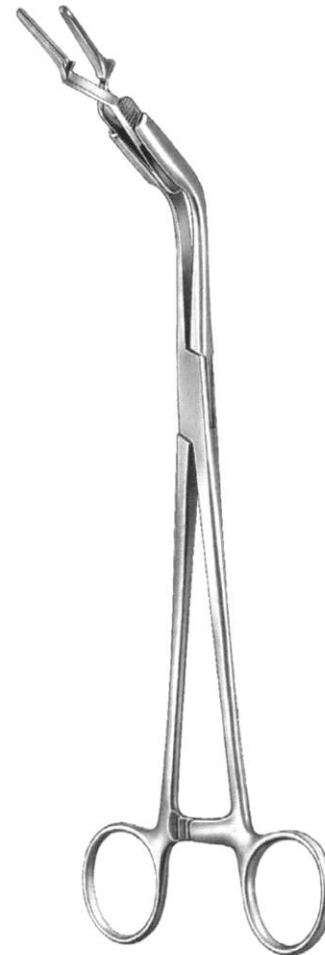

14-4131-23 23.0cm

CARDIOVASCULAR

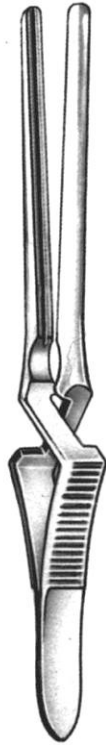

GREGORY SOFT

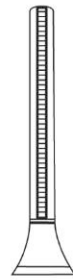

14-4132-09
9.0cm

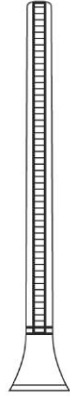

14-4132-11
11.0cm



GREGORY SOFT

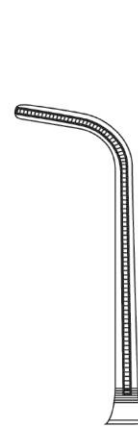

14-4133-09
9.0cm

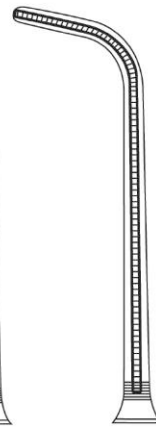

14-4133-11
11.0cm



GREGORY SOFT
11.0cm



14-4134-01

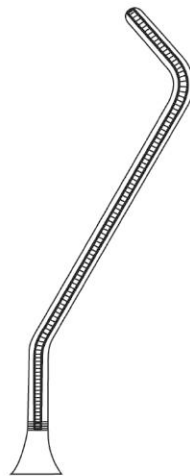

14-4134-02



SANTULLI
14-4135-07 7.0cm

CARDIOVASCULAR



DE BAKEY-SATINSKY
 14-4136-07 7.0cm

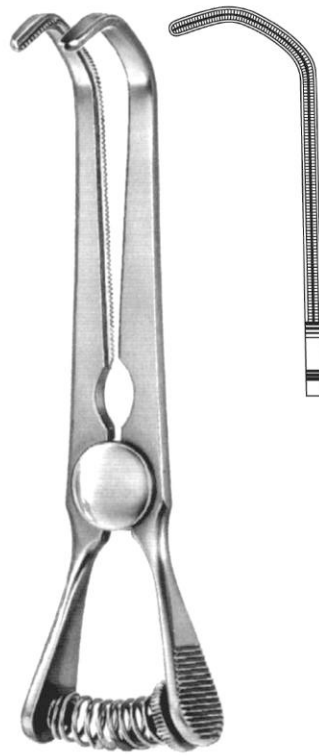

DE BAKEY-SATINSKY
 14-4137-10 10.0cm

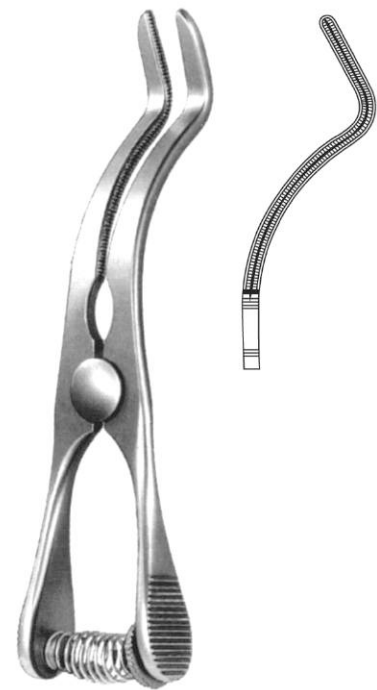

DE BAKEY-CAROTIS
 14-4138-09 9.0cm

CARDIOVASCULAR



De Bakey

Coarctation Clamps



14-4139-21
21 cm/8¼"



14-4139-22
22 cm/8¾"



14-4140-21
21 cm/8¼"



14-4140-22
22 cm/8¾"

**Potts
(De Bakey)**



14-4141-21
21 cm/8¼"



14-4141-22
22 cm/8¾"

**Potts
(De Bakey)**



De Bakey

Anastomosis Clamps

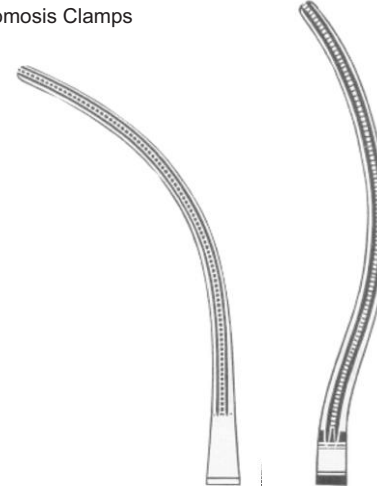

14-4142-21
21 cm/8¼"

14-4142-22
22 cm/8¾"

Potts

**Glover
(Potts)**

CARDIOVASCULAR

Dissecting and
Ligature Forceps



De Bakey



14-4143-20
20 cm/8"



14-4143-24
24 cm/9½"



De Bakey

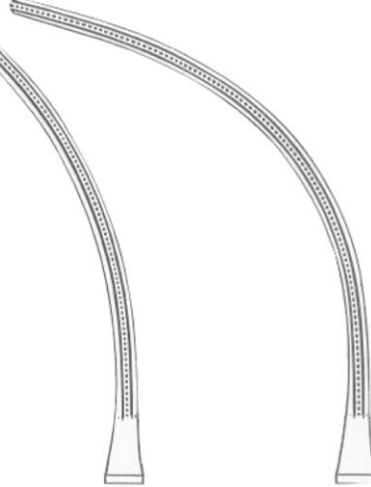

14-4144-20
20 cm/8"



14-4144-18
18 cm/7½"



De Bakey



Leland-Jones



14-4145-01
19.5 cm/7½"

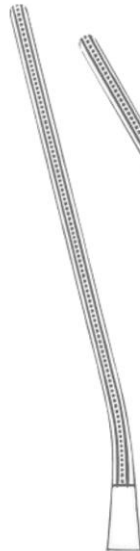

14-4145-02
19.5 cm/7½"

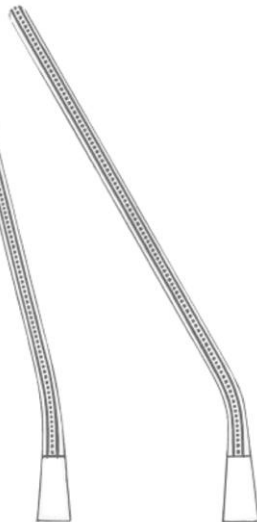

14-4145-03
19.5 cm/7½"

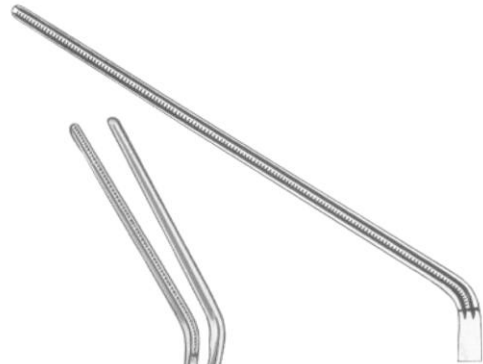

Leland-Jones
14-4146-18
18 cm/7"



CARDIOVASCULAR

Aortic Aneurysm Clamps



De Bakey



De Bakey



14-4147-24
24 cm/9½"



14-4147-27
27 cm/10½"

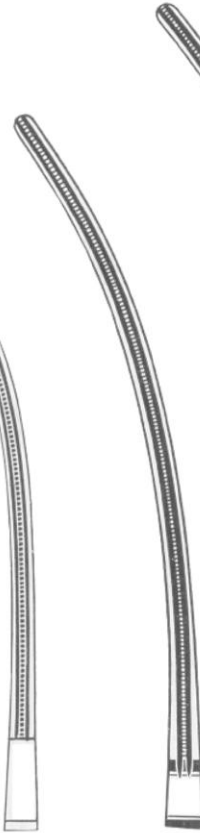

14-4147-31
31 cm/12¼"



14-4147-33
33.5 cm/13¼"



De Bakey-Bainbirdge



14-4148-15
15 cm/6"



14-4148-18
18 cm/7"



14-4148-15
15 cm/6"



14-4148-18
18 cm/7"



De Bakey
14-4149-20
20 cm/8"



CARDIOVASCULAR



De Bakey

Aortic Aneurysm Clamps

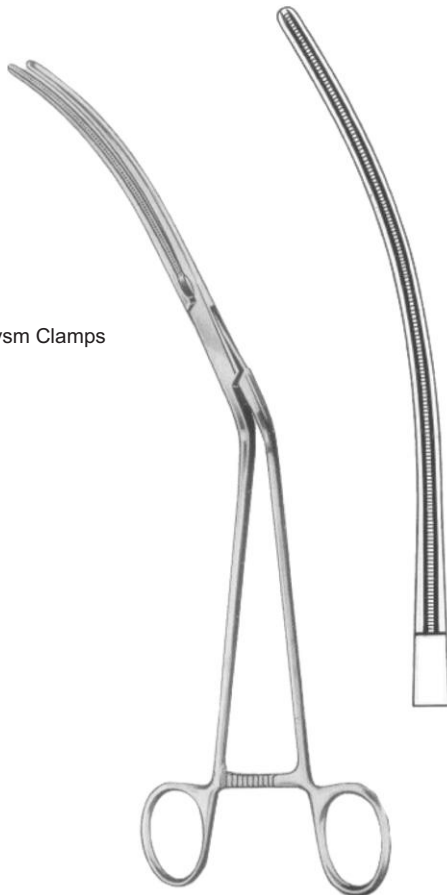

De Bakey
 14-4150-28
 28 cm/11"

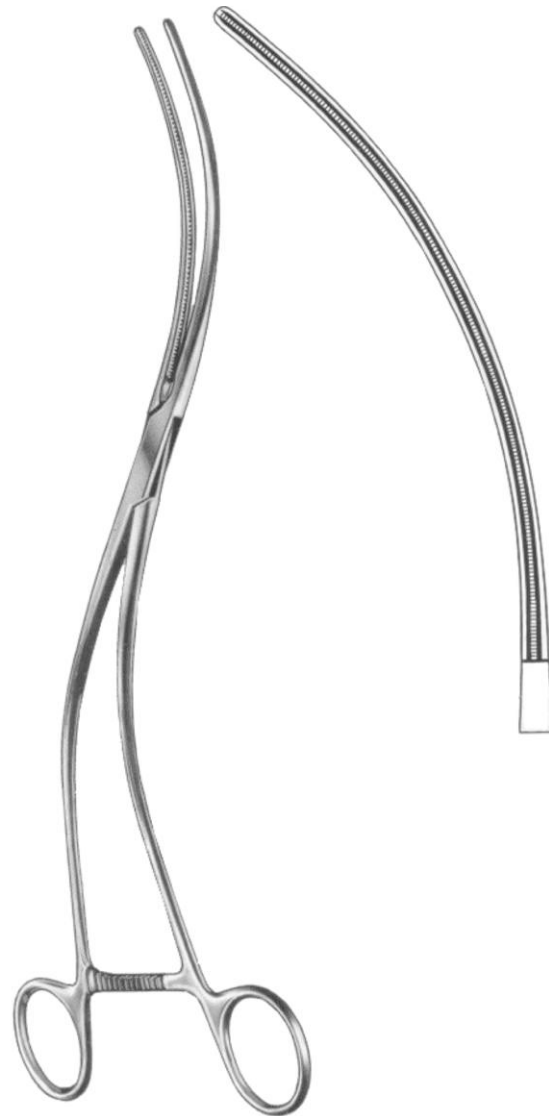

14-4151-30
 30 cm/12"

CARDIOVASCULAR



De Bakey

Aortic Clamps

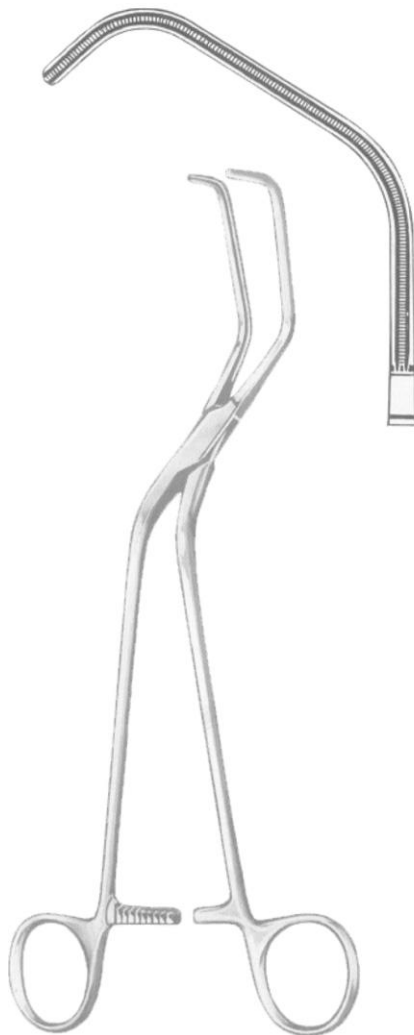

Ochsner
14-4152-23
23.5 cm/9¼"

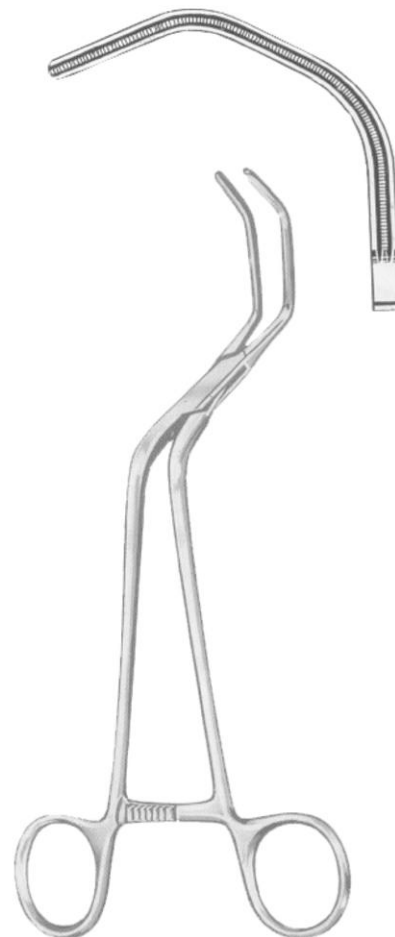

Dietrich
14-4153-21
21 cm/8¼"

CARDIOVASCULAR



De Bakey



14-4154-01
24 cm/9½"



14-4155-02
24 cm/9½"

Auricle Clamp



Harken



14-4156-03
24 cm/9½"



14-4157-04
24 cm/9½"

CARDIOVASCULAR



De Bakey

Bronchus Clamps

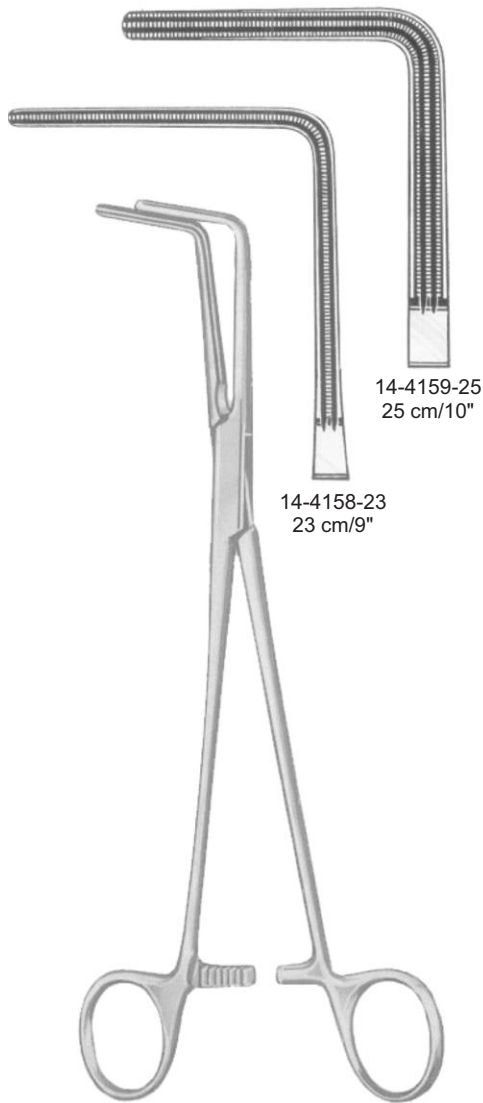

Lees

14-4159-25
25 cm/10"

14-4158-23
23 cm/9"



Lees
14-4160-25
25 cm/10"

CARDIOVASCULAR



De Bakey

Aortic Clamp

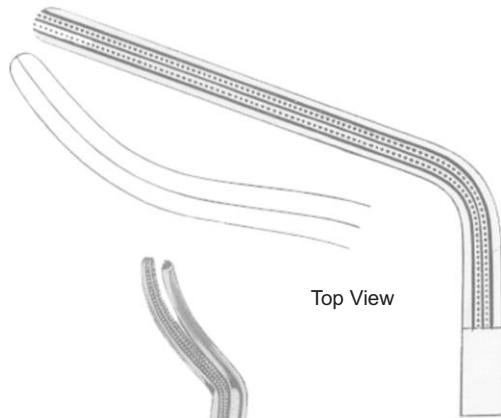

Top View



De Bakey
 14-4161-27
 27 cm/10½"

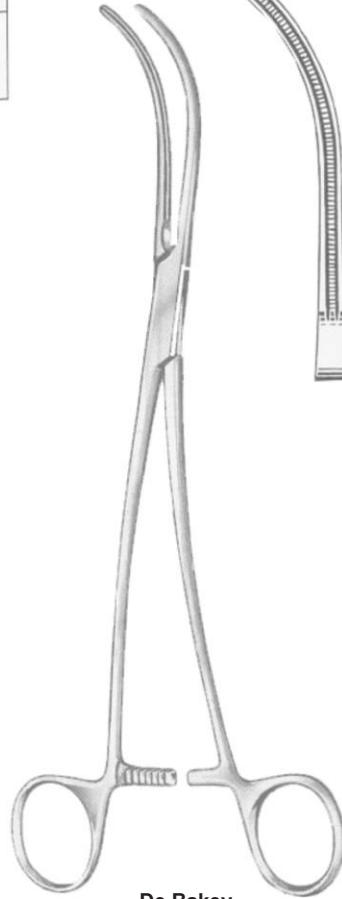

De Bakey
 14-4162-24
 24 cm/9½"

Ligature Clamps



De Bakey
 14-4163-24
 24 cm/9½"

CARDIOVASCULAR



De Bakey

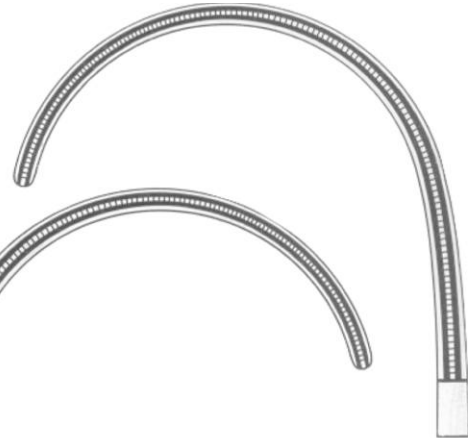

14-4167-02

14-4166-01

Ligature clamp,
Aortic clamp



De Bakey
14-4165-26
26.5 cm/10½"

De Bakey-Semb
14-4164-25
25 cm/10"

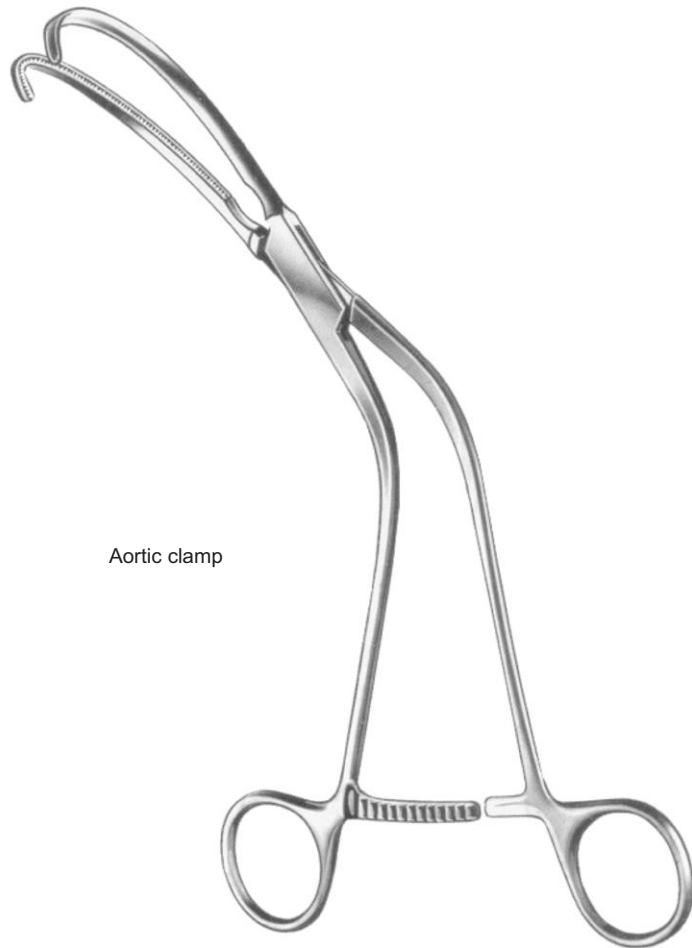

Aortic clamp



De Bakey-Semb

Weber
26 cm/10¼"

CARDIOVASCULAR



Satinsky/De Bakey

Tangential occlusion clamps



De Bakey

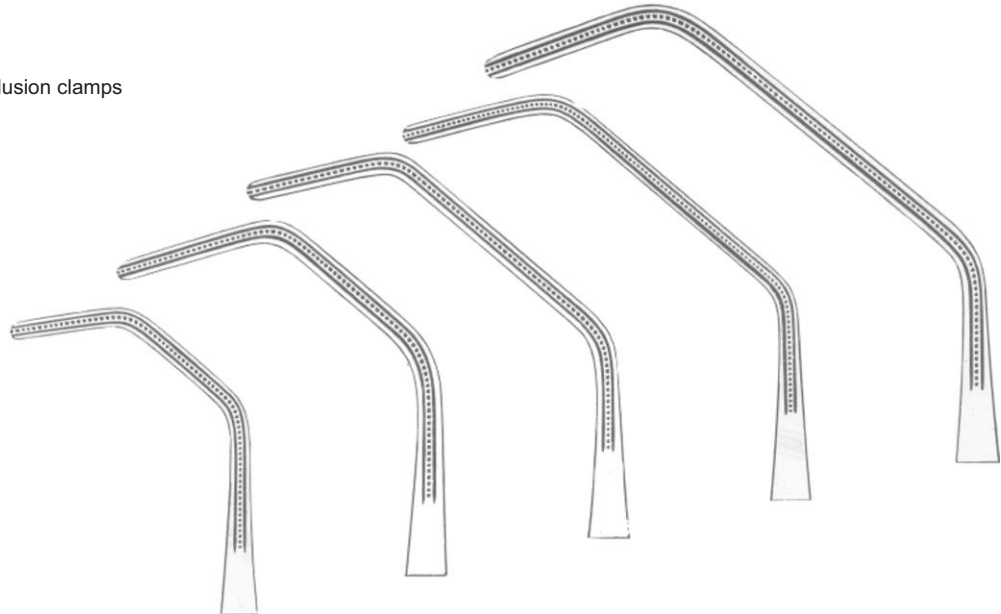

Set of 5 purchase.
14-4168-00

14-4168-20
20 cm/8"

14-4168-25
25 cm/10"

14-4168-26
26 cm/10¼"

14-4168-27
27 cm/10½"

14-4168-28
28 cm/11"



Glover

14-4169-01 19.5 cm/7¾"
 14-4169-02 21.0 cm/8¼"

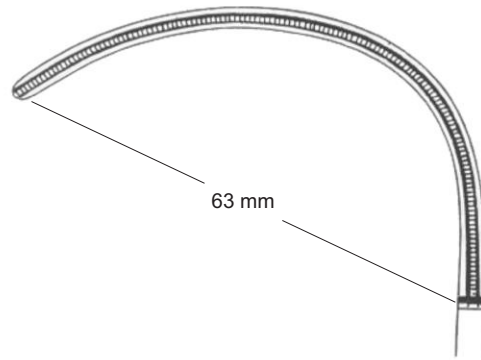

Anastomosis

63 mm

14-4169-01

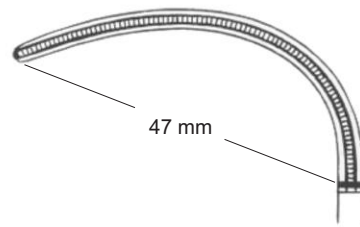

47 mm

14-4169-02

CARDIOVASCULAR



De Bakey



De Bakey
14-4170-16
16 cm/6 1/4"

Graduated

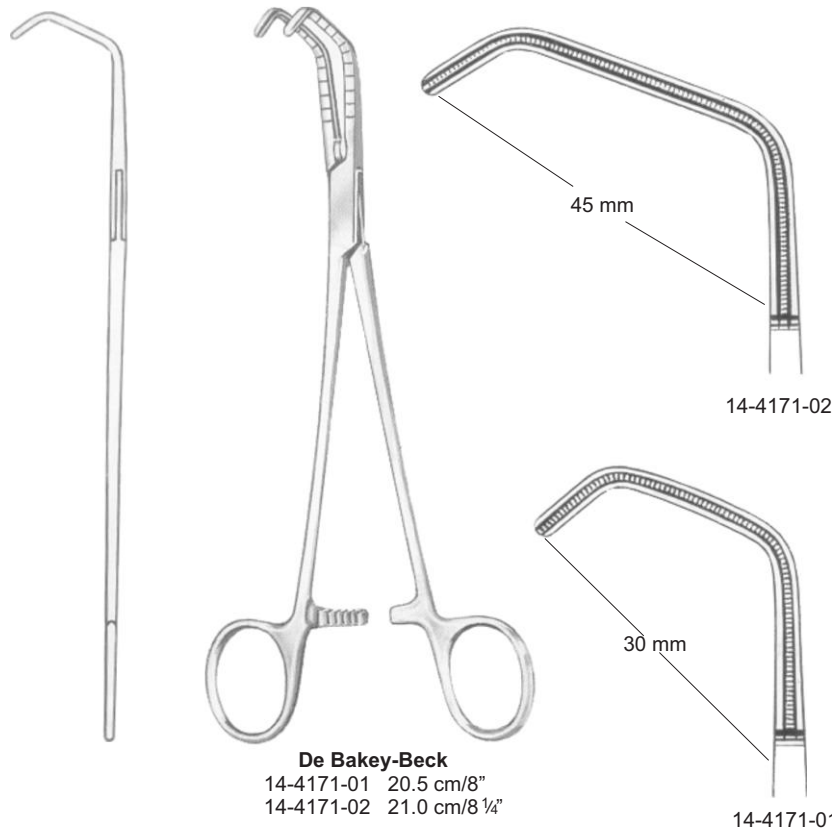

De Bakey-Beck
14-4171-01 20.5 cm/8"
14-4171-02 21.0 cm/8 1/4"

CARDIOVASCULAR



De Bakey



Lambert-Kay
21 cm/8¼"



Aortic anastomosis clamps

14-4172-21

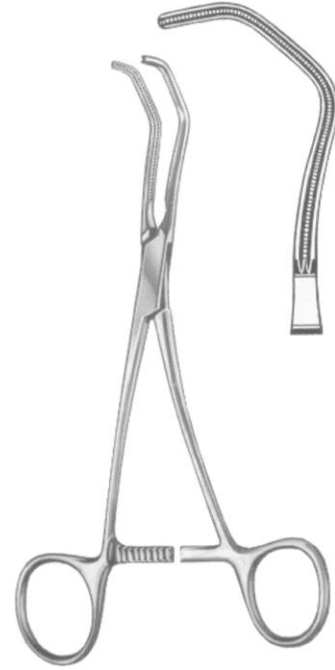

De Bakey
14-4173-17
17 cm/6¾"



Beck
14-4174-17
17 cm/6¾"

CARDIOVASCULAR



De Bakey



Multi purpose clamps

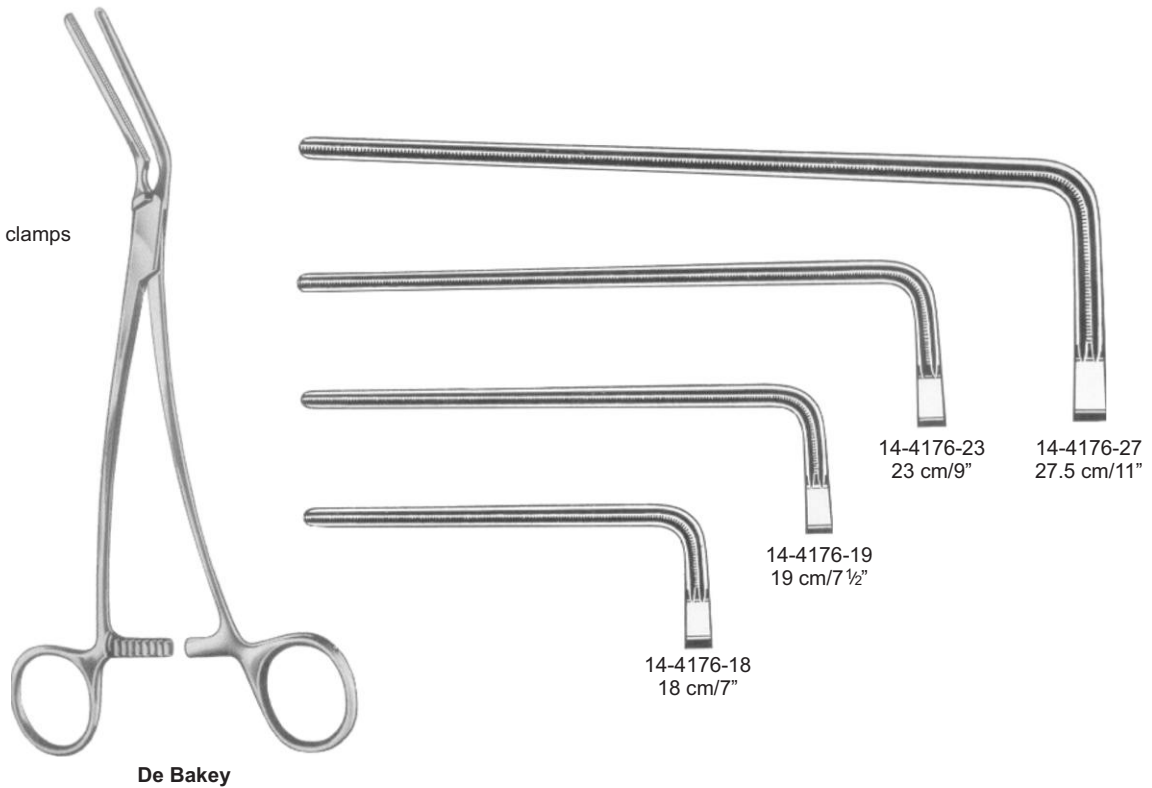

CARDIOVASCULAR

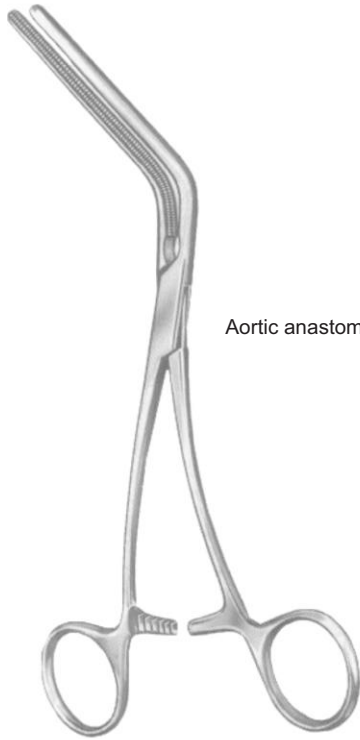

Aortic anastomosis clamps

Morris-De Bakey

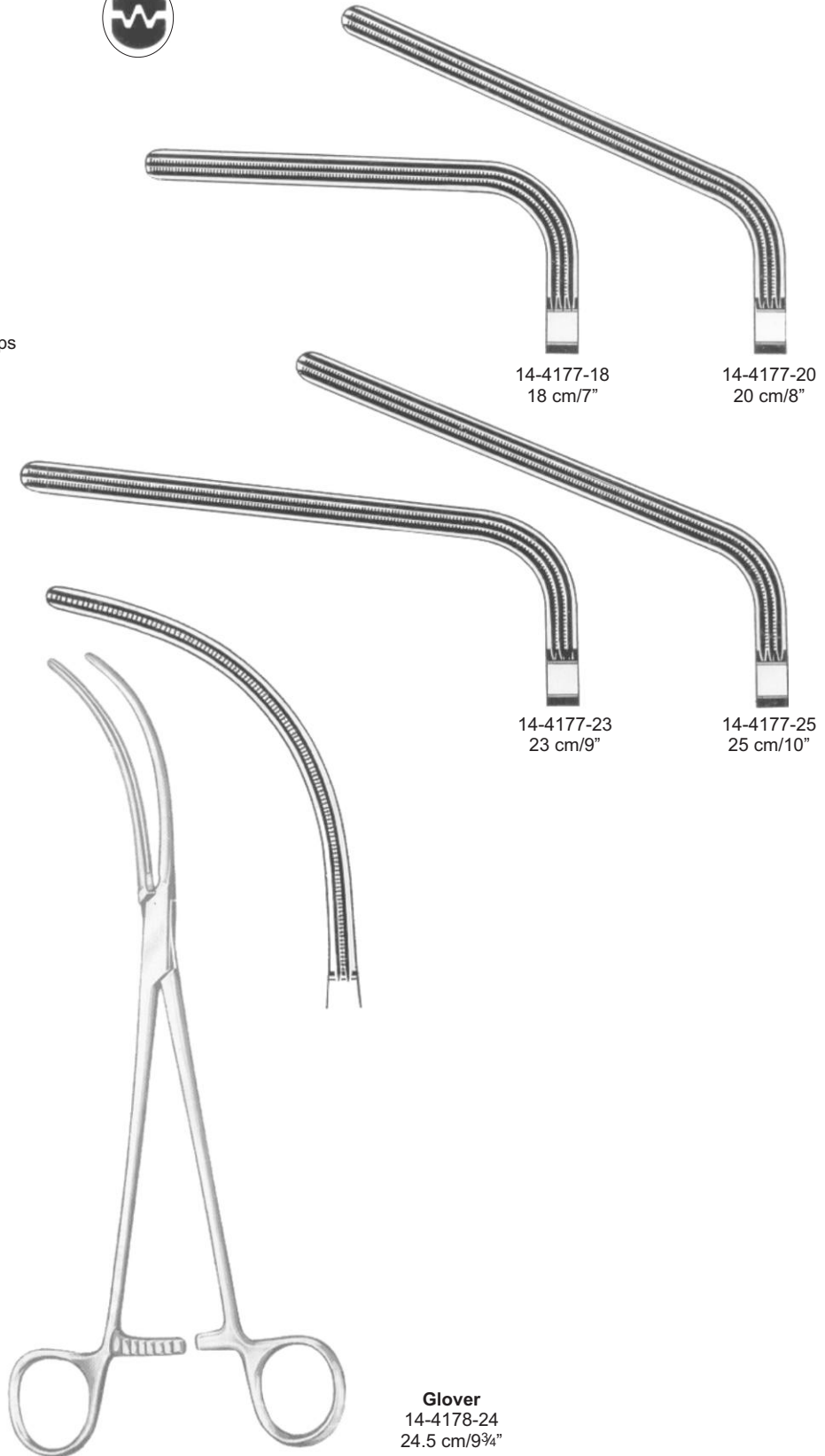

14-4177-18
18 cm/7"

14-4177-20
20 cm/8"

14-4177-23
23 cm/9"

14-4177-25
25 cm/10"

Glover
14-4178-24
24.5 cm/9¾"

CARDIOVASCULAR

Aorta aneurysm clamps



De Bakey-Bahnson



De Bakey



14-4179-24
24.5 cm/9¾"



14-4179-25
25.5 cm/10"



14-4179-26
26.5 cm/10½"

Coarctation clamps



Straight	cm/in	Curved
14-4180-21	21.5 cm/8½"	14-4181-21
14-4180-23	23.0 cm/9"	14-4181-23
14-4180-27	27.0 cm/10½"	14-4181-27
14-4180-31	31.5 cm/12½"	14-4181-31

CARDIOVASCULAR

Multi purpose clamps



De Bakey



De Bakey-Rankin

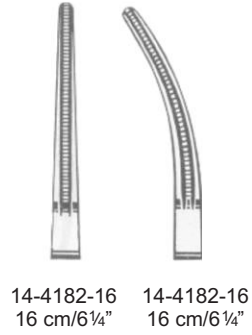

14-4182-16 16 cm/6¼"
14-4182-16 16 cm/6¼"

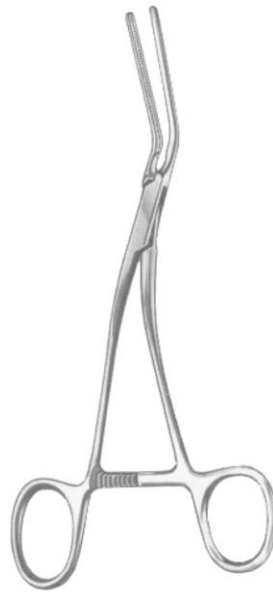

Cooley

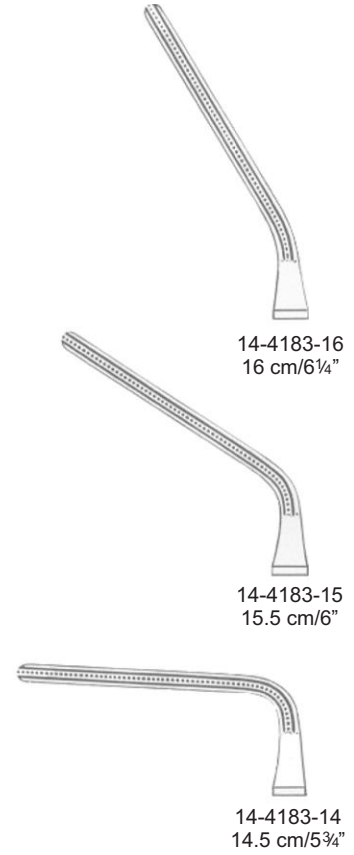

14-4183-16
16 cm/6¼"

14-4183-15
15.5 cm/6"

14-4183-14
14.5 cm/5¾"



De Bakey
14-4184-17
17 cm/6¾"

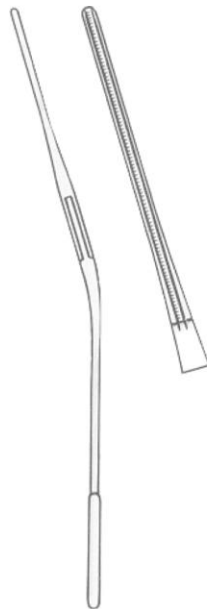

14-4185-17

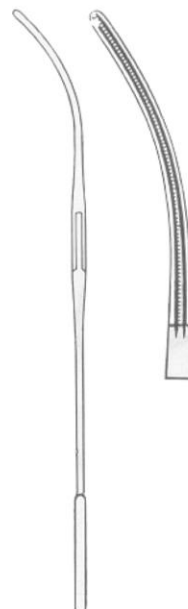

14-4186-17

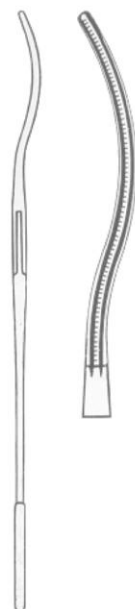

14-4187-17

CARDIOVASCULAR



De Bakey

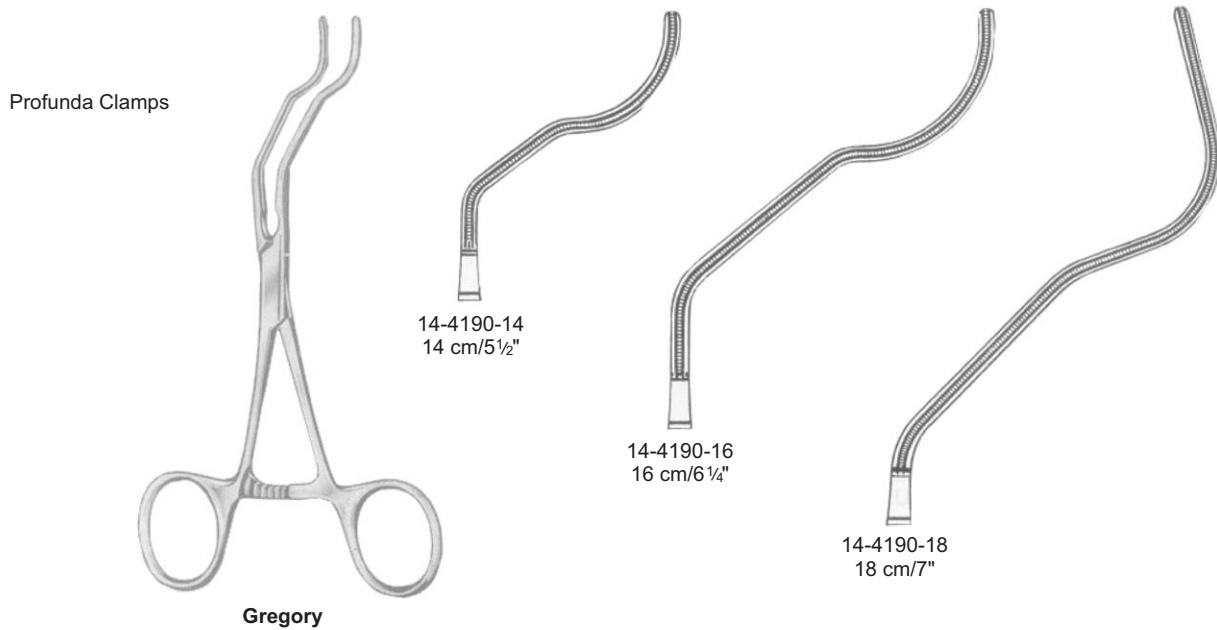
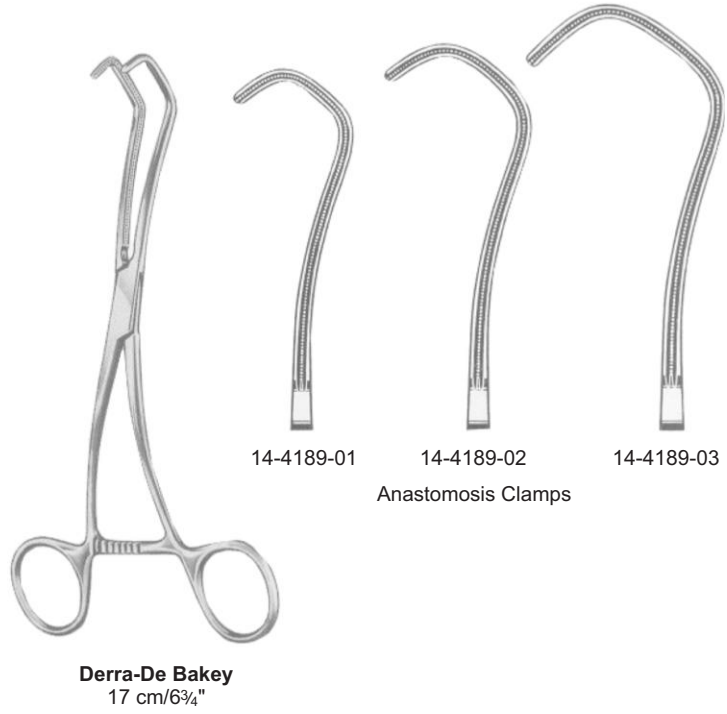
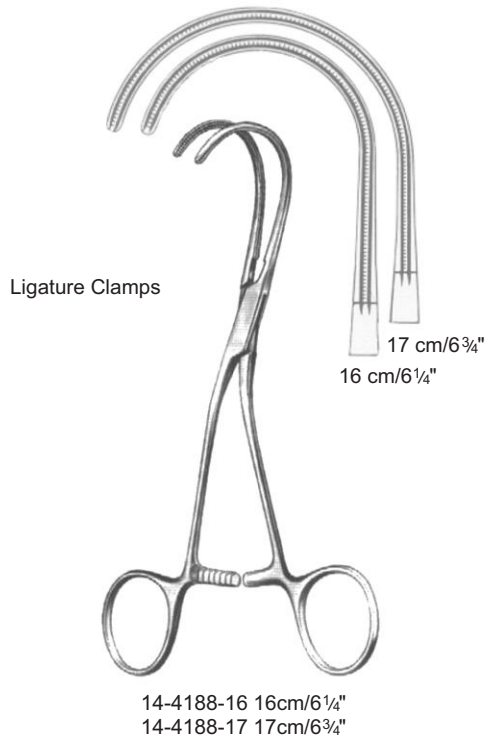

CARDIOVASCULAR



Cooley

Coarctation Clamps

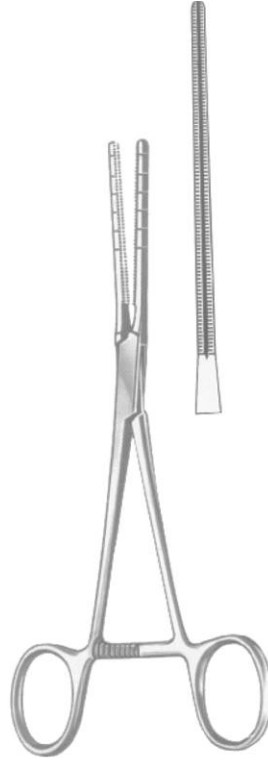

Cooley
 14-4191-17
 17 cm/6¾"

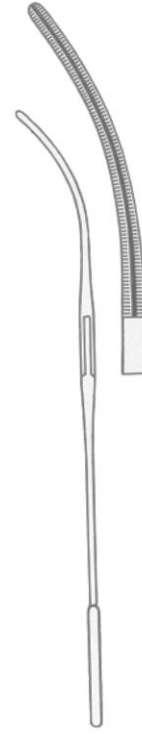

14-4192-17
 17 cm/6¾"

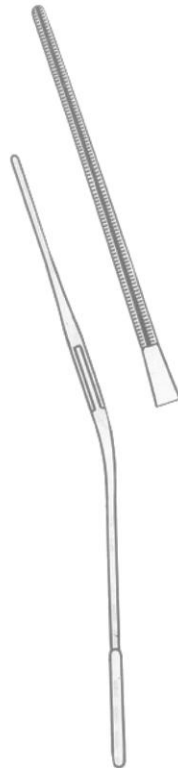

14-4193-17
 17 cm/6¾"

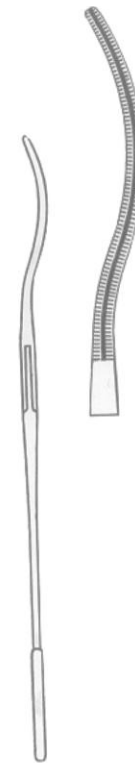

14-4194-17
 17 cm/6¾"

CARDIOVASCULAR



Cooley
14-4195-20
20 cm/8"



Cooley



Cooley

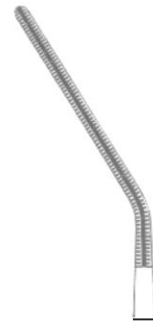

14-4196-03
17 cm/6¾"

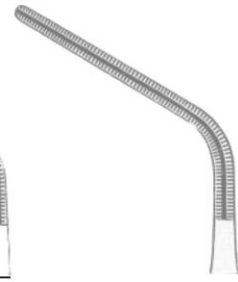

14-4197-02
15.5 cm/6"



14-4198-01
15 cm/6"

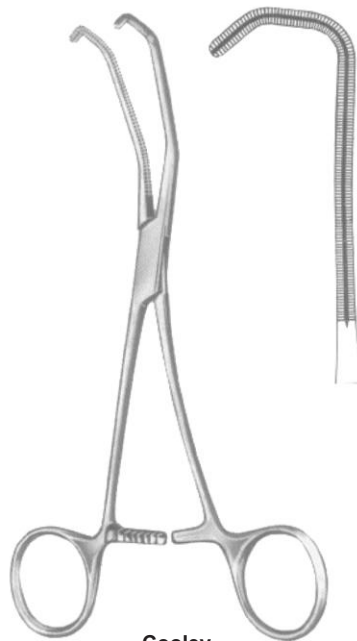

Cooley
14-4199-17
17 cm/6¾"

CARDIOVASCULAR

Anastomosis clamps



Cooley



Cooley

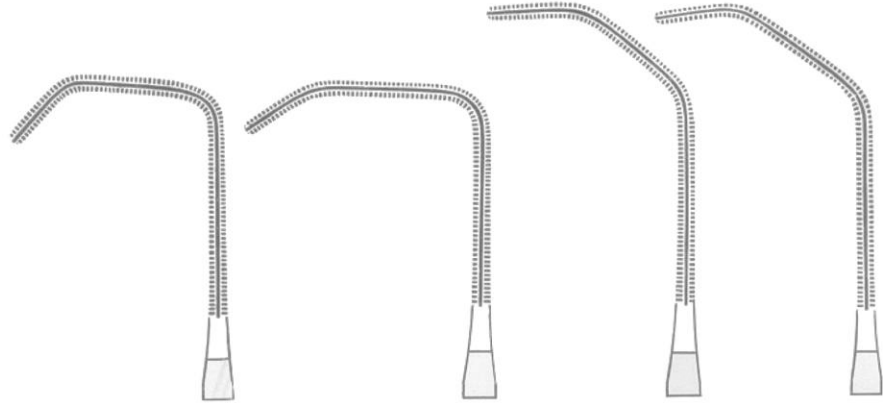

14-4200-01
16.5 cm/6½"

14-4200-02
16.5 cm/6½"

14-4200-03
17.5 cm/7"

29-0980714-4200
17.5 cm/7"

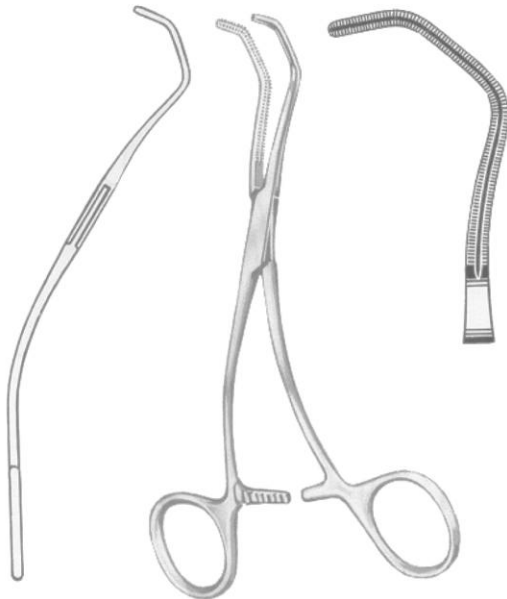

Cooley
14-4201-16
16 cm/6¼"



Beck
14-4202-17
17 cm/6¾"

CARDIOVASCULAR



Cooley



Cooley-Derra



14-4203-16
16 cm/6 1/4"



14-4203-17
17 cm/6 3/4"



14-4203-18
18 cm/7"



Cooley
14-4204-16 16 cm/6 1/4"
14-4204-17 17 cm/6 3/4"



16 cm/6 1/4"

17 cm/6 3/4"

Ligature clamps

CARDIOVASCULAR



Cooley



Cooley
14 cm/5½"

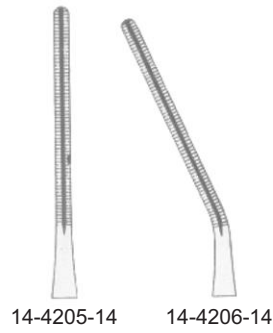

14-4205-14

14-4206-14



Cooley
14-4207-14
14 cm/5½"



Cooley
14-4208-14
14 cm/5½"



Cooley
14-4209-14
14 cm/5½"

CARDIOVASCULAR



Cooley
14-4210-01
25 cm/10"



Cooley
14-4211-02
33 cm/13"



Cooley
14-4212-03
30 cm/12"



Cooley
14-4213-04
30 cm/12"



Cooley
14-4214-05
35 cm/13¾"

Tourniquets



Rumel-Belmont
14-4215-32 3.2 mm Ø
14-4215-64 6.4 mm Ø

CARDIOVASCULAR

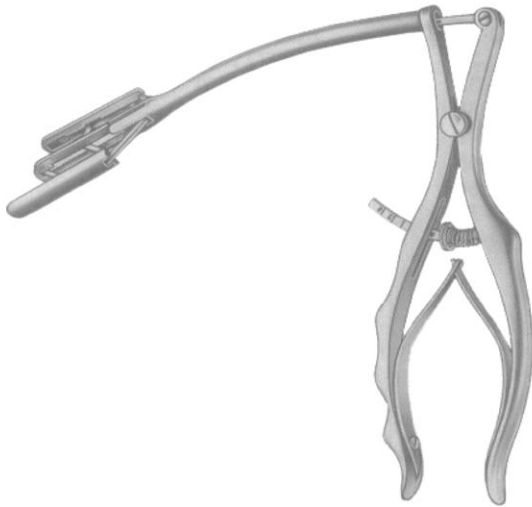

Cooley
14-4216-00



Gerbode
14-4217-00



Tubbs
14-4218-00

CARDIOVASCULAR



De Bakey

mm Ø	19 cm/7 1/2"	35 cm/14"
0.5	14-4219-05	14-4220-05
1.0	14-4219-10	14-4220-10
1.5	14-4219-15	14-4220-15
2.0	14-4219-20	14-4220-20
2.5	14-4219-25	14-4220-25
3.0	14-4219-30	14-4220-30
3.5	14-4219-35	14-4220-35
4.0	14-4219-40	14-4220-40
4.5	14-4219-45	14-4220-45
5.0	14-4219-50	14-4220-50
7.0	14-4219-70	14-4220-70
9.0	14-4219-90	14-4220-90

Malleable

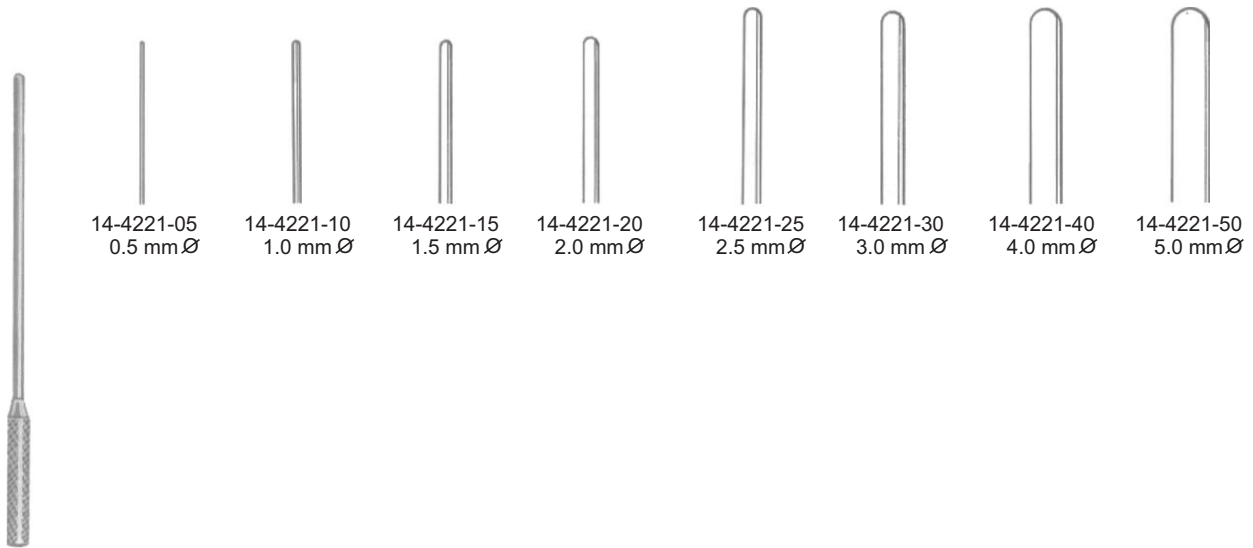

Cooley
13 cm/5"

CARDIOVASCULAR



Sauerbruch
 14-4222-24 24 cm/9½"
 14-4222-26 26 cm/10¼"



Giertz-Stille
 14-4223-27
 27 cm/10½"

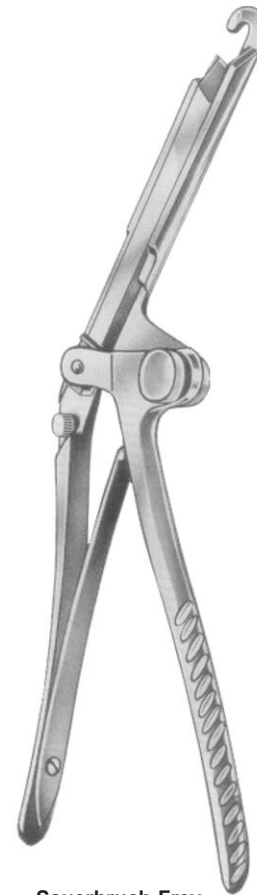

Sauerbruch-Frey
 14-4224-36
 36 cm/14"



Bethune
 14-4225-34
 34 cm/13½"

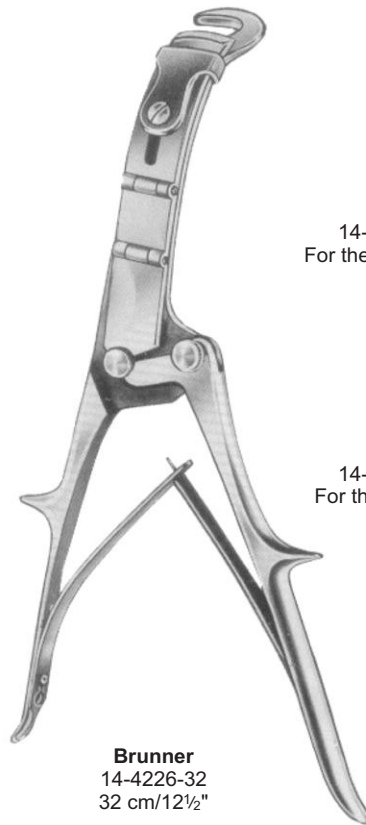

Brunner
 14-4226-32
 32 cm/12½"

14-4226-32
 For the Right Hand

14-4227-32
 For the left Hand



Lebsche
 14-4228-24
 24.5 cm/9¾"

CARDIOVASCULAR

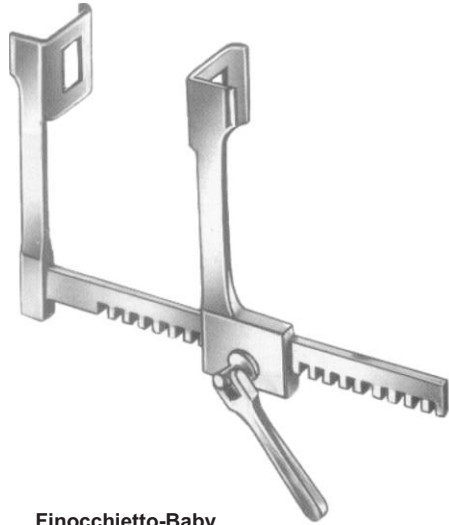

Finocchietto-Baby

	a	b	c
14-4229-00	18 mm	21 mm	105 mm

Scheme of Dimensions

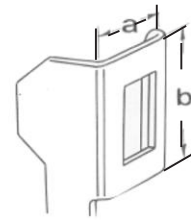

Size of Blades

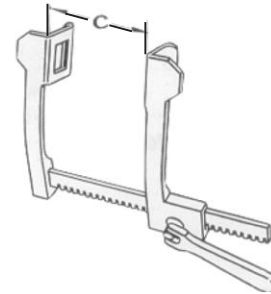

Total Spread



Finocchietto

	a	b	c
14-4230-01	36 mm	45 mm	165 mm
14-4230-02	44 mm	65 mm	200 mm
14-4230-03	44 mm	65 mm	250 mm
14-4230-04	44 mm	65 mm	300 mm
14-4230-05	65 mm	65 mm	200 mm
14-4230-06	65 mm	65 mm	250 mm
14-4230-07	65 mm	65 mm	300 mm

CARDIOVASCULAR

With 2 Pairs of Interchangeable Blades

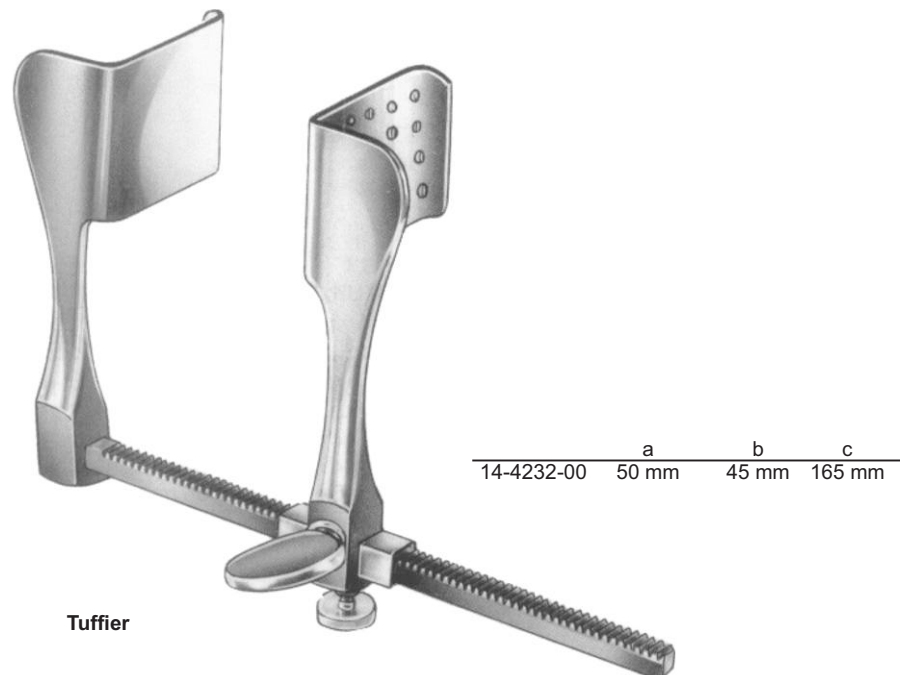
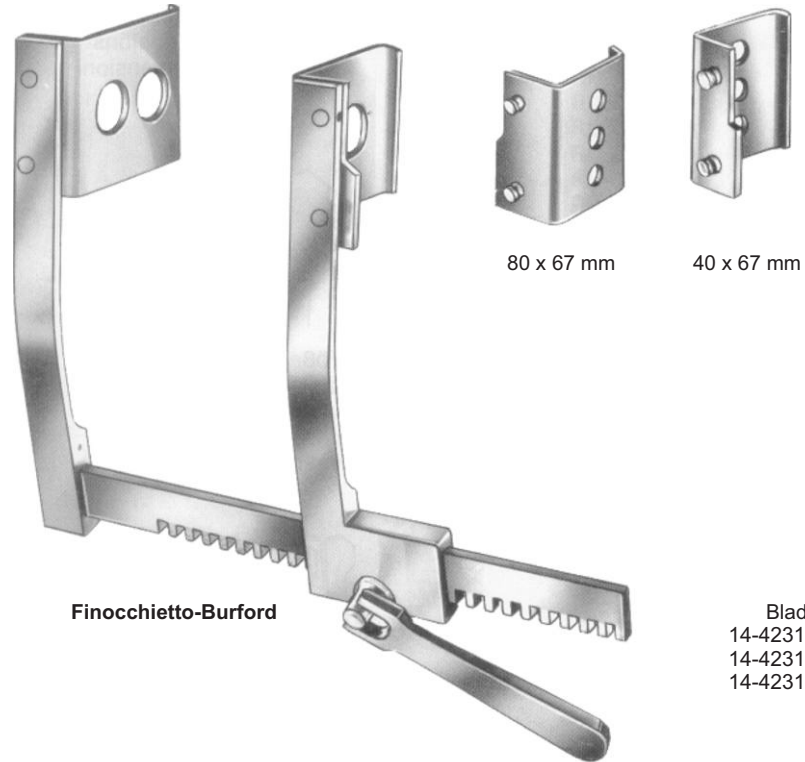

CARDIOVASCULAR

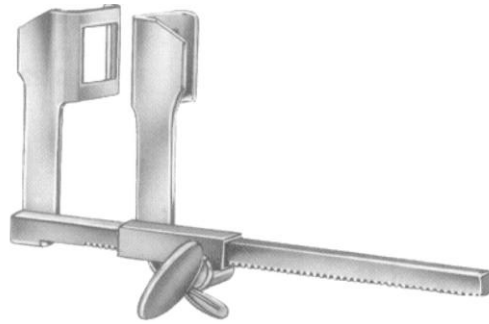

Haight

	a	b	c
14-4233-00	30 mm	30 mm	115 mm

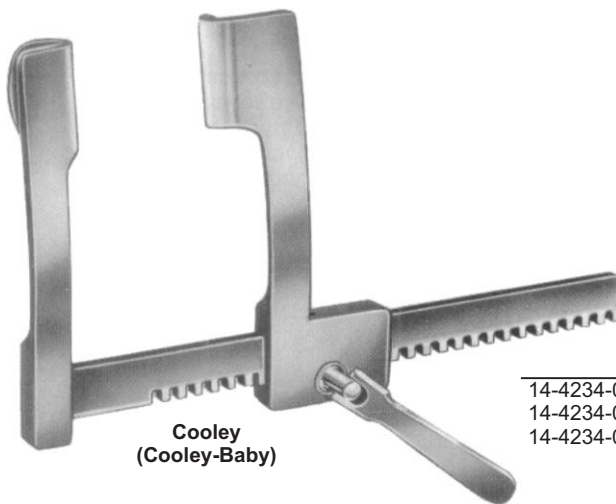

**Cooley
(Cooley-Baby)**

	a	b	c
14-4234-01	15 mm	30 mm	75 mm
14-4234-02	21 mm	45 mm	145 mm
14-4234-03	32 mm	50 mm	190 mm

CARDIOVASCULAR

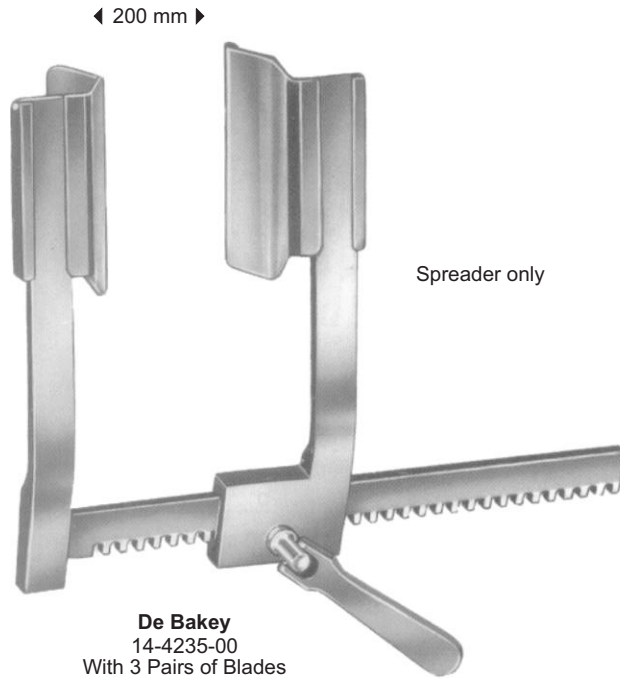

De Bakey
 14-4235-00
 With 3 Pairs of Blades
 14-4235-01
 14-4235-02
 14-4235-03

Spreader only

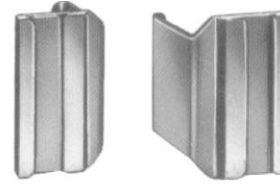

14-4235-01
 60 x 60 mm

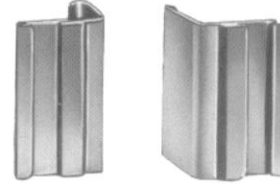

14-4235-02
 50 x 80 mm

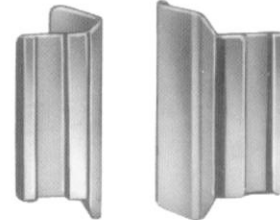

14-4235-03
 40 x 100 mm

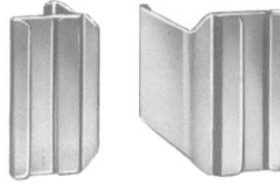

14-4235-04
 80 x 60 mm



14-4235-05
 50 x 66 mm

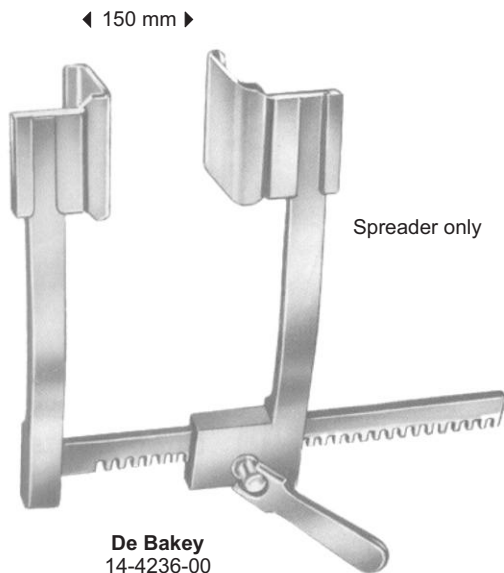

De Bakey
 14-4236-00
 With 3 Pairs of Blades

Spreader only



14-4236-01
 30 x 30 mm

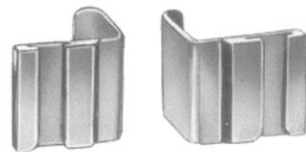

14-4236-02
 40 x 40 mm

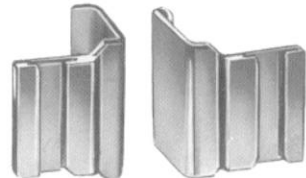

14-4236-03
 50 x 50 mm

CARDIOVASCULAR

◀ Fig. 1 15 cm/6" ▶
◀ Fig. 2 20 cm/8" ▶

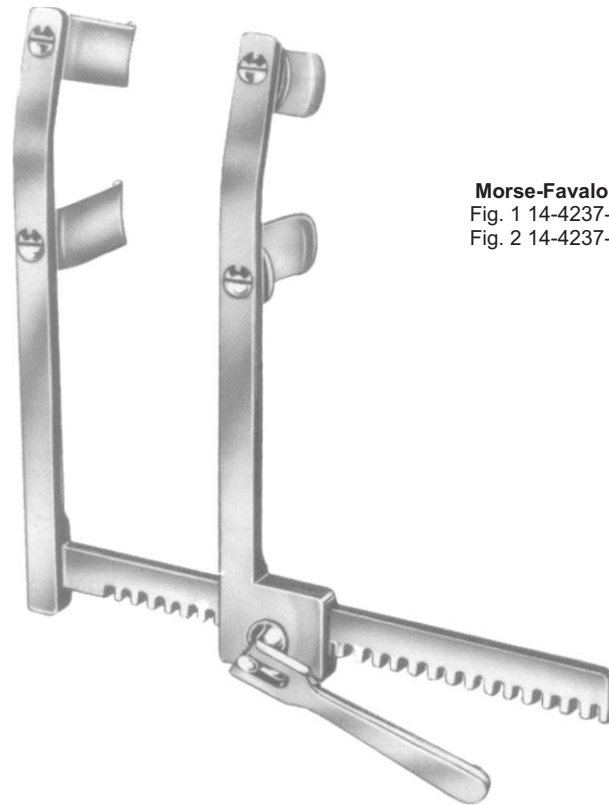

Morse-Favaloro
Fig. 1 14-4237-01
Fig. 2 14-4237-02

75 x 75 mm

42 x 65 mm

Thoracic Retractor

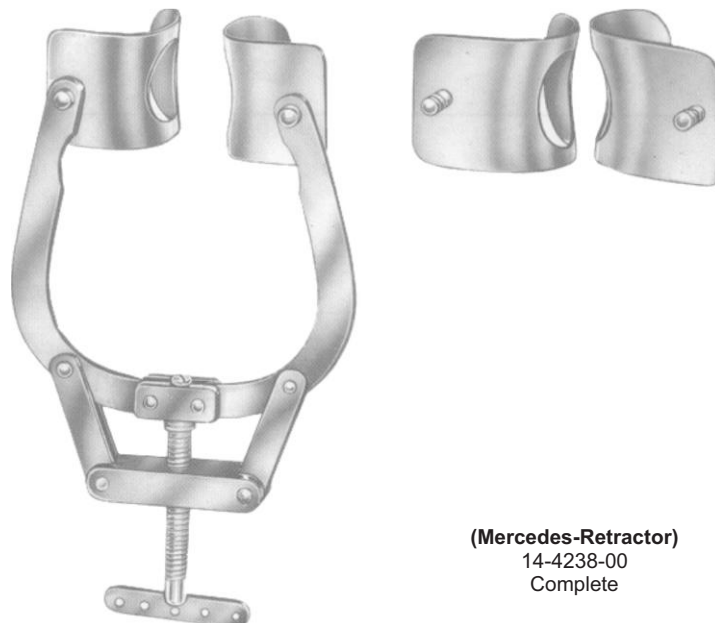

(Mercedes-Retractor)
14-4238-00
Complete

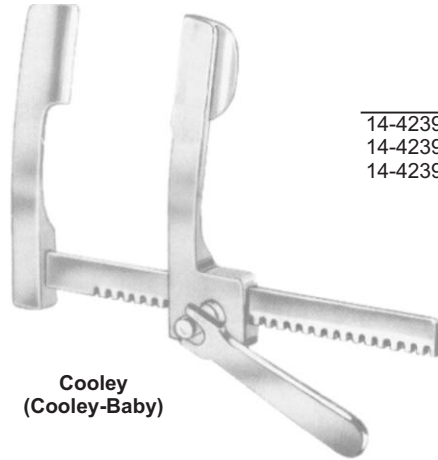
CARDIOVASCULAR

**Cooley
(Cooley-Baby)**

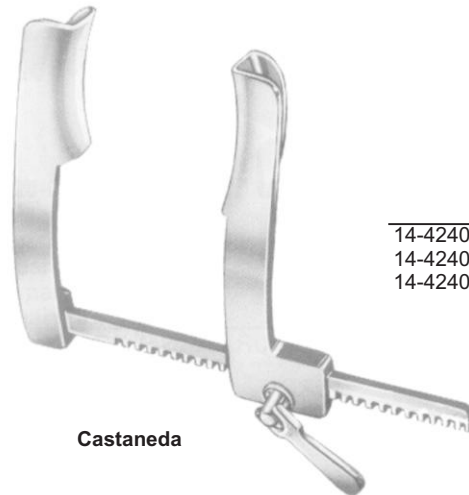
	a	b	c
14-4239-01	12 mm	17 mm	75 mm
14-4239-02	16 mm	30 mm	105 mm
14-4239-03	37 mm	49 mm	200 mm

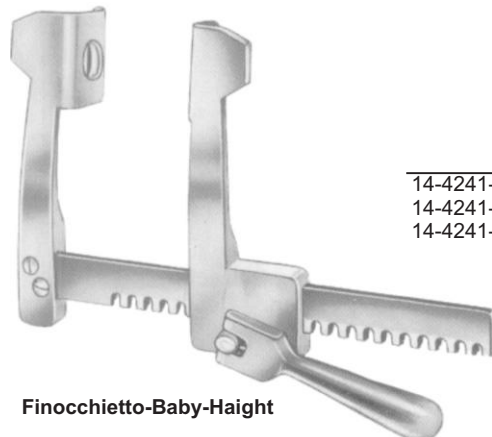

Castaneda

	a	b	c
14-4240-01	10.5 mm	32 mm	65 mm
14-4240-02	12 mm	45 mm	70 mm
14-4240-03	15 mm	60 mm	120 mm

Finocchietto-Baby-Haight

	a	b	c
14-4241-01	15 mm	15 mm	75 mm
14-4241-02	31 mm	31 mm	100 mm
14-4241-03			

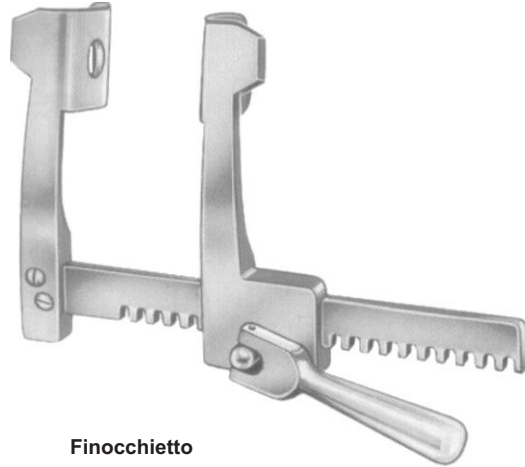
CARDIOVASCULAR



Finocchetto

	a	b	c
14-4242-01	38 mm	44 mm	135 mm
14-4242-02	52 mm	62 mm	135 mm
14-4242-03	85 mm	65 mm	135 mm



Burford
With 2 Pairs of Blades

For Child	a	b	c
14-4243-00	48 mm	42 mm	135 mm
14-4243-01	34 mm	42 mm	135 mm
14-4243-02	65 mm	62 mm	180 mm
14-4243-03	47 mm	62 mm	260 mm
14-4243-03	65 mm	62 mm	300 mm
	47 mm	62 mm	

CARDIOVASCULAR



Lemmon
 14-4244-18
 18 cm/7"

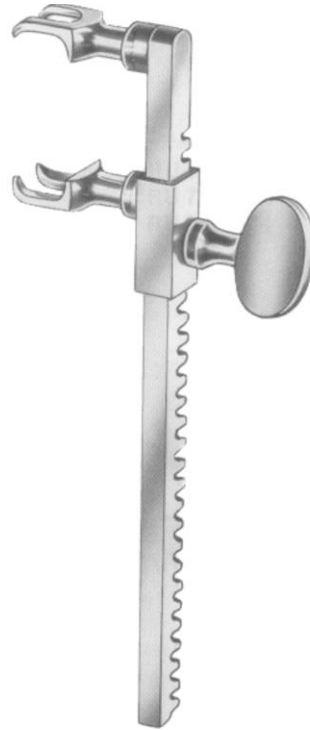

Sellors
 14-4245-19
 19 cm/7½"



Bailey-Baby
 14-4246-14
 14 cm/5½"



Bailey
 14-4247-16
 16 cm/6¼"



Bailey-Gibbon
 14-4248-16
 16 cm/6¼"



Allison
 14-4249-25 25.5 cm/10"
 14-4249-30 30.0 cm/12"

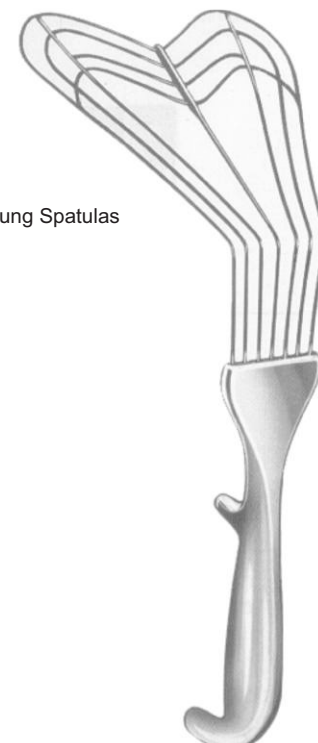

Lung Spatulas

14-4250-30
 30 cm/12"

- EN** Neurosurgery
- DE** Neurochirurgie
- ES** Neuro Cirugía

Page 358 to 388

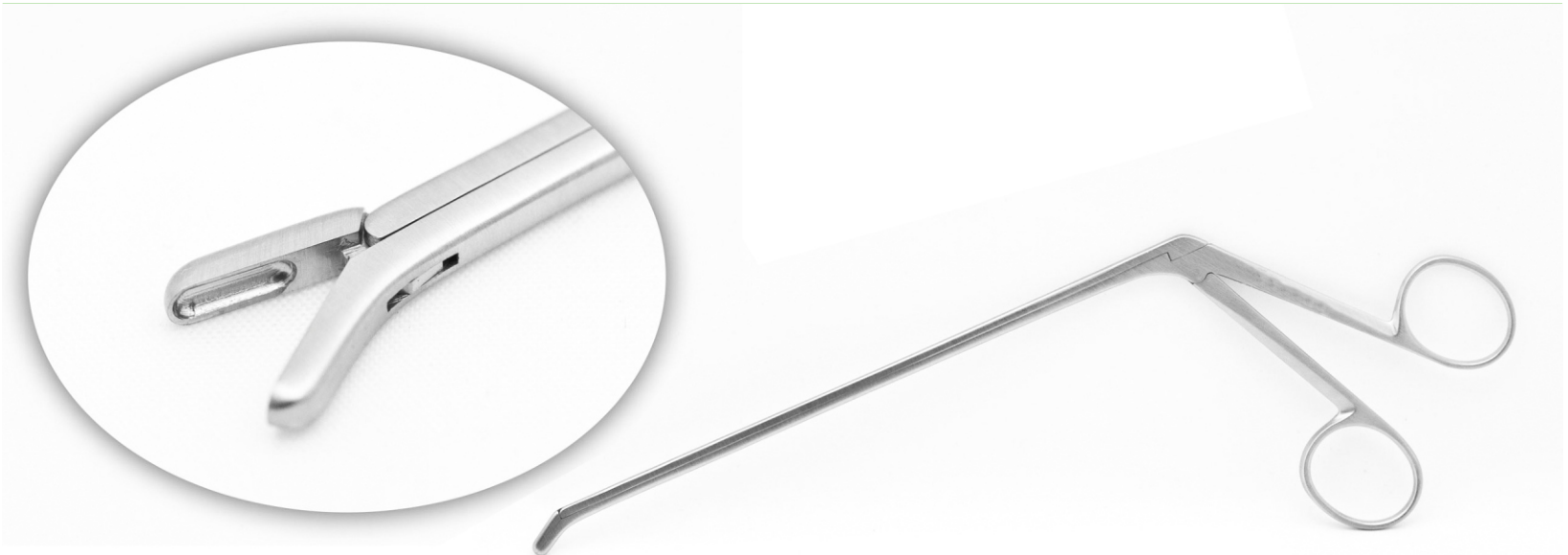

NEURO SURGERY

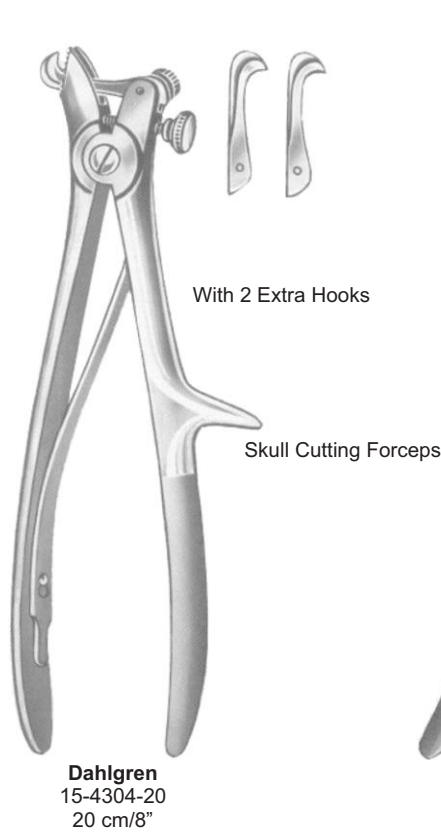
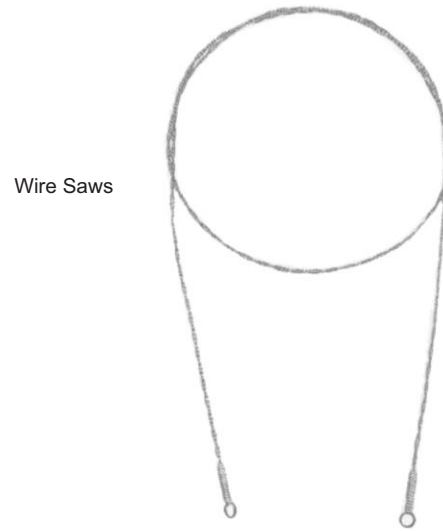

NEURO SURGERY

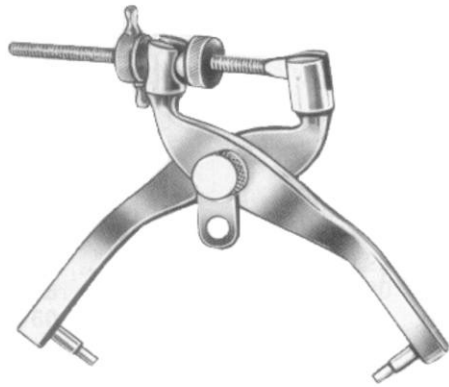

Crutchfield
15-4306-00



Crutchfield
15-4307-00



15-4308-00



Crutchfield
15-4309-00
Complete With 2 Drills

NEURO SURGERY

Applying and Removing Forceps



Raney
15-4310-00
16 cm/6¼"

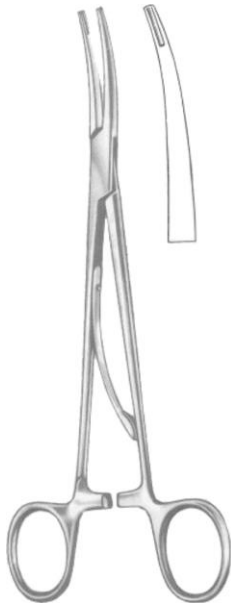

McKenzie
15-4311-15 15 cm/6"
15-4311-19 19 cm/7½"



Olivecrona-Tonnis
15-4312-14

NEURO SURGERY

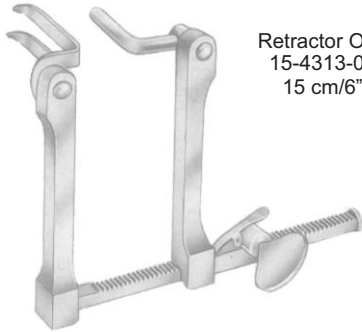

Retractor Only
 15-4313-01
 15 cm/6"

Caspar
 15-4313-00

Retractor Complete With
 1 Blade Each
 15-4313-40
 15-4313-50

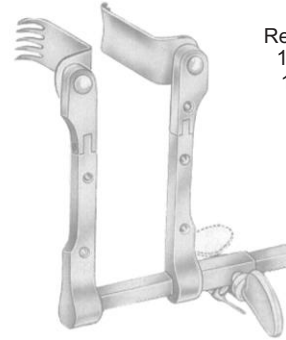

Retractor Only
 15-4314-01
 12 cm/4¾"

Caspar
 15-4314-00

Retractor Complete With
 1 Blade Each
 15-4314-40
 15-4314-50

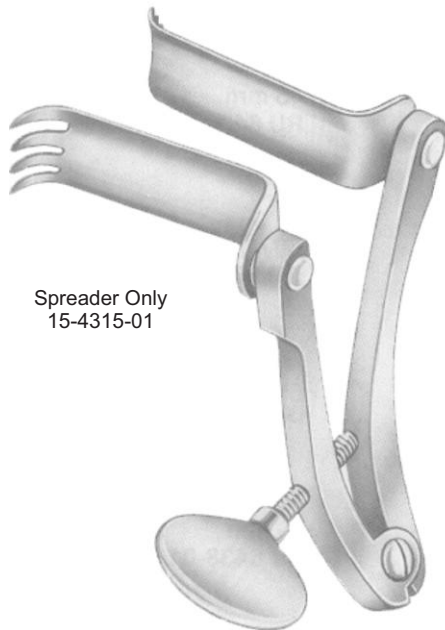

Spreader Only
 15-4315-01

Caspar
 15-4315-00
 Retractors Only
 Spreader Complete With
 1 Blade Each
 15-4315-45
 15-4315-60

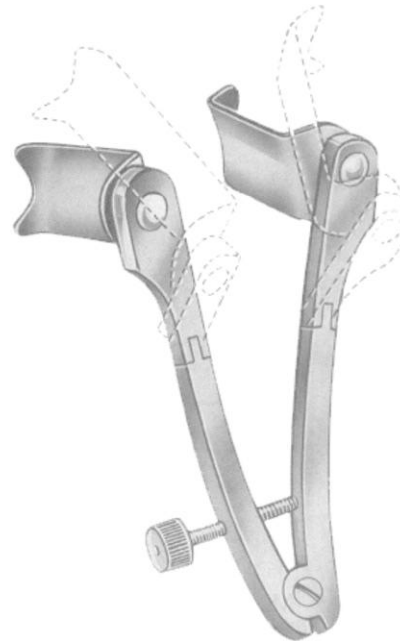

Spreader Only
 15-4316-01

Caspar
 15-4316-00
 Spreader Only
 Retractor Complete With
 1 Blade Each
 15-4316-40
 15-4316-60

NEURO SURGERY

15-4317-01
15 cm/6"
Retractor only

Caspar
15-4317-00
15-4317-45
15-4317-65
Retractor complete with
1 blade each



15-4318-01
15 cm/6"
Retractor only

Caspar
15-4318-00
15-4318-45
15-4318-65
Retractor adjustable, con
1 blade each

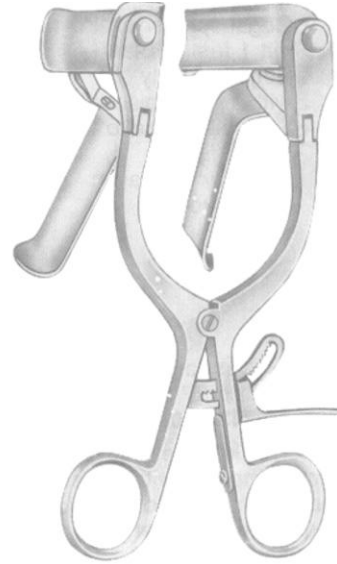

15-4319-01
Retractor only
with 1 fixed blade

Caspar
15-4319-00
Retractor complete,
eith 5 blades

15-4319-40
40 mm

15-4319-45
45 mm

15-4319-50
50 mm

15-4319-55
55 mm

15-4319-60
60 mm

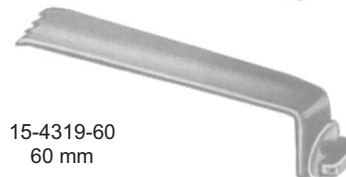

NEURO SURGERY



15-4320-01
Retractor only

Cloward
 15-4320-00
 25 cm/10"
 complete with 5 blades

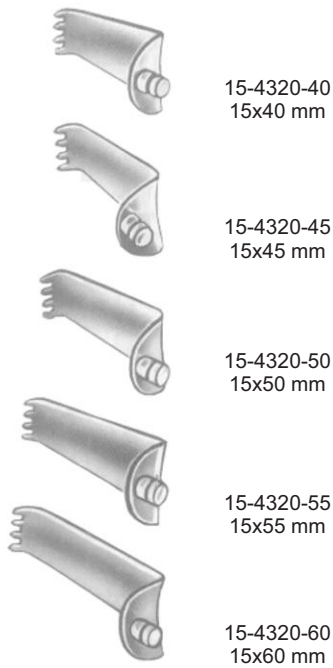

15-4320-40
15x40 mm
 15-4320-45
15x45 mm
 15-4320-50
15x50 mm
 15-4320-55
15x55 mm
 15-4320-60
15x60 mm



15-4321-01
Retractor only

Cloward
 15-4321-00
 15 cm/6"
 complete with 5 blades

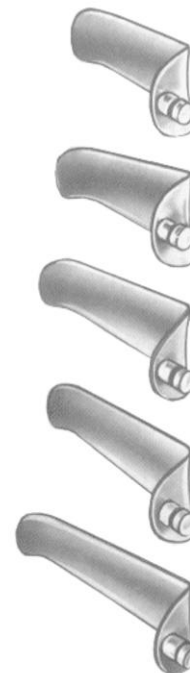

15-4321-40
15x40 mm
 15-4321-45
15x45 mm
 15-4321-50
15x50 mm
 15-4321-55
15x55 mm
 15-4321-60
15x60 mm

NEURO SURGERY



Inge
15-4322-16
16 cm/6¼"



Inge
15-4323-25
27 cm/10¾"



Cloward
15-4324-15
15 cm/6"



Cloward
15-4325-16
16 cm/6¼"

NEURO SURGERY

Muscle blades



Frame
15-4326-01

Hey
15-4327-00
15-4328-00
23 cm/9"



15-4329-50
20x50 mm



15-4329-60
20x60 mm

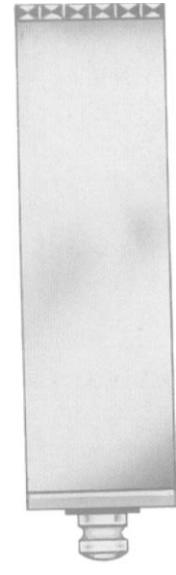

15-4329-70
20x70 mm

Vertebra-pins



15-4330-50
50 mm

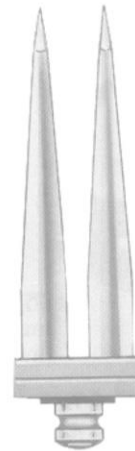

15-4330-60
60 mm



15-4330-70
70 mm

NEURO SURGERY

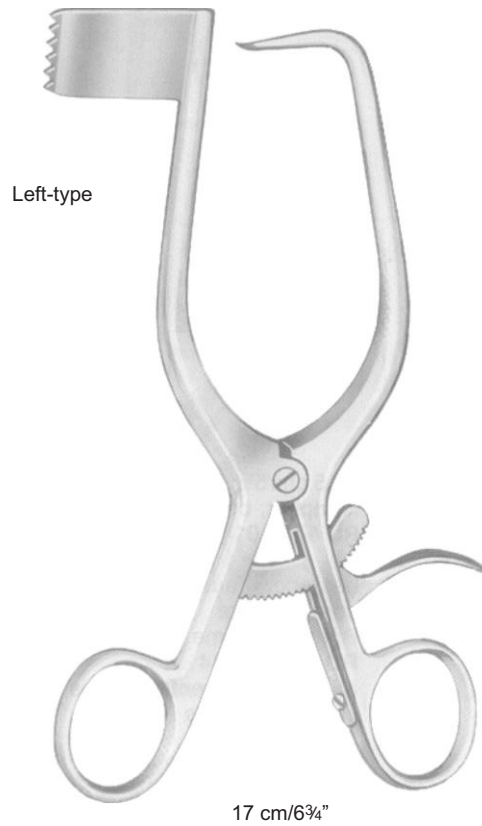

Left-type

Right-type

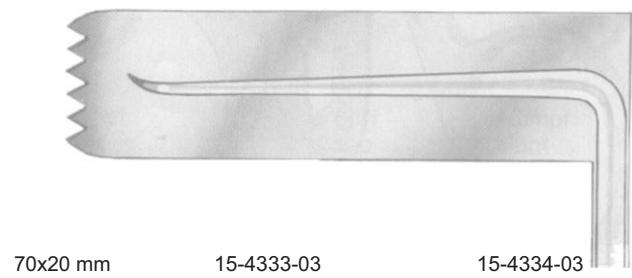
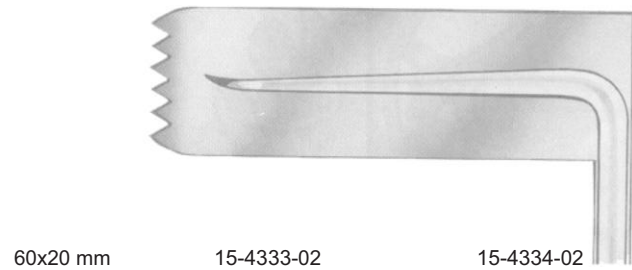
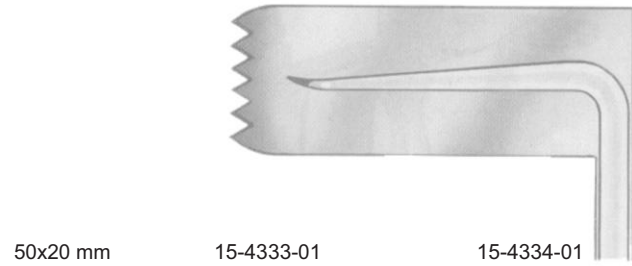
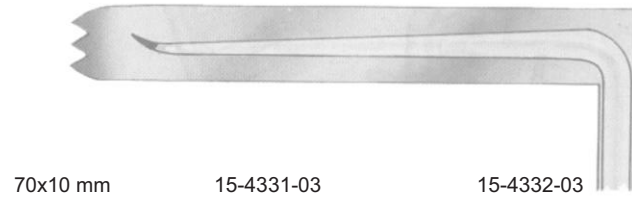
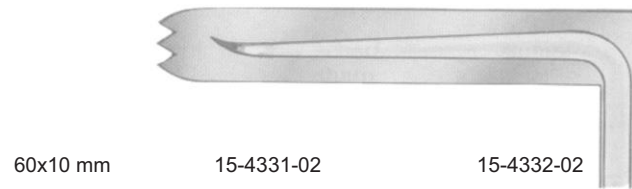
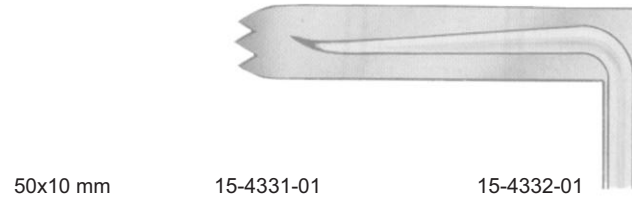

NEURO SURGERY

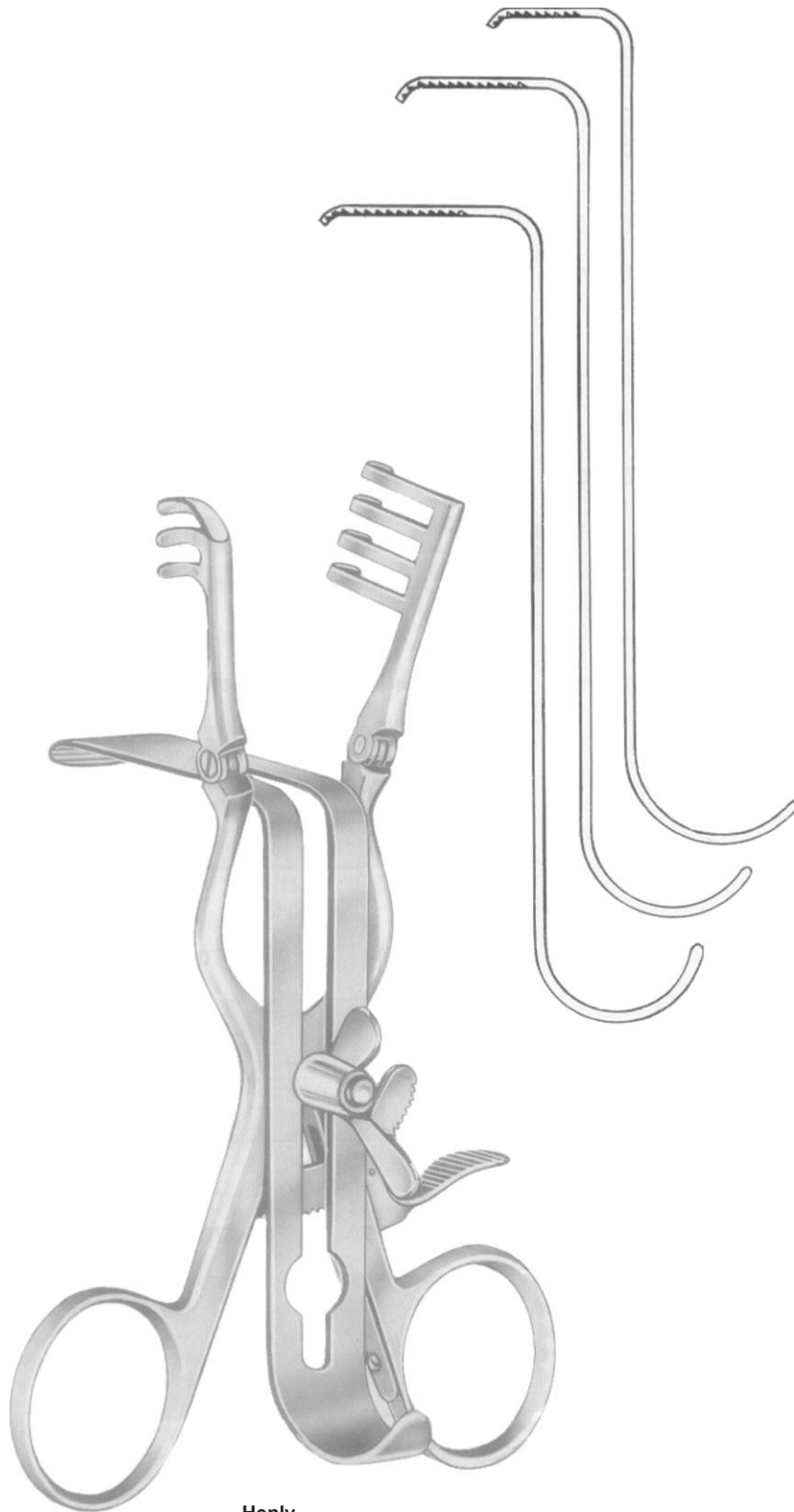

Henly

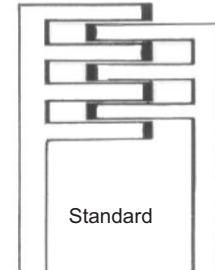

Standard

15-4335-00 Complete 15-4336-00
14.5 cm/5¾" Consisting of 17 cm/6¾"

15-4335-01 Frame 15-4336-01
15-4335-21 Centre Blades 15-4336-21
15-4335-22 15-4336-22
15-4335-23 15-4336-23

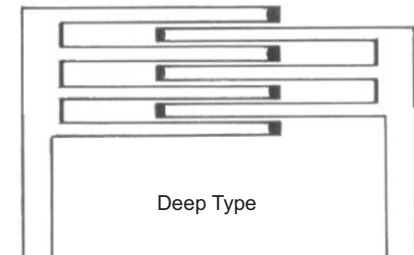

Deep Type

15-4337-00 Complete 15-4338-00
14.5 cm/5¾" Consisting of 17 cm/6¾"

15-4337-01 Centre Blades 15-4338-01
15-4337-21 15-4338-21
15-4337-22 15-4338-22
15-4337-23 15-4338-23

NEURO SURGERY



Davis
15-4339-24
24.5 cm/9 3/4"



Toennis
15-4340-25
25 cm/10"



Frazier
15-4341-15

Hoen
15-4342-15

Hoen
15-4343-15

15 cm/6"



Love-Adson
15-4344-16
16 cm/6 1/2"

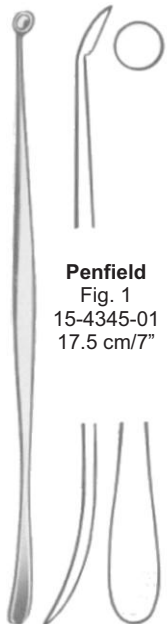

Penfield
Fig. 1
15-4345-01
17.5 cm/7"

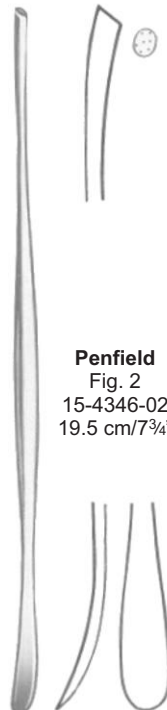

Penfield
Fig. 2
15-4346-02
19.5 cm/7 3/4"

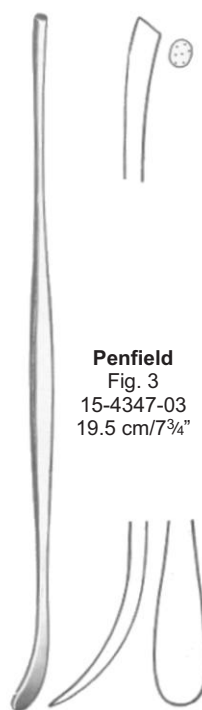

Penfield
Fig. 3
15-4347-03
19.5 cm/7 3/4"

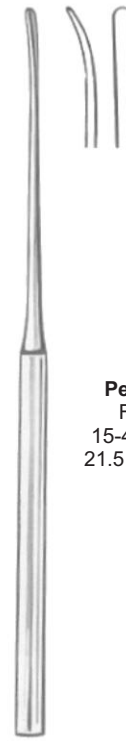

Penfield
Fig. 4
15-4348-04
21.5 cm/8 1/2"



Penfield
Fig. 5
15-4349-05
29 cm/11 1/2"

NEURO SURGERY



Sachs
 15-4350-21
 21 cm/8¼"

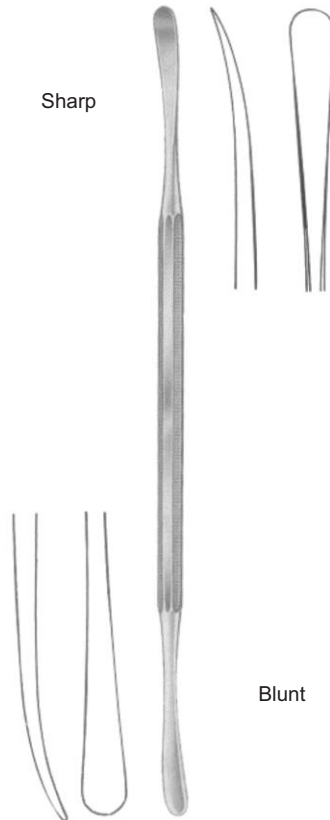

Sharp

Blunt

15-4351-22
 22 cm/8¼"

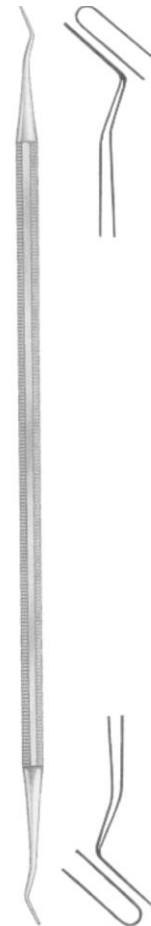

Woodsen
 15-4352-25
 25 cm/10"



Fragar
 15-4353-20
 20 cm/8"



Fragar
 15-4354-20
 20 cm/8"



Sachs
 15-4355-21
 21 cm/8¼"

NEURO SURGERY



Milligan
15-4356-21
21 cm/8¼"

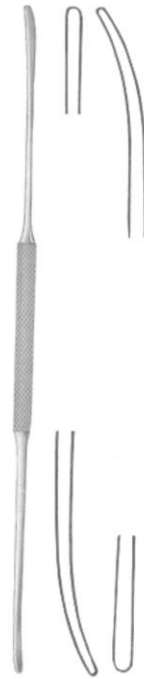

Olivecrona
15-4357-18 18 cm/7"
15-4357-24 24 cm/9½"

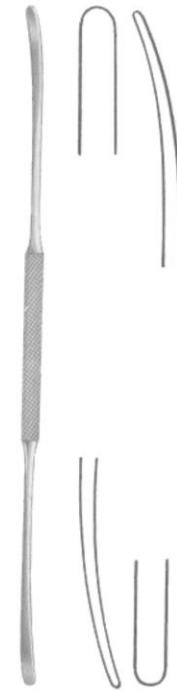

Olivecrona
15-4358-19 19.5 cm/7¾"
15-4358-24 24 cm/9½"



Horsley
15-4359-20
20 cm/8"



Sachs
15-4360-21
21 cm/8¼"

NEURO SURGERY



Cushing
 17 cm/6¾"
 20 cm/8"
 28 cm/11"

15-4361-17
 15-4361-20
 15-4361-28

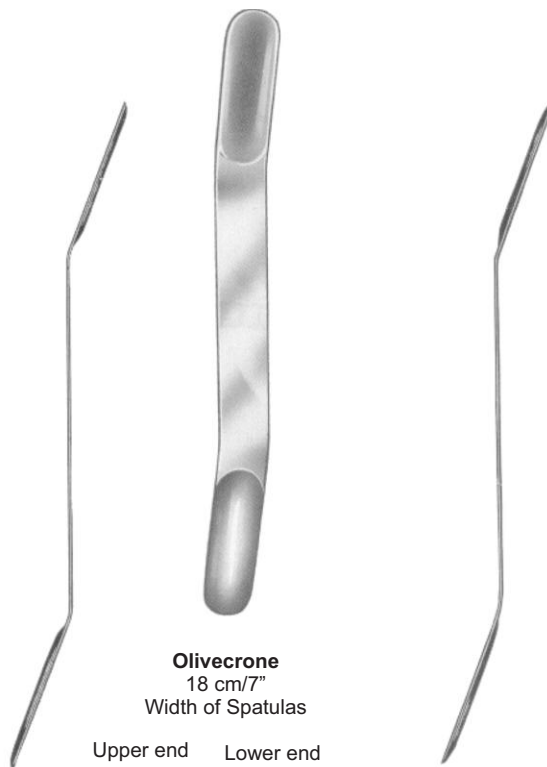

Olivecrona
 18 cm/7"
 Width of Spatulas

	Upper end		Lower end		
	Concave	mm	mm	Convex	
	15-4362-01	7	9	15-4363-01	
	15-4362-02	11	13	15-4363-02	
	15-4362-03	15	18	15-4363-03	
	15-4362-04	18	22	15-4363-04	



Heifetz
 20 cm/8"

Width of Spatulas		
Upper end		Lower end
mm		mm
7	15-4364-08	8
10	15-4364-11	11
13	15-4364-13	14
16	15-4364-17	17
19	15-4364-20	20
22	15-4364-25	22



Heifetz
 15.5 cm/6"

Width of Spatulas	
	mm
15-4365-08	8
15-4365-11	11
15-4365-13	14
15-4365-17	17

Length of Spatulas

NEURO SURGERY

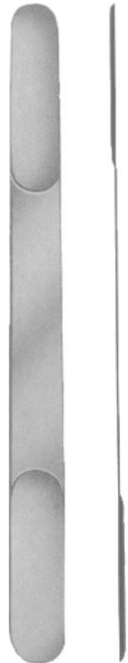

18 cm/7"

Width of spatulas

Upper end	Lower end	
mm	mm	
7	9	15-4366-09
11	13	15-4366-13
15	18	15-4366-18
18	22	15-4366-22



20 cm/8"
 12 mm 15-4367-12
 17 mm 15-4367-17



20 cm/8"
 14 mm 15-4368-14
 17 mm 15-4368-17
 20 mm 15-4368-20



15-4369-01
 19cm/7½"



Love
 15-4370-02
 19 cm/7½"



15-4371-03



Love
 15-4372-21
 21 cm/8¼"

NEURO SURGERY

Length of spatulas



70 mm
3 mm 15-4373-03

100 mm
15-4374-03



5 mm 15-4373-05

15-4374-05



7 mm 15-4373-07

15-4374-07

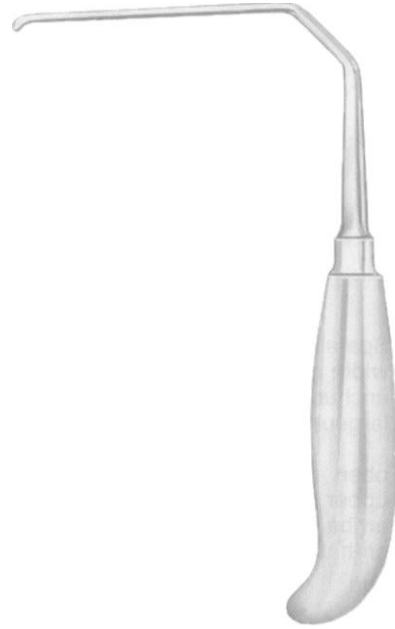

Love



7 mm 15-4375-07
9 mm 15-4375-09

Scoville
23 cm/9"



Holsher
7mm 15-4376-07
9mm 15-4376-09
24 cm/9½"

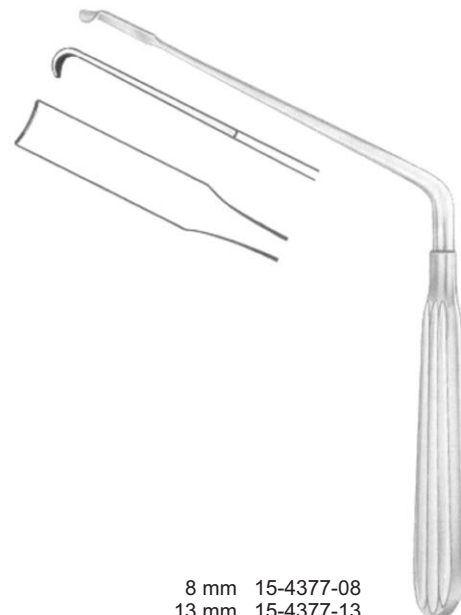

8 mm 15-4377-08
13 mm 15-4377-13

NEURO SURGERY



Taylor
30x 70 mm 15-4378-07 17 cm/6¾"
30x100 mm 15-4378-10 17 cm/6¾"



Oldberg
21 cm/8¼"



15-4379-01



15-4379-02



15-4379-03



15-4379-04

NEURO SURGERY



Cushing
 15-4380-19 19 cm/7 $\frac{3}{4}$ "
 15-4380-28 28 cm/11"



Smithwick
 15-4381-17 17 cm/6 $\frac{1}{2}$ "
 15-4381-21 21 cm/8 $\frac{1}{4}$ "



Cushnig
 15-4382-14
 14 cm/5 $\frac{1}{2}$ "



Adson
 20 cm/8"



15-4383-01



15-4383-02

NEURO SURGERY



Cloward
15-4384-16
16 cm/6 1/2"



Hoen
15-4385-22
22 cm/8 3/4"



Dandy
15-4386-01
20 cm/8"



Dandy
15-4387-02
20 cm/8"



Dandy
15-4388-03
20 cm/8"



Smithwick
15-4389-29
29 cm/11 3/4"



Scoville
15-4390-30
30 cm/12"



Scoville
15-4391-30
30 cm/12"

NEURO SURGERY



Graham
 15-4392-16
 16.5 cm/6½"



Toennis
 15-4393-15
 15 cm/6"



Frazier
 15-4394-13 13 cm/5"
 15-4394-18 18 cm/7"



Toennis
 15-4395-13 13 cm/5"
 15-4395-18 18 cm/7"



Olivecrona
 15-4396-23
 23 cm/9"



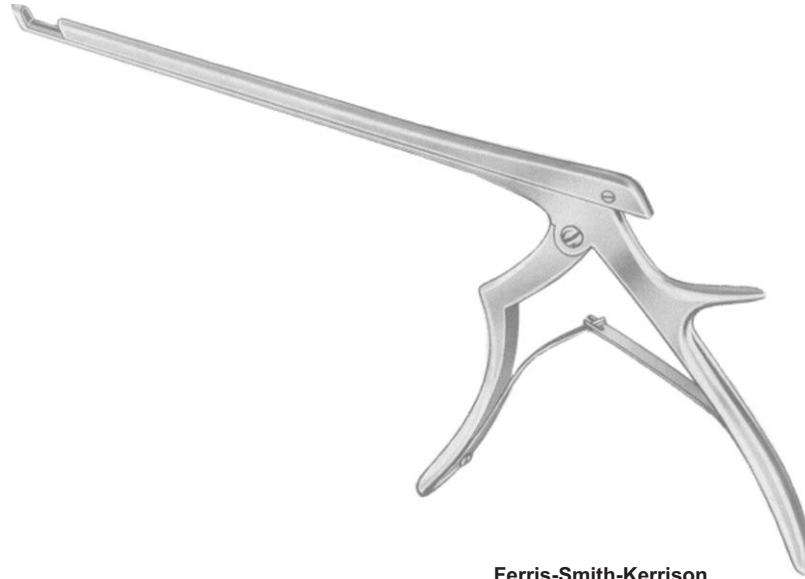

Olivecrona
 15-4397-20
 20.5 cm/8"

NEURO SURGERY





Ferris-Smith-Kerrison

		Width of Bite	Length of Shaft		
			15 cm/6"	20 cm/8"	18 cm/7"
Cutting Upward		0.6 mm			15-4404-00
		1 mm			15-4404-01
		2 mm			15-4404-02
		3 mm	15-4398-03	15-4401-03	15-4404-03
		4 mm			15-4404-04
		5 mm	15-4398-05	15-4401-05	15-4404-05
Cutting Upward 40°		0.6 mm			15-4405-00
		1 mm			15-4405-01
		2 mm			15-4405-02
		3 mm	15-4399-03	15-4402-03	15-4405-03
		4 mm			15-4405-04
		5 mm	15-4399-05	15-4402-05	15-4405-05
Cutting Downwards		0.6 mm			15-4406-00
		1 mm			15-4406-01
		2 mm			15-4406-02
		3 mm	15-4400-03	15-4403-03	15-4406-03
		4 mm			15-4406-04
		5 mm	15-4400-05	15-4403-05	15-4406-05

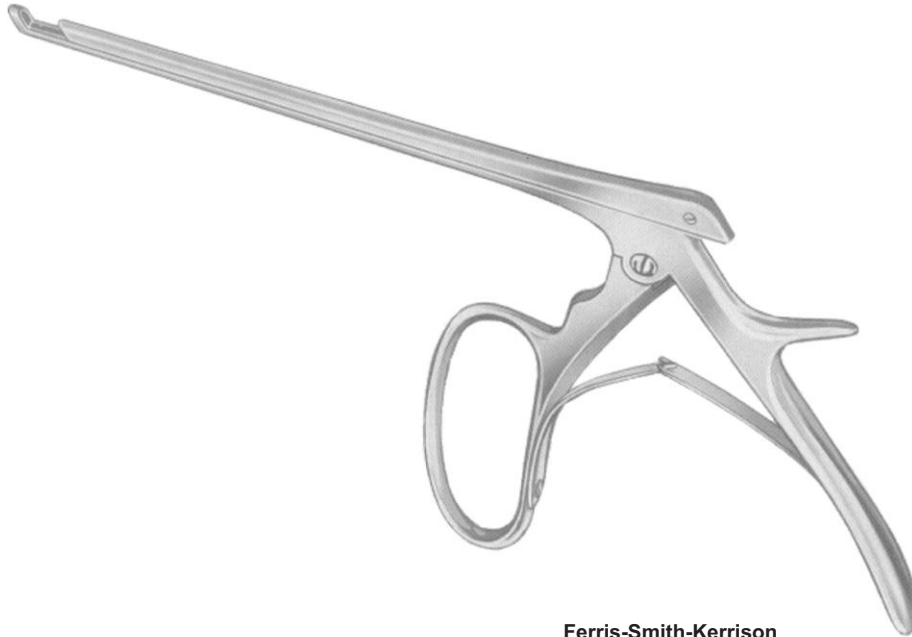
NEURO SURGERY







Ferris-Smith-Kerrison

		Width of Bite		Length of Shaft	
		3 mm	5 mm	20 cm/8"	18 cm/7"
Cutting Upward		15 cm/6"	15 cm/6"	15-4407-03 15-4407-05	15-4410-03 15-4410-05 15-4413-03 15-4413-05
Cutting Upward 40°		15 cm/6"	15 cm/6"	15-4408-03 15-4408-05	15-4411-03 15-4411-05
Cutting Downward		15 cm/6"	15 cm/6"	15-4409-03 15-4409-05	15-4412-03 15-4412-05 15-4414-03 15-4414-05



NEURO SURGERY

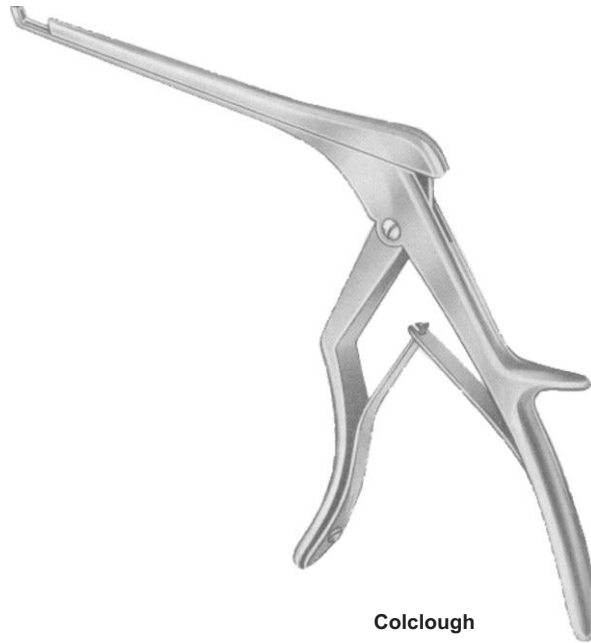

Love-Kerrison

		Width of Bite		Length of Shaft		
		2 mm	3 mm	15 cm/6"	20 cm/8"	18 cm/7"
Cutting Upward		2 mm				15-4419-02
		3 mm	15-4415-03	15-4417-03		15-4419-03
		4 mm	15-4415-04	15-4417-04		15-4419-04
		5 mm	15-4415-05	15-4417-05		15-4419-05
		6 mm				15-4419-06
Cutting Upward 40°		2 mm				15-4420-02
		3 mm				15-4420-03
		4 mm				15-4420-04
		5 mm				15-4420-05
		6 mm				15-4420-06
Cutting Downward		2 mm				15-4421-02
		3 mm	15-4416-03	15-4418-03		15-4421-03
		4 mm	15-4416-04	15-4418-04		15-4421-04
		5 mm	15-4416-05	15-4418-05		15-4421-05
		6 mm				15-4421-06
Cutting Upward 40°		2 mm				15-4422-02
		3 mm				15-4422-03
		4 mm				15-4422-04
		5 mm				15-4422-05
		6 mm				15-4422-06

NEURO SURGERY

Colclough

		Width of Bite	Length of Shaft	
			15 cm/6"	20 cm/8"
Cutting Upward		3 mm	15-4423-03	15-4426-03
		5 mm	15-4423-05	15-4426-05
Cutting Upward 40°		3 mm	15-4424-03	15-4427-03
		5 mm	15-4424-05	15-4427-05
Cutting Downward		3 mm	15-4425-03	15-4428-03
		5 mm	15-4425-05	15-4428-05

NEURO SURGERY



	Length Of Shaft			
Cushing 2 x 10 cm	5"/13 cm	15-4429-01	15-4430-02	15-4431-03
	6"/15 cm	15-4429-01	15-4430-02	15-4431-03
	7"/18 cm	15-4429-01	15-4430-02	15-4431-03
Love-Grunwald 3 x 10 cm	5"/13 cm	15-4429-01	15-4430-02	15-4431-03
	6"/15 cm	15-4429-01	15-4430-02	15-4431-03
	7"/18 cm	15-4429-01	15-4430-02	15-4431-03
Spurling 4 x 10 cm	5"/13 cm	15-4429-01	15-4430-02	15-4431-03
	6"/15 cm	15-4429-01	15-4430-02	15-4431-03
	7"/18 cm	15-4429-01	15-4430-02	15-4431-03

NEURO SURGERY



With Suction/Irrigation Device

	Length Of Shaft			
Cushing 2 x 10 cm	5"/13 cm	15-4432-01	15-4433-02	15-4434-03
	6"/15 cm	15-4432-01	15-4433-02	15-4434-03
	7"/18 cm	15-4432-01	15-4433-02	15-4434-03
Love-Grunwald 3 x 10 cm	5"/13 cm	15-4432-01	15-4433-02	15-4434-03
	6"/15 cm	15-4432-01	15-4433-02	15-4434-03
	7"/18 cm	15-4432-01	15-4433-02	15-4434-03
Spurling 4 x 10 cm	5"/13 cm	15-4432-01	15-4433-02	15-4434-03
	6"/15 cm	15-4432-01	15-4433-02	15-4434-03
	7"/18 cm	15-4432-01	15-4433-02	15-4434-03

NEURO SURGERY

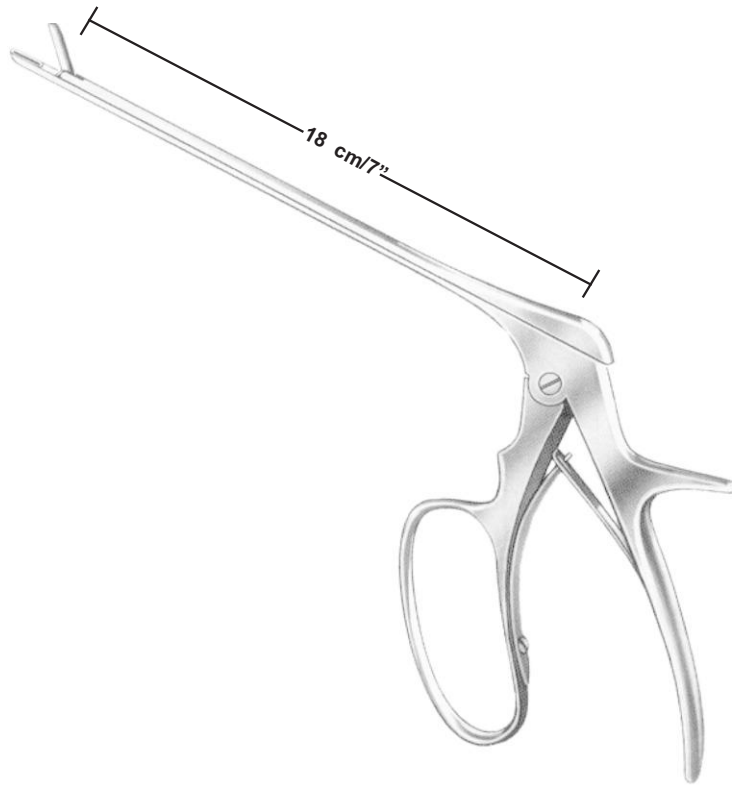

Ferris-Smith

Width Of Jaw

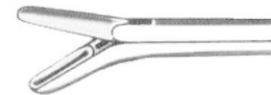

2 x 10 mm	15-4435-01	15-4436-02	15-4437-03
3 x 10 mm	15-4435-01	15-4436-02	15-4437-03
4 x 10 mm	15-4435-01	15-4436-02	15-4437-03

NEURO SURGERY

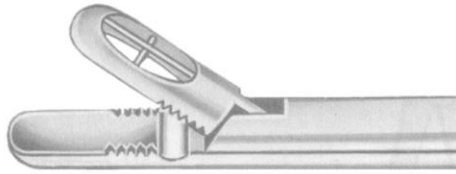

Serrated and Fenestrated Jaws



Width Of Jaw	Length Of Shaft			
mm	14 cm/5 1/2"	15-4438-01	15-4438-02	15-4438-03
	16 cm/6 1/4"	15-4439-01	15-4439-02	15-4439-03
2 x 12	14 cm/5 1/2"	15-4440-01	15-4440-02	15-4440-03
	16 cm/6 1/4"	15-4441-01	15-4441-02	15-4441-03
3 x 12	14 cm/5 1/2"	15-4442-01	15-4442-02	15-4442-03
	16 cm/6 1/4"	15-4443-01	15-4443-02	15-4443-03
4 x 14	14 cm/5 1/2"	15-4444-01	15-4444-02	15-4444-03
	16 cm/6 1/4"	15-4445-01	15-4445-02	15-4445-03
5 x 14	14 cm/5 1/2"	15-4446-01	15-4446-02	15-4446-03
	16 cm/6 1/4"	15-4447-01	15-4447-02	15-4447-03
6 x 16	14 cm/5 1/2"			
	16 cm/6 1/4"			

NEURO SURGERY

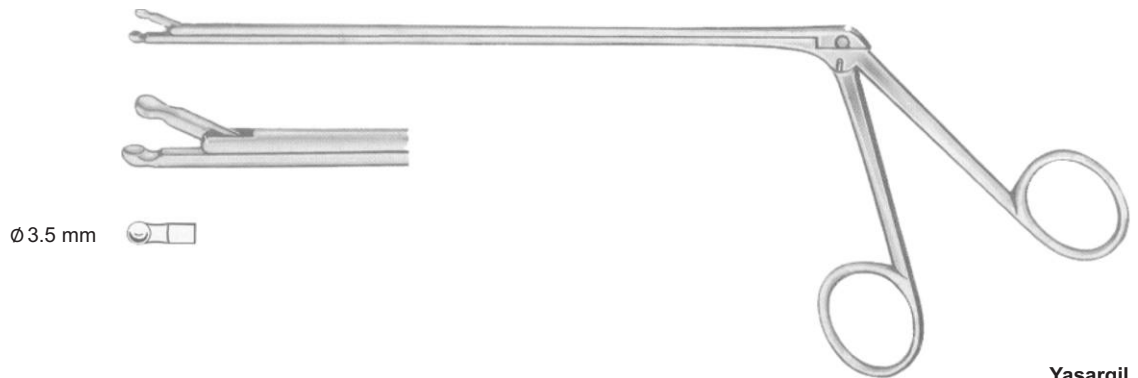

Ø 3.5 mm

Yasargil
15-4448-35
19.5 cm/7³/₄"



Ø 6.5 mm

Oldberg
15-4449-65
18 cm/7"

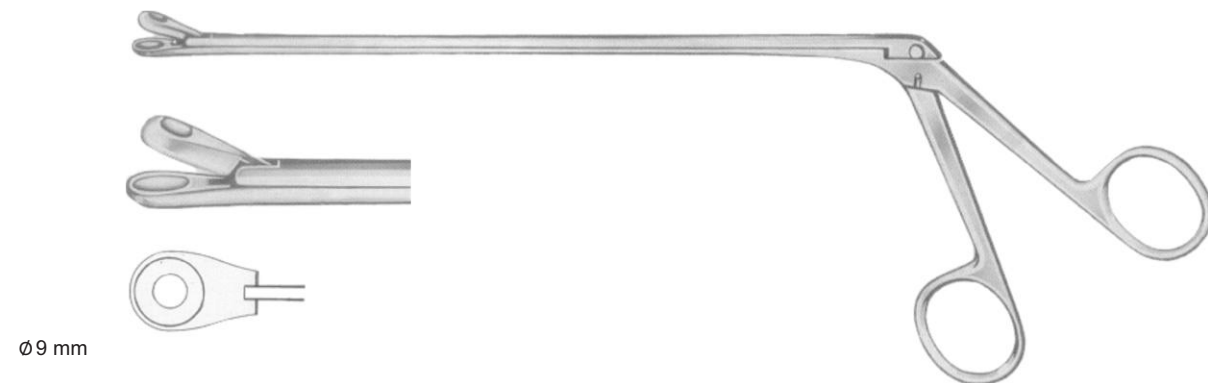

Ø 9 mm

Landolt
15-4450-90
21 cm/8¹/₄"
Tumor Grasping Forceps Blunt

NEURO SURGERY

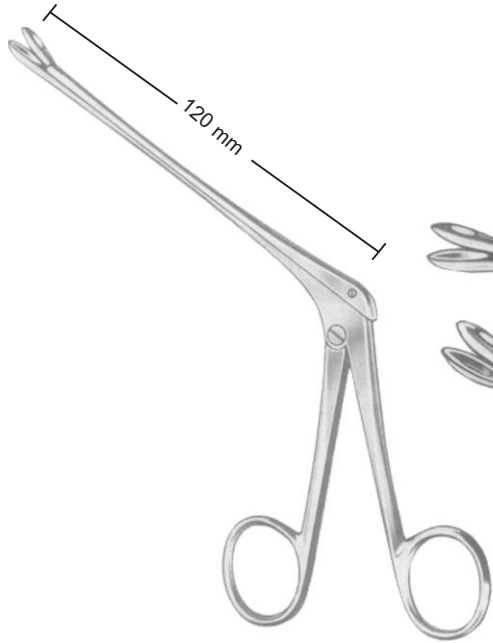

Weil-Blakesley



15-4451-01

15-4451-02

15-4451-03

15-4451-04

15-4451-05



15-4452-01

15-4452-02

15-4452-03

15-4452-04

15-4452-05



15-4453-01

15-4453-02

15-4453-03

15-4453-04

15-4453-05



15-4454-01

15-4454-02

15-4454-03

15-4454-04

15-4454-05

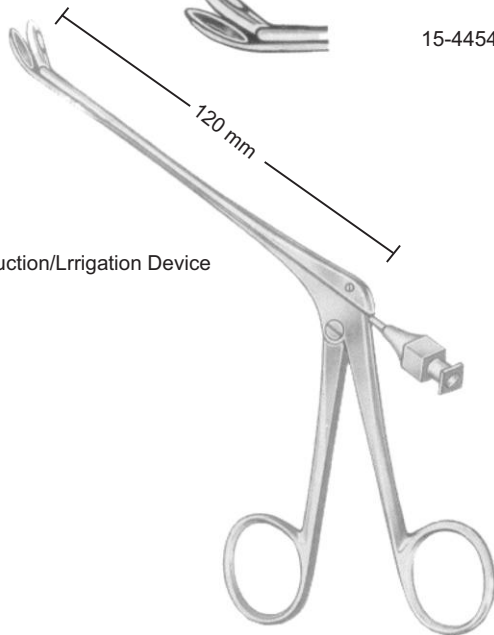

With Suction/Irrigation Device

Weil-Blakesley

NEURO SURGERY

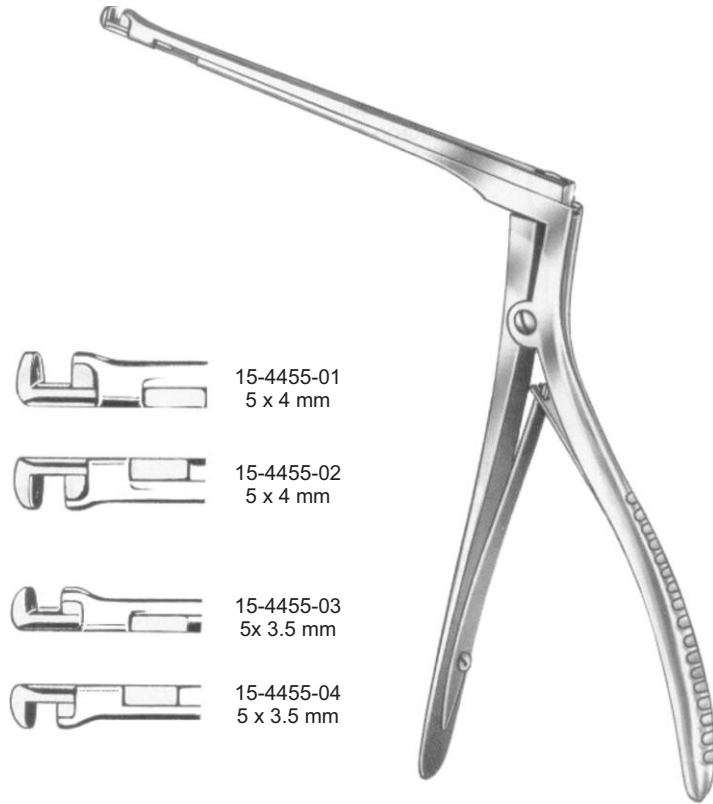

15-4455-01
5 x 4 mm



15-4455-02
5 x 4 mm



15-4455-03
5 x 3.5 mm



15-4455-04
5 x 3.5 mm

Hajek
(Hajek-Kofler)
14 cm/5½"

360° Turnable

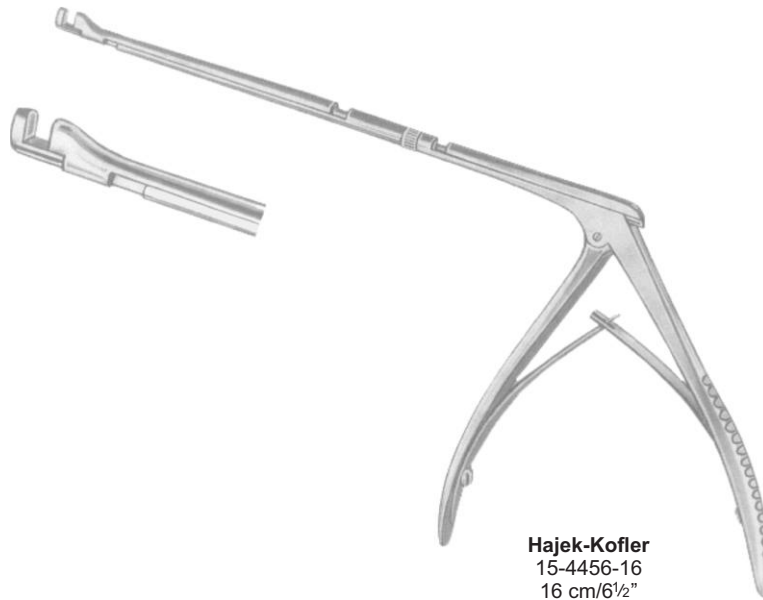

Hajek-Kofler
15-4456-16
16 cm/6½"

- EN** Ophthalmology
- DE** Ophthalmologie
- ES** Oftalmología

Page 389 to 419



OPHTHALMOLOGY



Weiss
Children 16-4501-07
7 cm/2¾"
Adults 16-4502-09
9 cm/3½"



Weiss
Children 16-4503-07
7 cm/2¾"
Adults 16-4504-09
9 cm/3½"

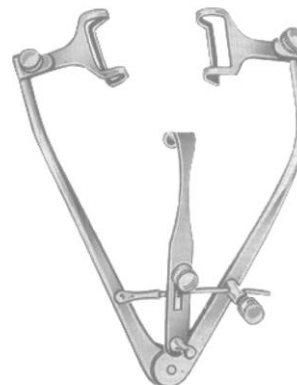

Park
16-4505-08
8 cm/3¼"

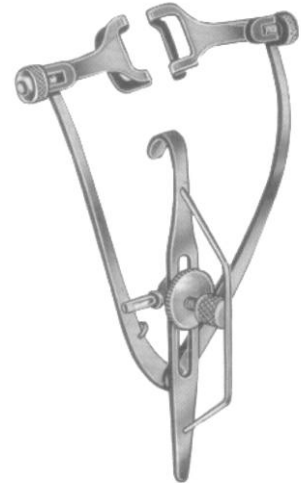

Park-Guyton
16-4506-08
8 cm/3¼"

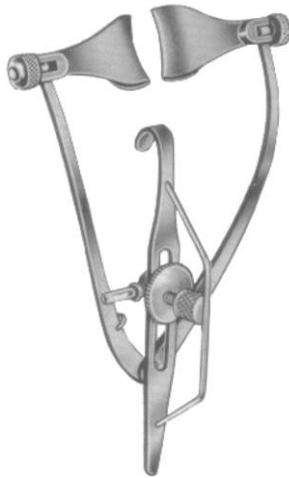

Park-Maumenee
16-4507-08
8 cm/3¼"



Barraquer (Colibri)
Children 16-4508-03
3 cm/1¼"
Adults 16-4509-04
4 cm/1½"



Bowman
16-4511-07
7 cm/2¾"



Sauer
16-4512-03
3 cm/1¼"



Barraquer
16-4510-04
4 cm/1½"



Goldstein
16-4513-03
3 cm/1¼"



Pley
16-4514-06
6 cm/2¼"

For left eye

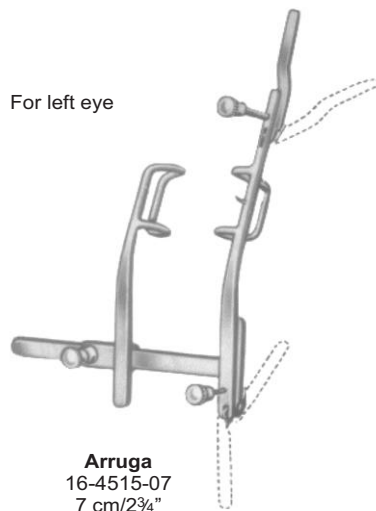

Arruga
16-4515-07
7 cm/2¾"

For right eye

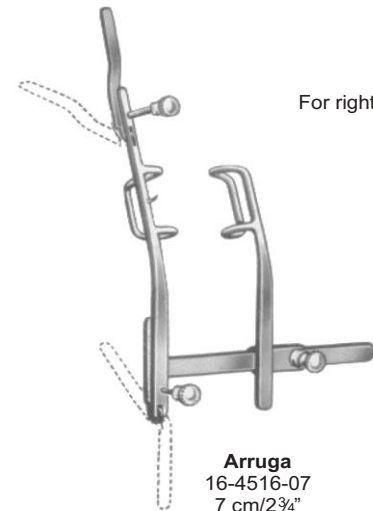

Arruga
16-4516-07
7 cm/2¾"

OPHTHALMOLOGY



Mellinger-Axenfeld
 16-4517-07
 7 cm/2 3/4"



Mellinger-Axenfeld
 16-4518-07
 7 cm/2 3/4"



Children
 16-4519-05
 5 cm/2 3/4"



Mellinger
 Adults
 16-4520-07
 7 cm/2 3/4"



Children
 16-4521-05
 5 cm/2"



Mellinger Beard Adults
 16-4522-07
 7 cm/2 3/4"



Knapp Clark
 16-4523-08
 8 cm/3 1/4"



Children
 16-4524-06
 6 cm/2 1/2"

Graefe Adults
 16-4525-09
 9 cm/3 1/2"



Lancaster
 16-4526-08
 8 cm/3 1/4"



Children
 16-4527-07
 7 cm/2 3/4"

Williams Adults
 16-4528-08
 8 cm/3 1/4"



Lister-Burch
 16-4529-08
 8 cm/3 1/4"



Weiss
 16-4530-08
 8 cm/3 1/4"



Murdock
 16-4531-05
 5 cm/2"



Mueller
 16-4532-07
 7 cm/2 3/4"



Critchett
 16-4533-06
 6 cm/2 1/2"



Castroviejo
 16-4534-08
 8 cm/3 1/4"

OPHTHALMOLOGY



Schepens
16-4535-13
13 cm/5"



Desmarres
16-4536-13
13 cm/5"



8 mm

Conway
16-4537-13
13 cm/5"



Desmarres
13 cm/5"

16-4538-12
12 mm

16-4538-14
14 mm

16-4538-16
16 mm

16-4538-18
18 mm

Lid plate



Jaeger
16-4539-11
11 cm/4 1/2"

OPHTHALMOLOGY

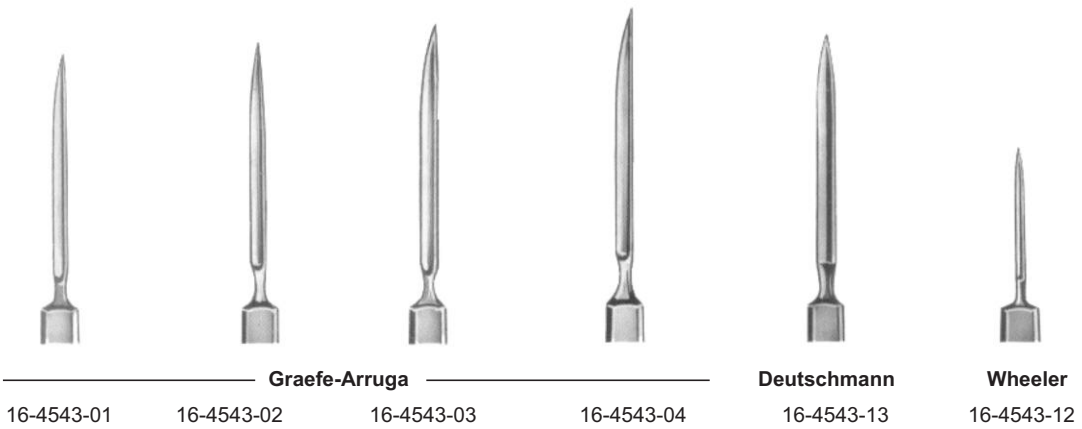
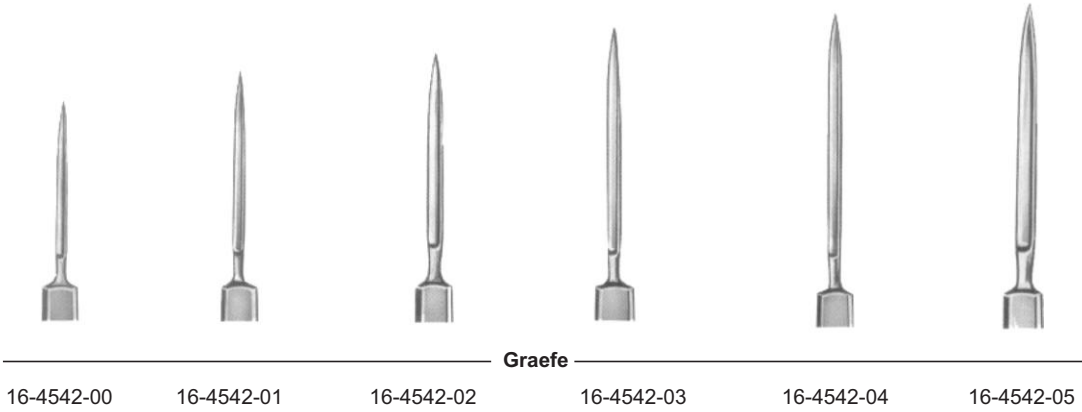
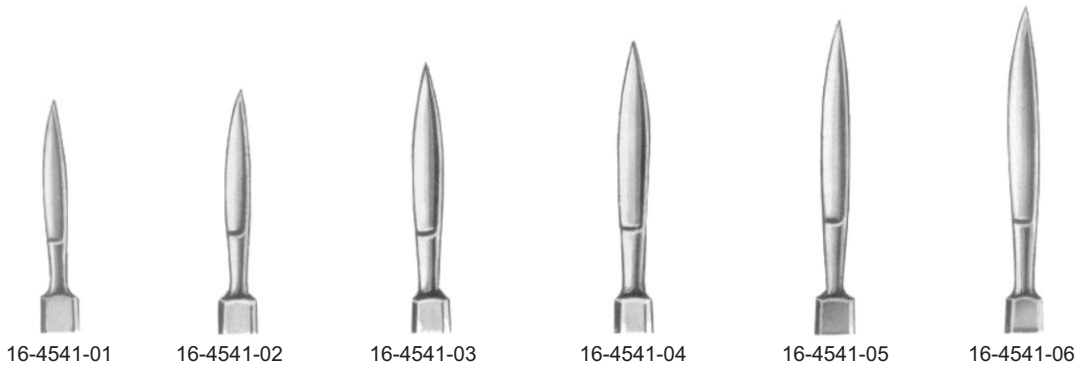
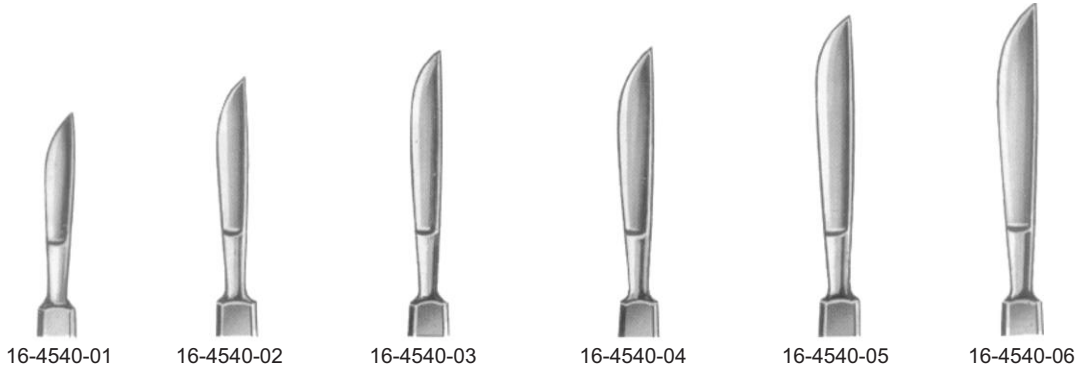

OPHTHALMOLOGY

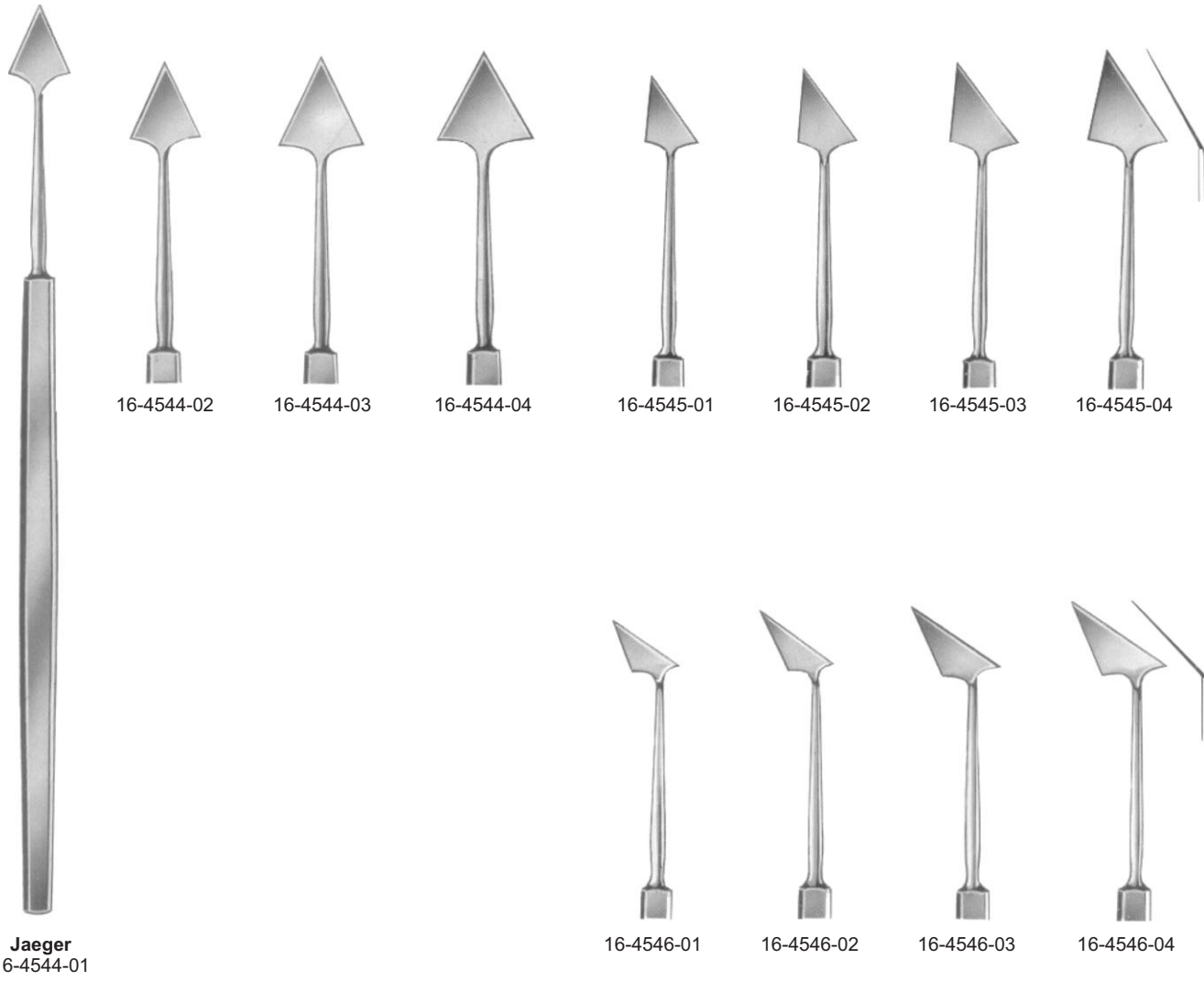

Jaeger
16-4544-01

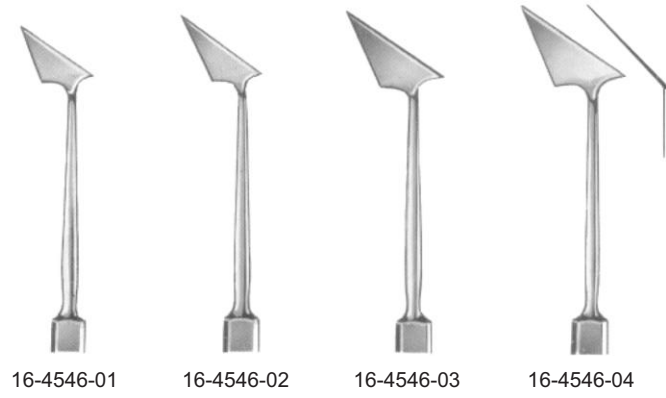

16-4546-01 16-4546-02 16-4546-03 16-4546-04

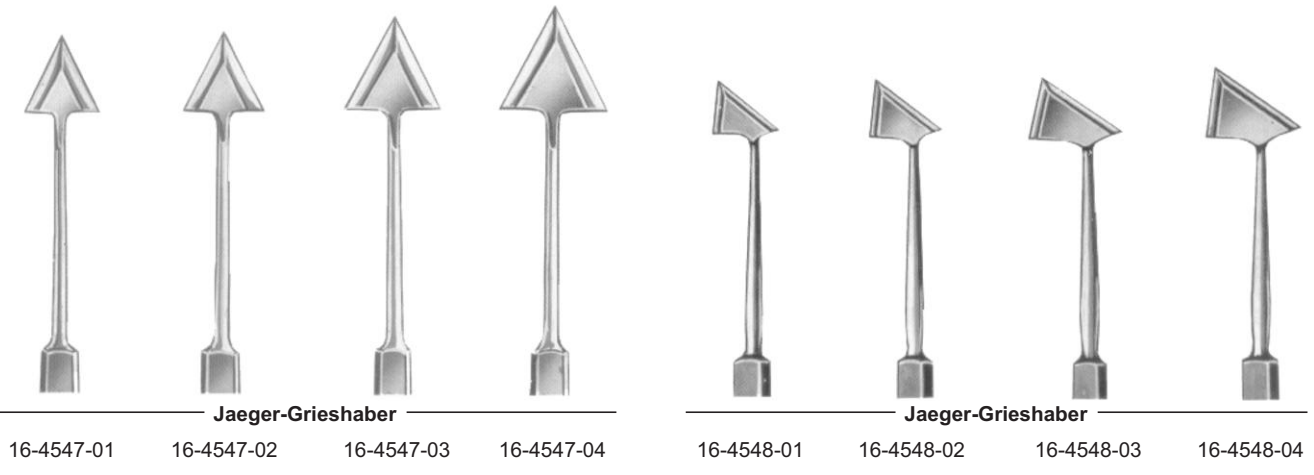

Jaeger-Grieshaber

Jaeger-Grieshaber

16-4547-01 16-4547-02 16-4547-03 16-4547-04 16-4548-01 16-4548-02 16-4548-03 16-4548-04

OPHTHALMOLOGY

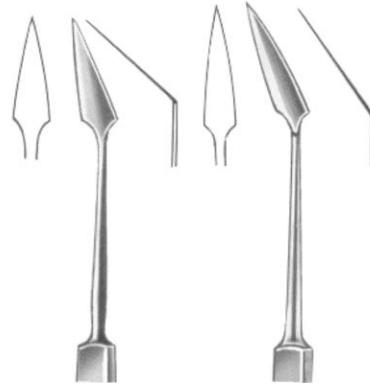
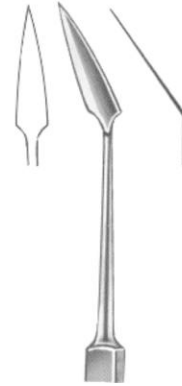
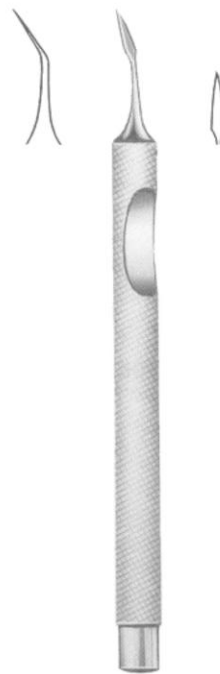
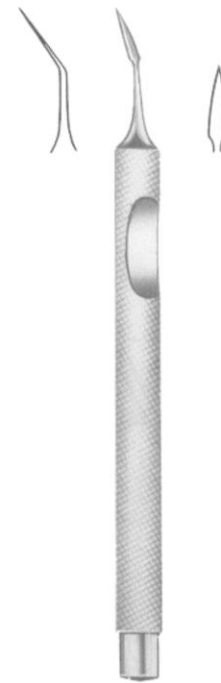
**Wessely-Grieshaber**16-4549-01
4 mm16-4549-02
5 mm16-4549-03
6 mm16-4549-04
7 mm**Wiener**
16-4550-13**Berens**
16-4551-13**Papst**
16-4552-13**Castroviejo**
16-4553-13**Castroviejo**
16-4554-01
9 cm/3½"**Castroviejo**
16-4555-02
9 cm/3½"**Castroviejo**
16-4556-03
9 cm/3½"

OPHTHALMOLOGY



Mod. Hamburg
16-4557-12



Graefe
16-4558-13



16-4559-01



Weber
16-4559-02



16-4559-03



Bowman
16-4560-04
0.4 mm



Bowman
16-4560-05
0.5 mm



Bowman
16-4560-06
0.6 mm



Bowman
16-4560-07
0.7 mm



Bowman
16-4560-08
0.8 mm

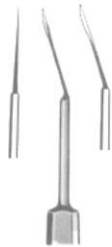

Left **Bowman** Right
16-4561-01 16-4561-02



16-4562-01



Knapp
16-4562-02



16-4562-03



16-4563-05
5 mm



Ziegler
16-4563-06
6 mm



16-4563-07
7 mm

OPHTHALMOLOGY



Dean
16-4564-13



Zigler
16-4565-11
3½ mm



Sato
16-4566-12



Sichel
16-4567-13



Graefe
16-4568-13



Graefe
16-4569-13



16-4570-01



Kuhnt
16-4571-02



16-4572-03



16-4573-04



Paton
16-4574-12

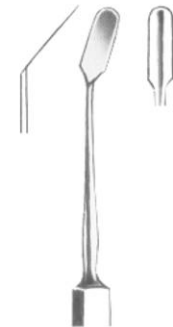

Elsching
16-4575-13



Took
16-4576-12



16-4577-01



Desmarres
16-4578-02



16-4579-03



Gill
16-4580-12

OPHTHALMOLOGY



Guthrie
16-4581-12



Guthrie
16-4582-13



Berens
16-4583-12



Knapp
Blunt
16-4584-13



Rollet
Sharp
16-4585-12



Rollet
16-4586-12



Fink
Blunt
16-4587-12



10.5 cm/4 1/4"

Right
16-4588-01

Left
16-4588-02



Knapp-Rollet
16-4589-02



16-4589-03



16-4589-04

Flexible

OPHTHALMOLOGY



Axenfeld

Sharp
16-4590-14

Blunt
16-4591-14



Axenfeld

Sharp
16-4592-14

Blunt
16-4593-14



Paul
16-4594-12



Sautter
16-4595-01



Sautter
16-4596-02



Sautter
16-4597-03



Arruga
16-4598-13



Stevens
16-4599-14



Stevens
16-4600-12



Graefe
16-4601-01



Graefe
16-4602-02



Graefe
16-4603-03



Wecker
16-4604-13



Wecker
16-4605-13



Stock
16-4606-13



Stock
16-4607-13



Culler
16-4608-13



Suker
16-4609-14

OPHTHALMOLOGY



Enucleation Scoops

Small
16-4610-16

Large
16-4610-20

Wells

Chalazion Curettes

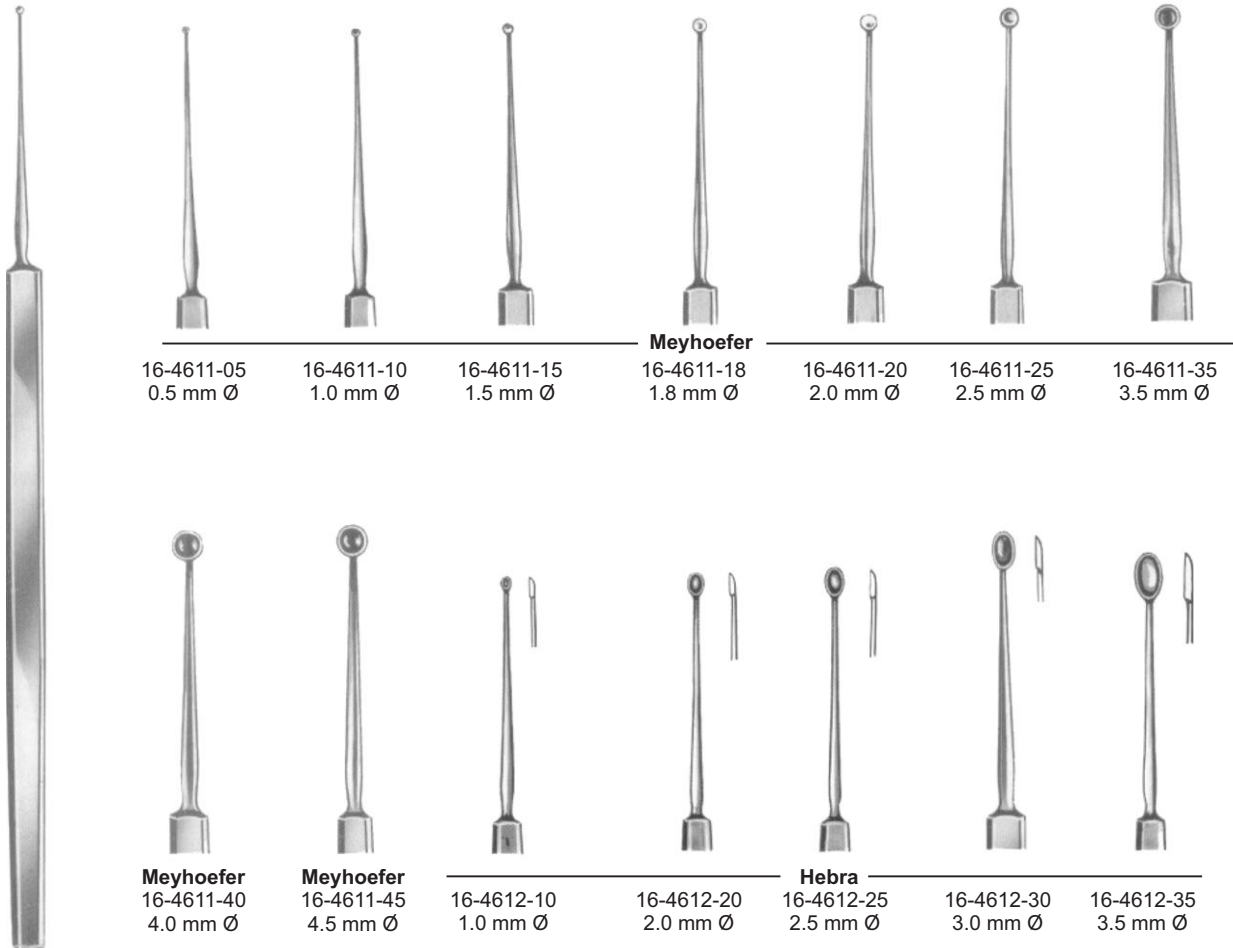

OPHTHALMOLOGY

Exenteration Scoops



16-4613-01 16-4613-02 **Bunge** 16-4613-03 16-4613-04 16-4613-05



Chalazion Curette, Double

Axenfeld
16-4614-13
13 cm/5"



Lachrymal Sac Dissector

Lang
16-4615-13
13 cm/5"

OPHTHALMOLOGY

Irrigating Cannulas

Straight



Binkhorst
16-4616-01
22 gauge

Right



Binkhorst
16-4617-02
22 gauge

Left



Binkhorst
16-4618-03
22 gauge



Bonn
16-4619-04
20 gauge



Bonn
16-4620-05
19 gauge

Probe Point

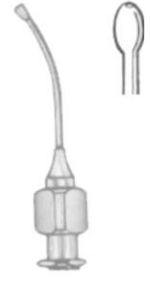

Hamburg
16-4621-06
23 gauge

Irrigation/Aspiration Cannulas



Simcoe
16-4622-01
23 gauge

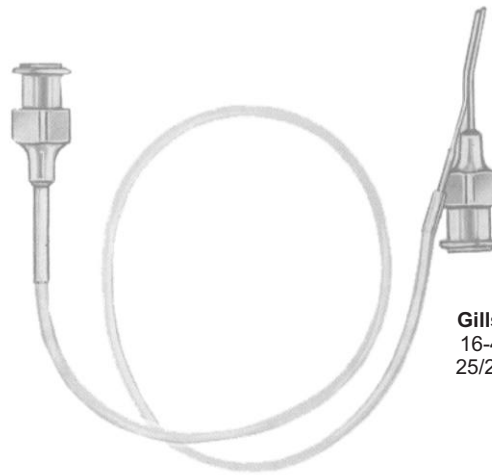

stotome Cannulas

Gills-Welsh
16-4623-02
25/23 gauge

Lens Manipulation Cannulas



Knolle-Kelmann
16-4624-01
22 gauge



Nevyas
16-4625-02
22 gauge



Kratz
16-4626-03
22 gauge



Freeman
16-4627-01
27 gauge

OPHTHALMOLOGY

Irrigating Vectis Cannulas



Cortex Aspiration Cannulas

Capsule Polishing Cannulas



OPHTHALMOLOGY



Castroviejo
16-4636-15



Castroviejo
16-4637-20
20 mm



Holth
16-4638-01



Haitz
16-4639-02



West
16-4640-16
16 cm/6 1/4"



West
16-4641-16
16 cm/6 1/4"

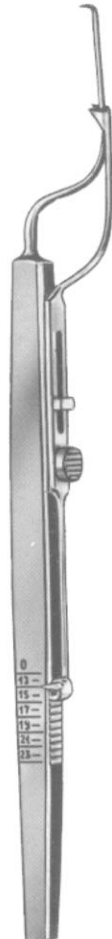

Connin-Amsler
16-4642-13
13 cm/5"



Wilder
16-4643-01



Wilder
16-4644-02



Wilder
16-4645-03

OPHTHALMOLOGY



16-4646-13 16-4647-13

Needle Only
16-4648-01

Chisel Only
16-4648-02

Gouge Only
16-4648-03



16-4649-13

Instrumentation for D. B. Kirby Operations



16-4650-10



Teeth

16-4651-10 1:2 Teeth
16-4652-10 2:3 Teeth



16-4653-10
1 : 2



Kirby
16-4654-10
10 cm/4"



Kirby
16-4655-10
10 cm/4"



16-4656-10



16-4657-10

OPHTHALMOLOGY



Tuebingen
16-4658-10
10 cm/4"



16-4659-08
8.5 cm/3 1/2"



Paufigue
16-4660-10
10 cm/4"



Barraquer
16-4661-10
10.5 cm/4 1/4"



McPherson
16-4662-10
10 cm/4"



McPherson
16-4663-07
7.5 cm/3"

OPHTHALMOLOGY



McCullough
 16-4664-09
 9.5 cm/3 3/4"



McCullough
 16-4665-09
 9.5 cm/3 3/4"



Bonaccoito
 16-4666-10
 10 cm/4"



Bonaccoito
 16-4667-10
 10 cm/4"



16-4668-11
 11 cm/4 1/2"



11 cm/4 1/2"



16-4669-11
 1 : 2



16-4670-11
 2 : 3



16-4671-01



16-4672-02

Nugent
 10 cm/4"

OPHTHALMOLOGY

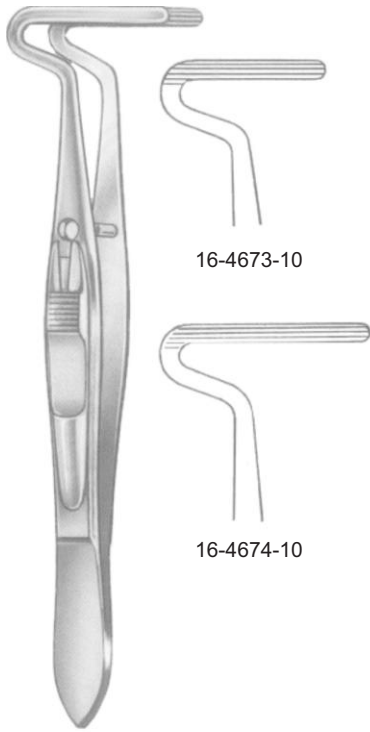

Berke
10 cm/4"



Blascovics
16-4675-09
9 cm/3 1/2"

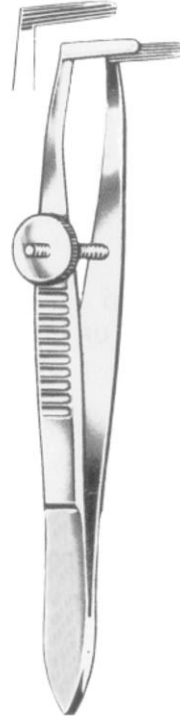

Blascovics
16-4676-09
9 cm/3 1/2"



Worth
16-4677-10
10 cm/4"

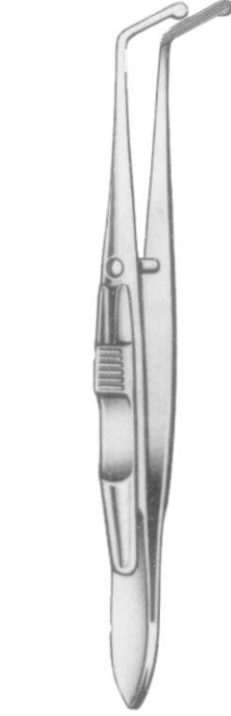

Worth
16-4678-10
10 cm/4"



Jameson
16-4679-10
10 cm/4"

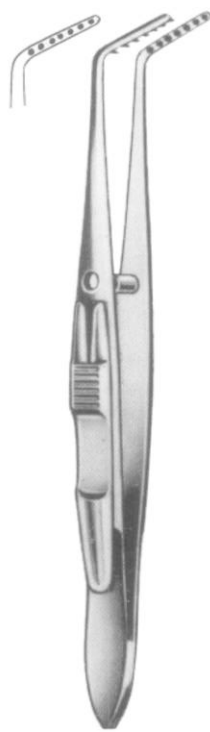

Jameson
16-4680-10
10 cm/4"



Prince
16-4681-10
10 cm/4"



Prince
16-4682-10
10 cm/4"

OPHTHALMOLOGY



Snellen
 16-4683-10
 10 cm/4"



Snellen
 16-4684-10
 10 cm/4"



Erhardt
 16-4685-09
 9 cm/3 1/2"

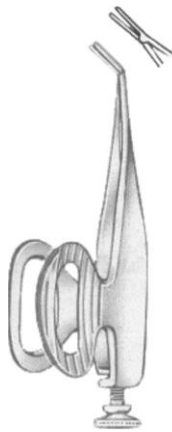

Barraquer
 16-4686-05
 5.5 cm/2 1/4"

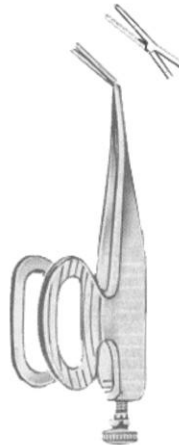

Barraquer
 16-4687-07
 5.5 cm/2 1/4"



Barraquer
 16-4688-10
 5.5 cm/2 1/4"

OPHTHALMOLOGY

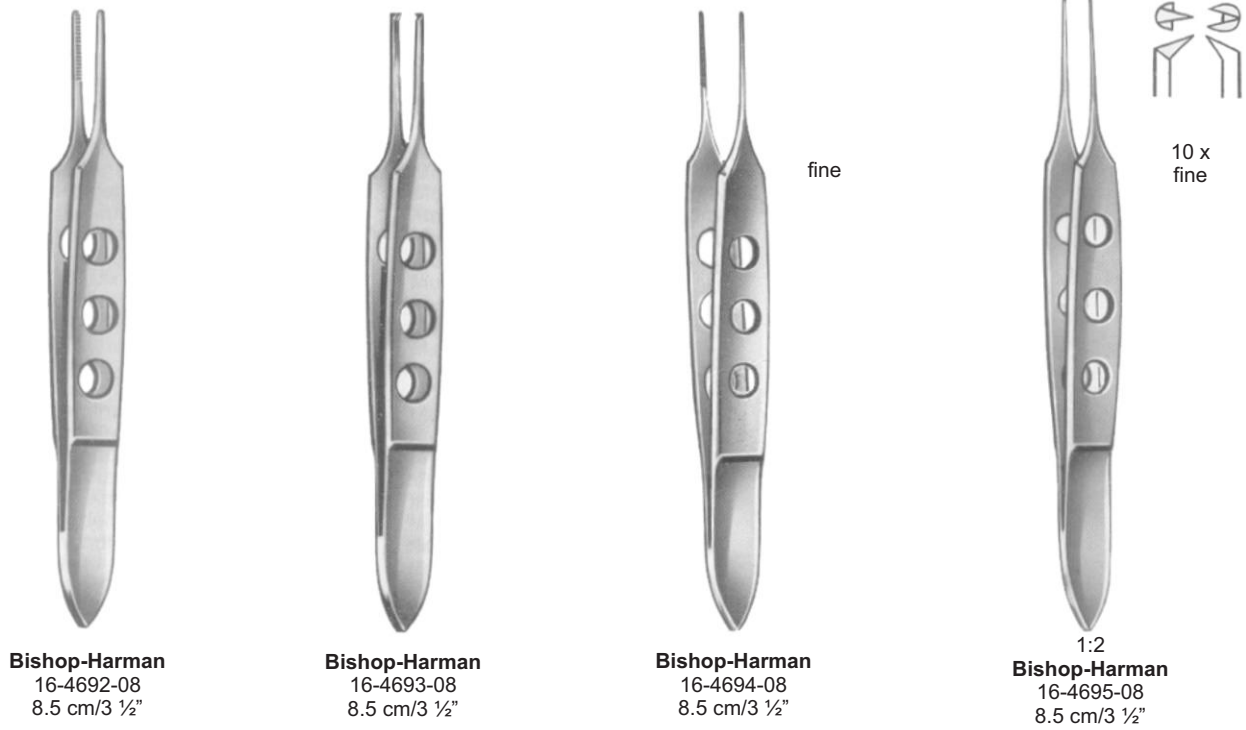
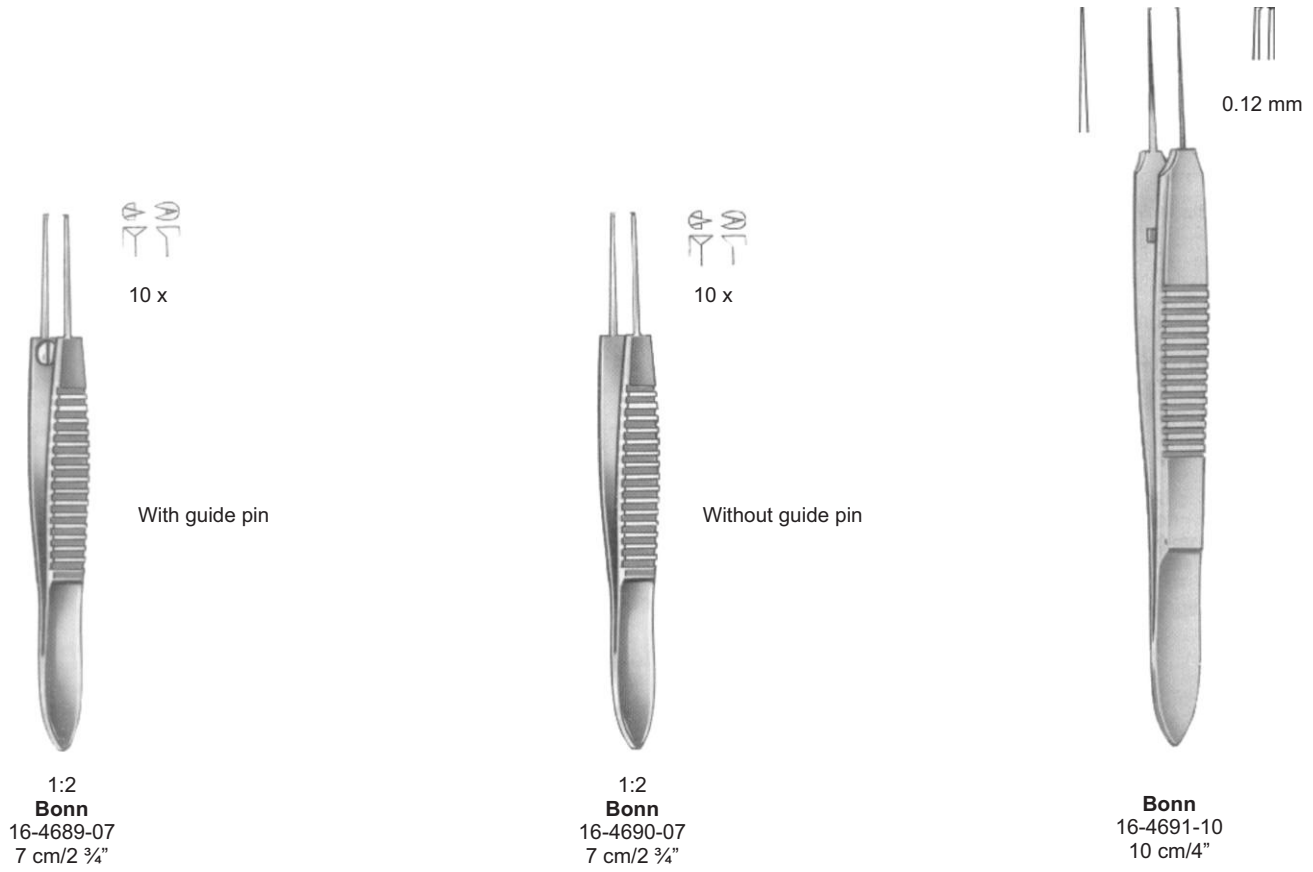

OPHTHALMOLOGY



Graefe
10 cm/4"



16-4696-10



16-4697-10



16-4698-10



16-4699-10



16-4700-10



16-4701-10

Conjunctival forceps



Stevens
10.5 cm/4¼"



16-4702-10



16-4703-10



16-4704-10



O'Connor
16-4708-10
10 cm/4"



16-4705-10



16-4706-10



16-4707-10



Stevens
16-4709-11
11 cm/4½"



Stevens
16-4710-11
11 cm/4½"

OPHTHALMOLOGY

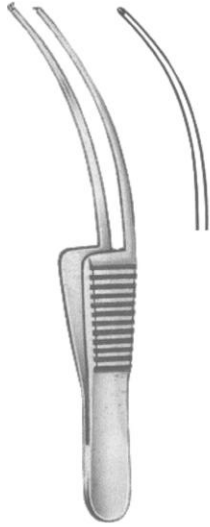

Fischer
16-4711-07
7 cm/2 3/4"

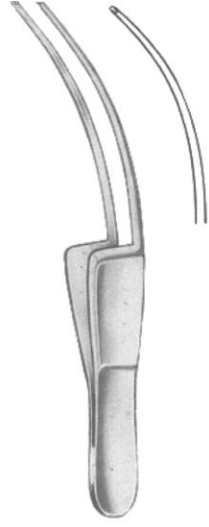

Fischer-Arit
16-4712-07
7 cm/2 3/4"



Hess
16-4713-07
7 cm/2 3/4"



Hess
16-4714-07
7 cm/2 3/4"



Smooth **Chandler** Serrated
16-4715-01 7 cm/2 3/4" 16-4716-02



Fuchs
16-4717-07
7 cm/2 3/4"



Gill-Hess
16-4718-07
7.5 cm/3"



Gill-Hess Teeth Below
16-4719-07 7.5 cm/3"
Teeth on side 16-4720-07

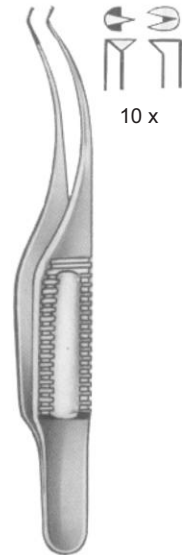

Barraquer-Katzin
(Colibri)
16-4721-07
7 cm/2 3/4"

OPHTHALMOLOGY



Fuchs
 16-4722-07
 7 cm/2 ¾"

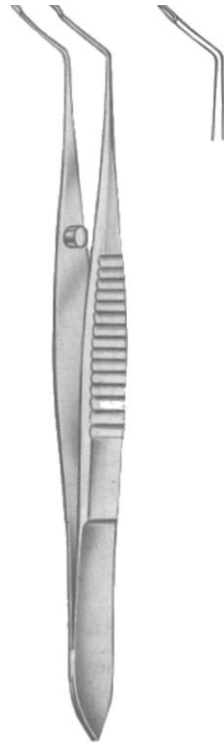

Kalt
 16-4723-10
 10 cm/4"



Terson
 16-4724-09
 9.5 cm/3 ¾"



Arruga-Nizetic
 16-4725-10
 10 cm/4"



Castroviejo
 16-4726-10
 10 cm/4"



Castroviejo
 16-4727-10
 10 cm/4"



Elschnig
 16-4728-10
 10 cm/4"

For Len Implantation



Binkhorst
 16-4729-07
 7 cm/2 ¾"



Arruga
 16-4730-09
 9.5 cm/3 ¾"



Arruga
 16-4731-09
 9.5 cm/3 ¾"

OPHTHALMOLOGY



Knapp
16-4732-11
11 cm/4¼"



Ayer
16-4733-09
9 cm/3½"



Ayer
16-4734-09
9 cm/3½"



Lambert
16-4735-09
9 cm/3½"



Desmarres
9 cm/3½"



16-4736-01



16-4737-02



16-4738-03

OPHTHALMOLOGY



Fig. 1

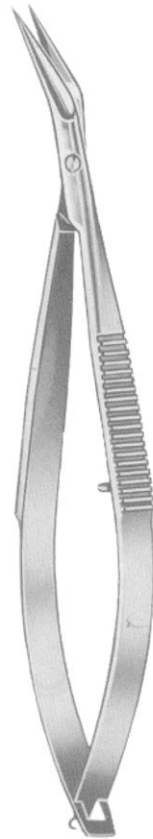

Fig. 2

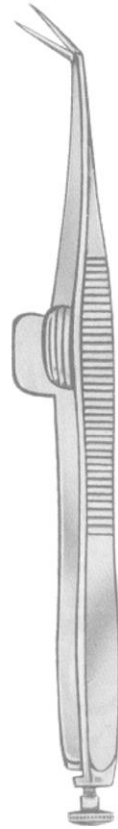

Fig. 3

Noyes
 Fig.1 16-4739-01
 Fig.2 16-4739-02
 Fig.3 16-4739-03
 12 cm/4 ¾"



Noyes
 16-4740-12
 12 cm/4 ¾"



Wecker
 16-4741-01
 11.5 cm/4½"



16-4741-01



16-4742-02



Barraquer
 16-4743-05
 5.5 cm/2 ¼"

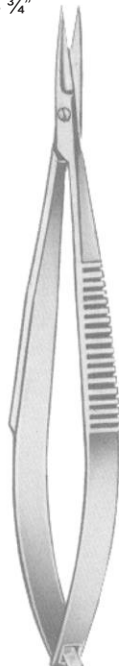

16-4744-09
 9 cm/3 ½"



16-4745-09



16-4746-09



16-4747-09



16-4748-09



16-4749-09

OPHTHALMOLOGY

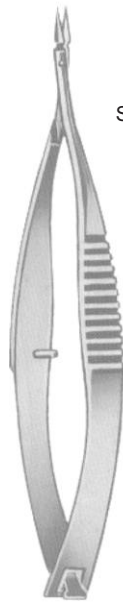

Straight

Vannas
16-4750-08
8 cm/3 1/4"

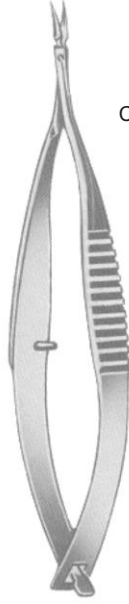

Curved

Vannas
16-4751-08
8 cm/3 1/4"

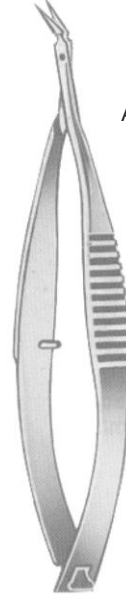

Angular

Vannas
16-4752-08
8 cm/3 1/4"

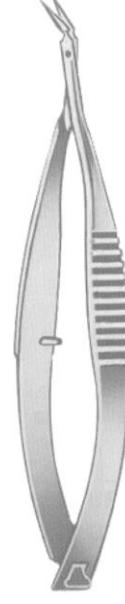

Vannas
16-4753-08
8 cm/3 1/4"

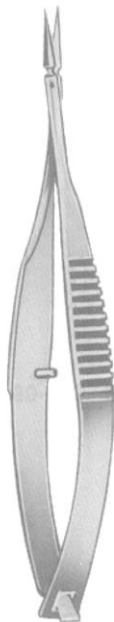

Straight

16-4754-08
8.5 cm/3 1/4"

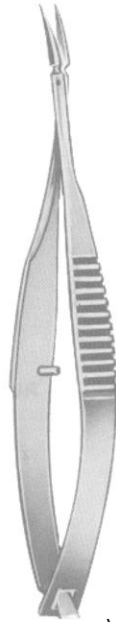

Curved

16-4755-08
8.5 cm/3 1/4"

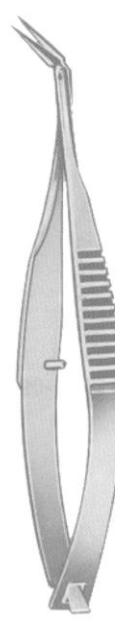

Angular

16-4756-08
8.5 cm/3 1/4"

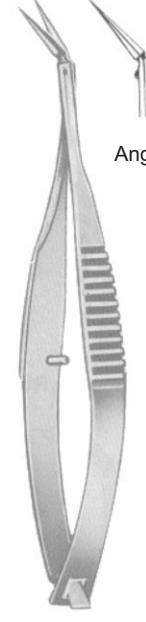

Angular

16-4757-08
8.5 cm/3 1/4"

Vannas Mod, Tubingen

OPHTHALMOLOGY



16-4758-10
10 cm/4"



16-4759-10
10 cm/4"



Castroviejo
16-4760-10
10 cm/4"



Castroviejo
16-4761-10
10 cm/4"



Aebli
16-4762-10
10 cm/4"

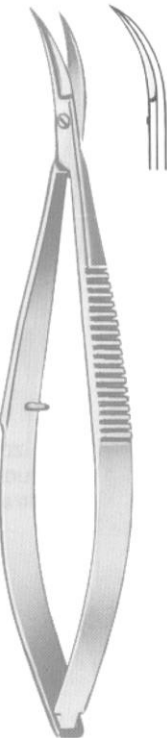

Castroviejo
16-4763-10
10 cm/4"

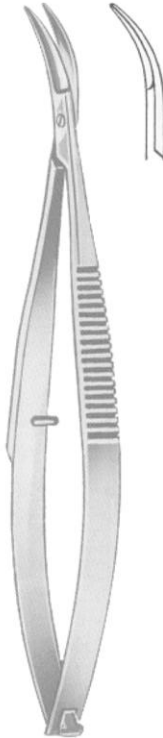

Castroviejo
16-4764-10
10 cm/4"

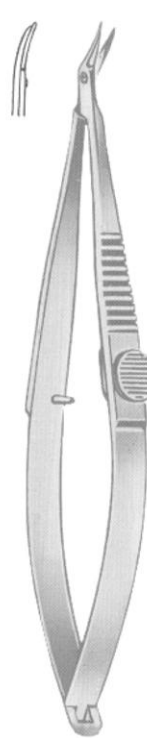

Troutman-Barraquer
16-4765-10
10 cm/4"

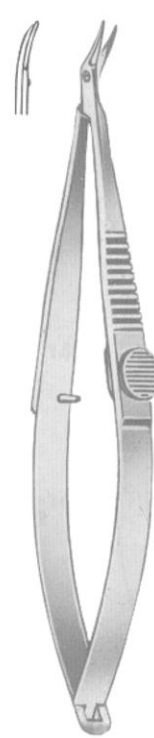

Troutman-Barraquer
16-4766-10
10 cm/4"

OPHTHALMOLOGY

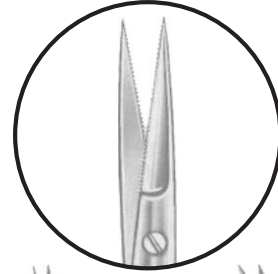

Saw Edge

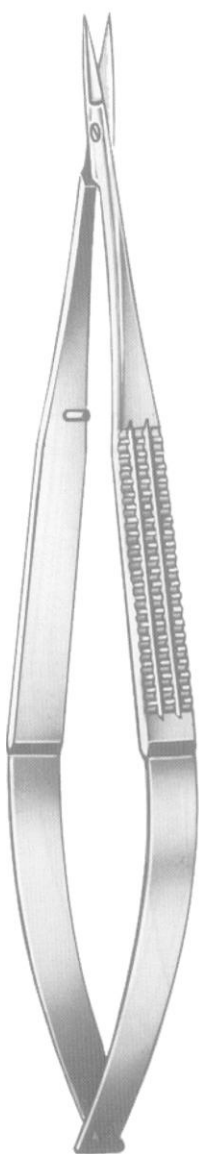

Straight
16-4767-16
16cm/6 1/4"

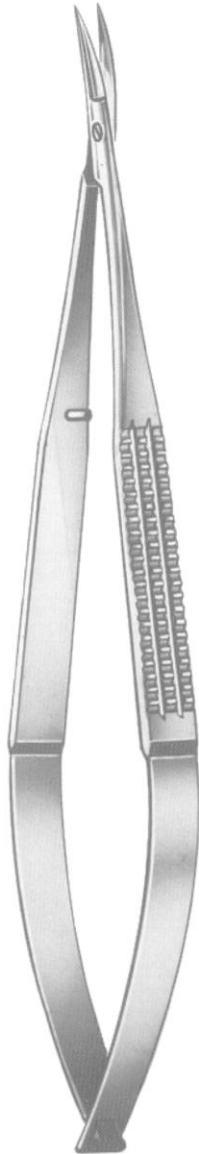

Curved
16-4768-16
16cm/6 1/4"

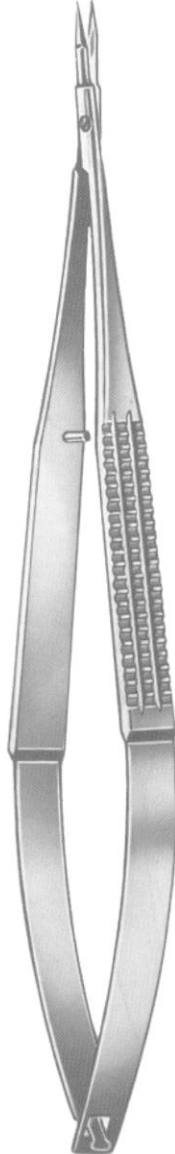

Straight
16-4769-16
16cm/6 1/4"

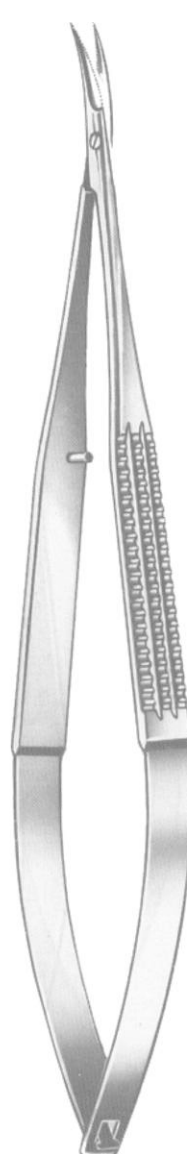

Curved
16-4770-16
16cm/6 1/4"

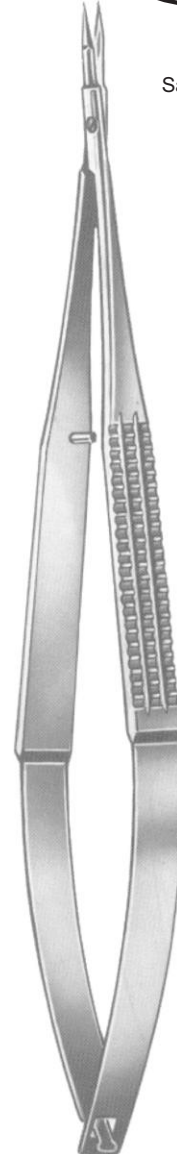

Millesi
Straight
16-4771-16
16cm/6 1/4"

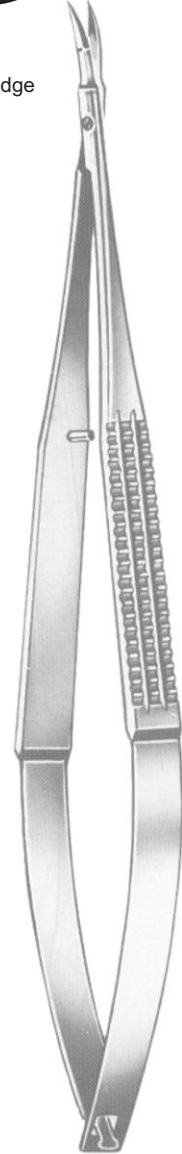

Millesi
Curved
16-4772-16
16cm/6 1/4"

OPHTHALMOLOGY



Straight
 16-4773-18
 18.5cm/7 ¼"

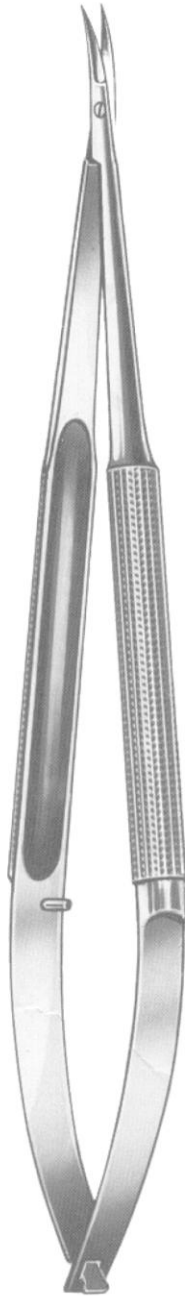

Curved
 16-4774-18
 18.5cm/7 ¼"

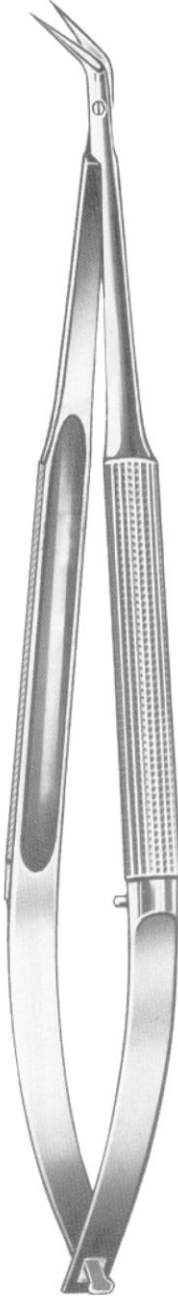

Angular
 16-4775-18
 18.5cm/7 ¼"



Straight
 16-4776-23
 23cm/9"

OPHTHALMOLOGY

Dissecting Scissors

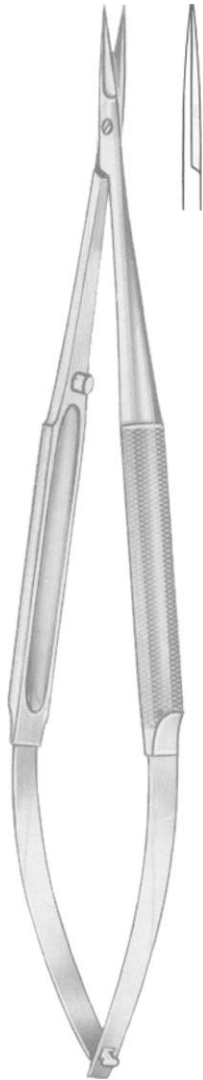

Straight
16-4777-14
14.5cm/5 3/4"

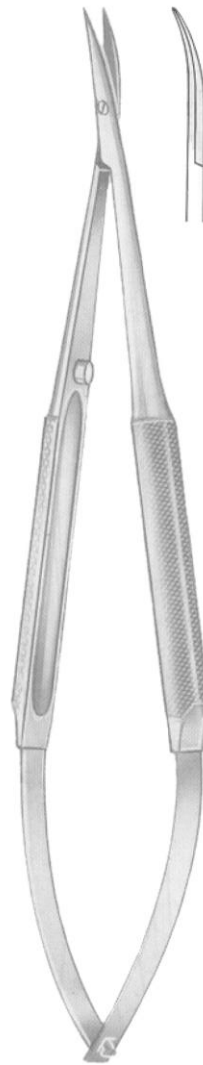

Curved
16-4778-14
14.5cm/5 3/4"



Curved
16-4779-14
14.5cm/5 3/4"

EN Otolology

DE Otologie

ES Otología

Page 420 to 437



OTOLOGY

Ø=Inside Dia



Troltsch
For Babies

- 17-4801-01 1.5 mm Ø
- 17-4801-02 2.5 mm Ø
- 17-4801-03 3.5 mm Ø

17-4801-30
Set of 3

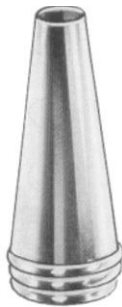

Troltsch
For Adults

- 17-4802-04 4.0 mm Ø
- 17-4802-05 5.0 mm Ø
- 17-4802-06 6.0 mm Ø
- 17-4802-07 7.0 mm Ø

17-4802-30 17-4802-40
Set of 3 Set of 4



Politzer

- 17-4803-01 2.0 mm Ø
- 17-4803-02 3.0 mm Ø
- 17-4803-03 4.0 mm Ø

17-4803-30
Set of 3



Erhard
For Adults

- 17-4804-01 3.0 mm Ø
- 17-4804-02 4.0 mm Ø
- 17-4804-03 5.0 mm Ø
- 17-4804-04 6.0 mm Ø

17-4804-30 17-4804-40
Set of 3 Set of 4



Hartmann
For Babies

17-4805-01 2.0 mm Ø

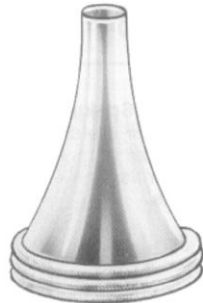

Hartmann
For Children

- 17-4806-02 3.0 mm Ø
- 17-4806-03 4.0 mm Ø
- 17-4806-04 5.5 mm Ø

17-4806-30
Set of 3



Hartmann
For Adults

- 17-4807-03 4.0 mm Ø
- 17-4807-04 5.5 mm Ø
- 17-4807-05 6.5 mm Ø
- 17-4807-06 7.5 mm Ø

17-4807-30 17-4807-40
Set of 3 Set of 4



Toynbee
For Adults

- 17-4808-01 4.5 mm Ø
- 17-4808-02 5.5 mm Ø
- 17-4808-03 6.5 mm Ø
- 17-4808-04 7.5 mm Ø

17-4808-30 17-4808-40
Set of 3 Set of 4

Alu Black



17-4809-60
Set of 6

Ø=Inside Dia

- 17-4809-01 4.5 x 5.5 mm Ø
- 17-4809-02 5.5 x 6.5 mm Ø
- 17-4809-03 6.5 x 7.5 mm Ø
- 17-4809-04 7.5 x 8.5 mm Ø
- 17-4809-05 8.5 x 9.5 mm Ø
- 17-4809-06 9.5 x 10.5 mm Ø

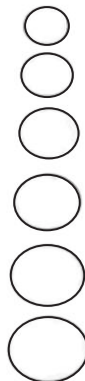

Gruber

17-4810-30 17-4810-40 17-4811-40 17-4811-40
Set of 3 Set of 4 Set of 3 Set of 4



- 17-4810-01 3 mm Ø
- 17-4810-02 4 mm Ø
- 17-4810-03 5 mm Ø
- 17-4810-04 6 mm Ø



- 17-4811-01 3 mm Ø
- 17-4811-02 4 mm Ø
- 17-4811-03 5 mm Ø
- 17-4811-04 6 mm Ø

OTOLOGY



Hartmann
 17-4812-40
 Set of 4

- Black
- 17-4812-01 3.0 mm Ø
 - 17-4812-02 4.0 mm Ø
 - 17-4812-03 5.0 mm Ø
 - 17-4812-04 7.0 mm Ø

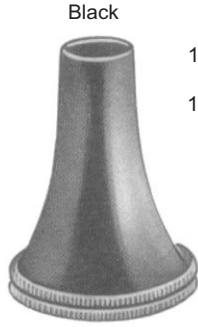

Hartmann
 17-4813-20
 Set of 2

- Black
- 17-4813-05 9.0 mm Ø
 - 17-4813-06 11.0 mm Ø



17-4814-01



17-4814-02
 17-4814-01 4.2 x 3.8 mm
 17-4814-02 5.5 x 3.8 mm
 17-4814-03 6.5 x 3.8 mm
 17-4814-30
 Set of 3



17-4814-03



17-4815-01



17-4815-02



17-4815-03

- 17-4815-01 4.2 mm
- 17-4815-02 5.5 mm
- 17-4815-03 6.5 mm
- 17-4815-30
 Set of 3

- 17-4816-03 3.5 mm Ø
- 17-4816-04 4.5 mm Ø
- 17-4816-05 5.5 mm Ø
- 17-4816-06 6.5 mm Ø

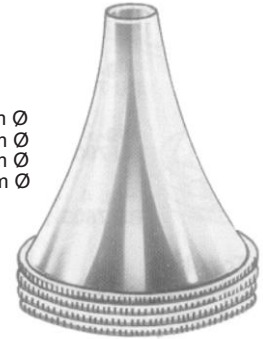

Bouillon
 17-4816-40
 Set of 4



Turmakin Speculum
 Black finish (slot)

A= Distal tip diameter
 B= Distal slot width
 C= Proximal slot width

- 17-4817-01 No. 1 A=3mm B=2.5mm C=4mm
- 17-4817-02 No. 2 A=4.5mm B=3mm C=5mm
- 17-4817-03 No. 3 A=6.5mm B=3mm C=5mm
- 17-4817-04 No. 4 A=7mm B=3mm C=5mm
- 17-4817-05 No. 5 A=7.5mm B=3.5mm C=7mm
- 17-4817-06 No. 6 A=8mm B=4mm C=8mm
- 17-4817-07 No. 7 A=8.5mm B=4.5mm C=9mm
- 17-4817-08 No. 8 A=9mm B=5mm C=10mm
- 17-4817-09 No. 9 A=11mm B=6mm C=11mm



Gruber Speculum
 Black finish (round)
 17-4818-03 3mm
 17-4818-04 4mm
 17-4818-05 5mm
 17-4818-06 6mm

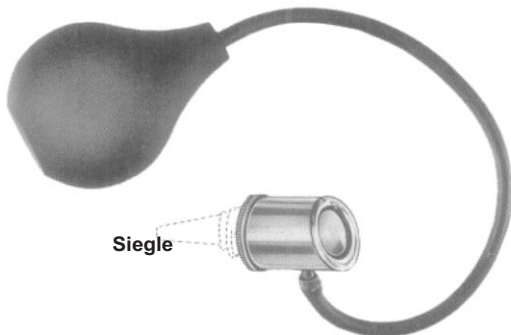

Siegler



Otoscope with 3 ear specula and rubber tube with bulb
 17-4819-00

OTOLOGY

Tuning Forks



Hartmann



Lucae



French
Hartmann



Lucae
C 128



Hartmann
C 128

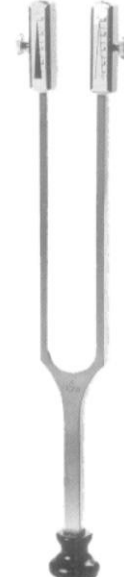

Rydel-Seiffer
17-4825-00
C 64/C 128

16			17-4822-16
32			17-4822-32
64			17-4822-01
128	17-4820-00	17-4821-00	17-4822-02
256	17-4820-01	17-4821-01	17-4822-03
512	17-4820-02	17-4821-02	
1024	17-4820-03	17-4821-03	
2048	17-4820-04	17-4821-04	
4096	17-4820-05	17-4821-05	

Variable up to h (Engl. B)
17-4823-00 17-4824-00

With Clamps = C 64
Without Clamps = C 128

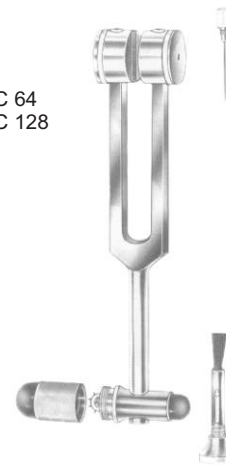

Tuning Fork for neurological examination, with percussion hammer, pin wheel, brush and needle
17-4826-00



17-4827-01
C 64

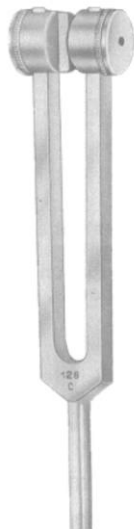

17-4827-02
C 128



17-4827-03
C 256



17-4827-04
C 512



17-4827-05
C 1024



17-4827-06
C 2048



17-4827-07
C 4096

OTOLOGY

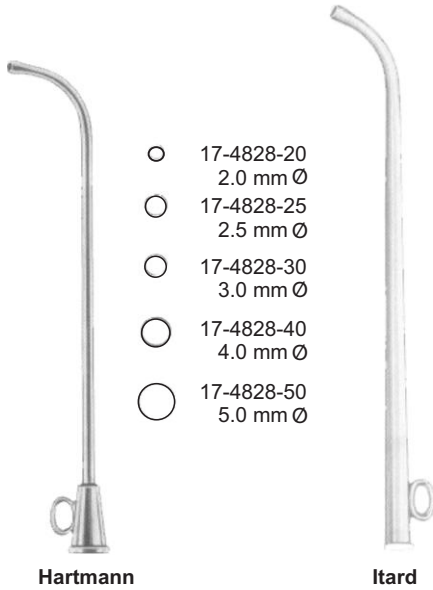

- 17-4828-20
2.0 mm Ø
- 17-4828-25
2.5 mm Ø
- 17-4828-30
3.0 mm Ø
- 17-4828-40
4.0 mm Ø
- 17-4828-50
5.0 mm Ø

- 17-4829-30
3 mm Ø
- 17-4829-35
3.5 mm Ø
- 17-4829-40
4 mm Ø
- 17-4829-45
4.5 mm Ø
- 17-4829-50
5 mm Ø

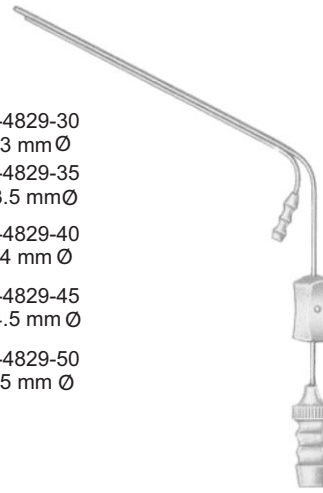

House
 17-4830-09 0.9 mm Ø
 17-4830-12 1.2 mm Ø
 17-4830-15 1.5 mm Ø



Baron (Schucknecht)
 17-4831-01 1.0 x 75 mm
 17-4831-02 1.5 x 75 mm
 17-4831-03 2.0 x 75 mm

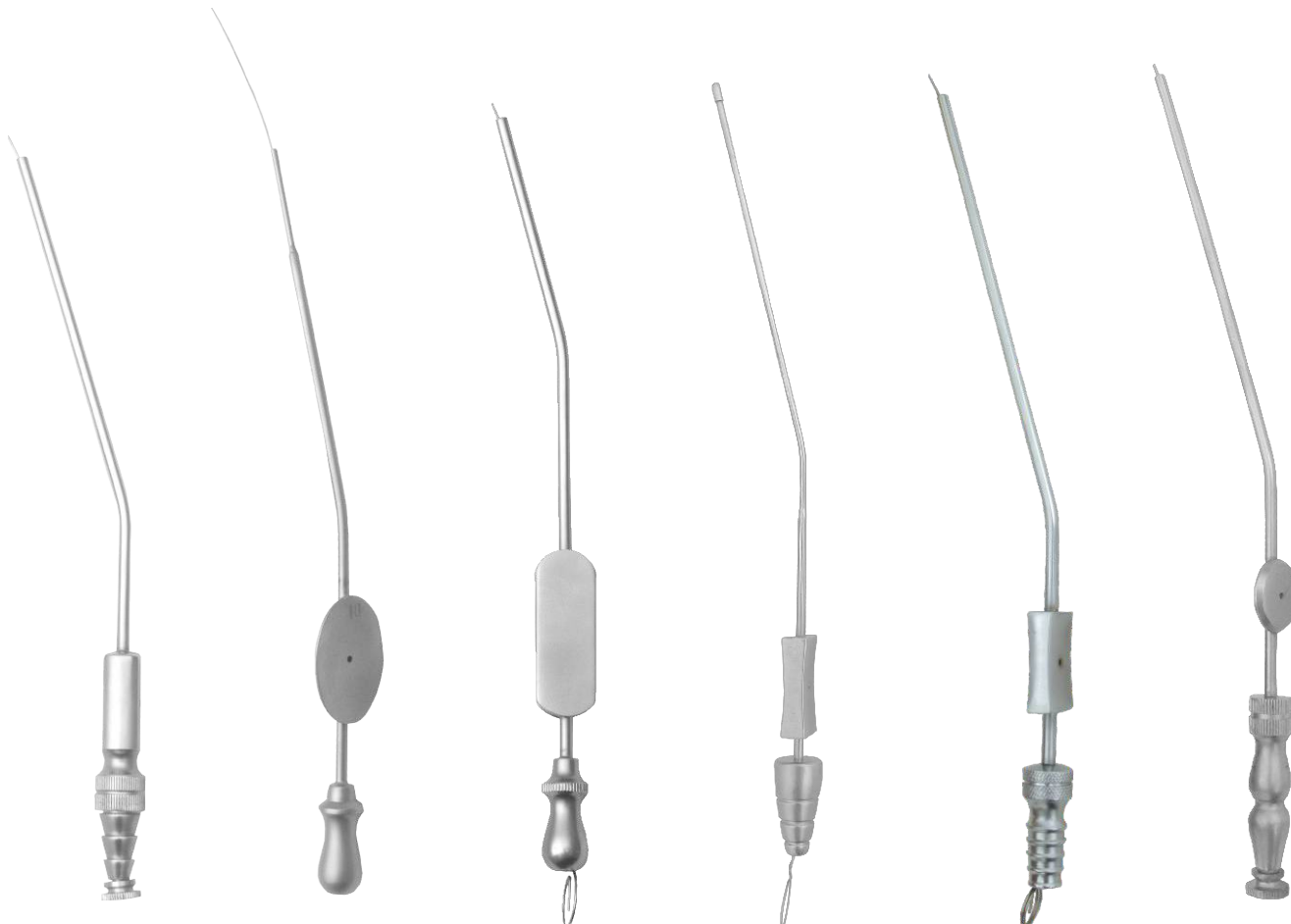

Adson Frazier Suction Tube
 with stilette
 17-4832-02
 2 x 180 mm
 17-4832-03
 3 x 180 mm

Schucknecht Suction Tube
 with stilette
 17-4833-18 swg 18
 17-4833-20 swg 20
 17-4833-22 swg 22
 17-4833-24 swg 24

Zoellner Suction Tube
 with stilette
 length 150 mm
 17-4834-15

Firth Suction Tube
 rounded tip, with stilette
 17-4835-70
 70 x 80 mm
 17-4835-80
 80 x 90 mm

Lempert Suction Tube
 with stilette
 17-4836-06
 Fig. 6, 2mm
 17-4836-09
 Fig. 9, 3mm
 length 200 mm

Fraizer Suction Tube
 with stilette
 17-4837-02
 Dia 2 mm
 17-4837-03
 Dia 3 mm
 length 200 mm

OTOTOLOGY



Krause
17-4838-16
16 cm/6 1/4"



Krause-Voss
17-4839-16
16 cm/6 1/4"



Lange-Wilde
17-4840-16
16 cm/6 1/4"



Package of 1 dozen each

	mm Ø
17-4841-02	0.2
17-4841-03	0.3

Ear Dressing Forceps



**Troeltsch
(Wilde)**



Troeltsch



Lucae



Lucae



Jansen

Cm	In	Troeltsch (Wilde)	Troeltsch	Lucae	Lucae	Jansen
11.0	4 1/4"	17-4842-11				
12.0	4 3/4"	17-4842-12	17-4843-12		17-4845-14	
14.0	5 1/2"	17-4842-14		17-4844-14		
15.0	6"	17-4842-15				
16.0	6 1/4"					17-4846-16
18.0	7"					17-4846-18
20.0	8"					17-4846-20

OTOLOGY



Okonogto
 17-4847-16
 16 cm/6¼"



Littauer
 17-4848-12
 12 cm/4¾"



Hartmann
 17-4849-12
 12 cm/4¾"



Hartmann
 17-4850-14
 14 cm/5½"

Standard Pattern

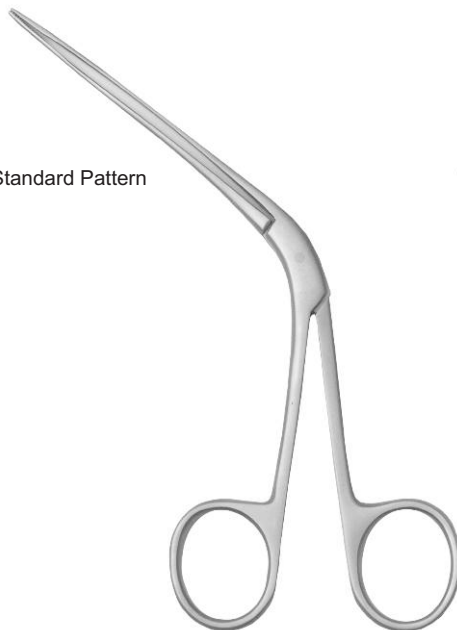

Tilley Aural Forcep
 17-4851-14 14cm/5 ½"
 17-4851-16 16cm/6 ¼"
 17-4851-18 18cm/7"



Buck
 17-4852-09
 9 cm/3½"



Quire
 17-4853-08
 8 cm/3¼"

OTOLOGY



Hartmann-Noyes
17-4854-09
8.5 cm/3 1/4"

1 : 2



Hartmann-Noyes
17-4855-09
8.5 cm/3 1/4"



Hartmann
17-4856-09 8.5 cm/3 1/4"
17-4856-14 14 cm/5 1/2"
17-4856-16 16 cm/6 1/4"

1 : 2



Hartmann
17-4857-09 8.5 cm/3 1/4"
17-4857-14 14.0 cm/5 1/2"



Hartmann
17-4858-20 8.5 cm/3 1/4" ○ 2.0 mm
17-4858-25 8.5 cm/3 1/4" ○ 2.5 mm
17-4858-30 8.5 cm/3 1/4" ○ 3.0 mm



Hartmann-Citelli
17-4859-02 ○ 2 mm 8.5 cm/3 1/4"
17-4859-03 ○ 3 mm 8.5 cm/3 1/4"



Strumpel
17-4860-09
8.5 cm/3 1/4"

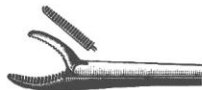

Hartamm-Weingartner
17-4861-09
8.5 cm/3 1/4"



Hartamm
17-4862-09
8.5 cm/3 1/4"















Hartamm-Wullstein
17-4863-06 8.5 cm/3 1/4" 08 x 6 mm
17-4863-08 8.5 cm/3 1/4" 1.8 x 8 mm



Hartamm-Wullstein
17-4864-01 ○ 1 mm 8.5 cm/3 1/4"
17-4864-02 ○ 2 mm 8.5 cm/3 1/4"

OTOLOGY



	Micro Forceps	Mini	Cup-Shaped Forceps
	1.6 x 7.0 mm  17-4865-01	0.7 x 3.5 mm  17-4866-08	0.9 x 1.1 mm  17-4867-11
	 17-4868-02 0.8 x 4.0 mm		
Smooth Jaw	 17-4869-03 0.8 x 6.0 mm		
Curved Left	 17-4870-04 0.8 x 6.0 mm		 17-4871-12 0.9 x 1.1 mm
Curved Right	 17-4872-05 0.8 x 4.0 mm		 17-4873-13 0.9 x 1.1 mm
Angled Up	 17-4874-06 0.8 x 4.0 mm		 17-4875-14 0.9 x 1.1 mm
Angled Down	 17-4876-07 0.8 x 4.0 mm		 17-4877-15 0.9 x 1.1 mm

OTOLOGY

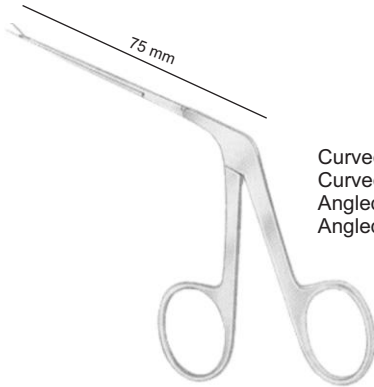

Curved Right 17-4878-01
 Curved Left 17-4878-02
 Angled Up 17-4878-03
 Angled Down 17-4878-04



Cup-Shaped Forceps

Micro Forceps 0.5 mm

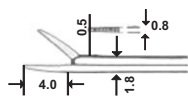

Straight 17-4879-01

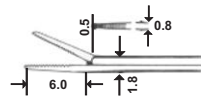

17-4879-02

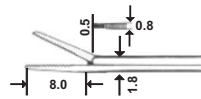

17-4879-03

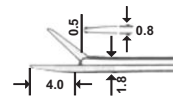

17-4879-04

Smooth Jaw 1.5 x 0.8 mm

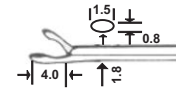

Straight 17-4883-01
 Curved Right 17-4883-02
 Curved Left 17-4883-03
 Angled Up 17-4883-04
 Angled Down 17-4883-05

0.3 mm

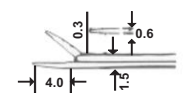

Straight

17-4880-01

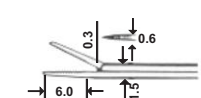

17-4881-02

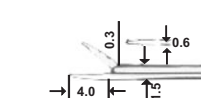

Smooth Jaw

17-4882-03

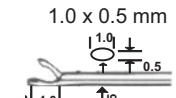

Straight

17-4883-06

Length of Shaft 8 cm

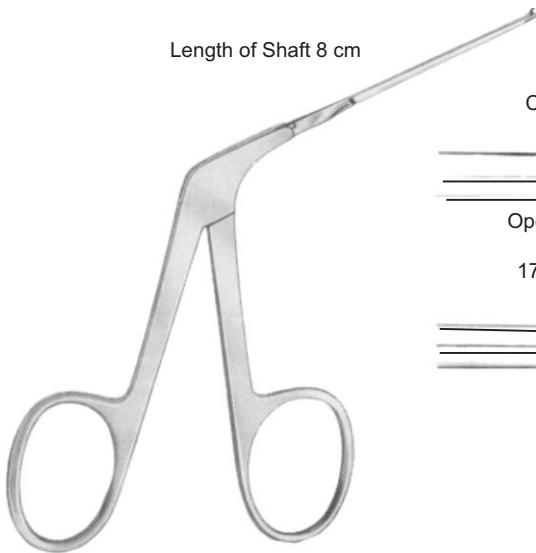

Crura Forceps



Open to Right
Fisch
 17-4885-01

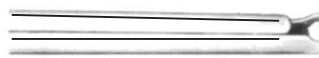

Open to Left
Fisch
 17-4885-02

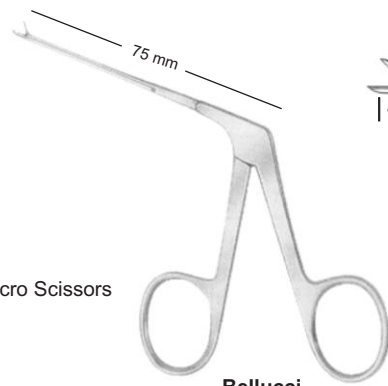

Micro Scissors

Bellucci
 0.8 mm

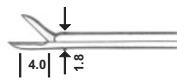

17-4884-01
 17-4884-02
 17-4884-03
 17-4884-04
 17-4884-05

Length of Shaft 8 cm



Wire Closure Forceps



Mc Gee
 17-4886-01



Mc Gee/Fisch
 17-4886-02

OTOLOGY



Henckel
crocodile, scoop blades
17-4887-02

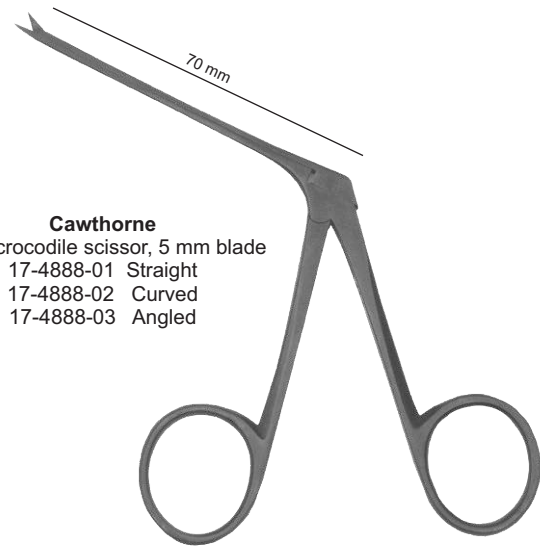

Cawthorne
micro crocodile scissor, 5 mm blade
17-4888-01 Straight
17-4888-02 Curved
17-4888-03 Angled

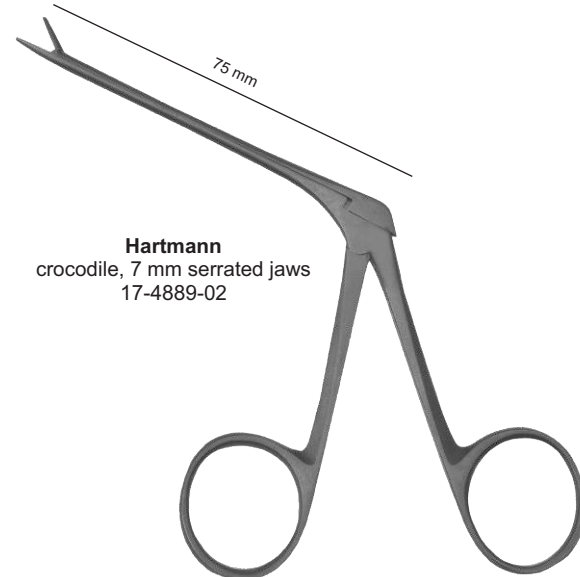

Hartmann
crocodile, 7 mm serrated jaws
17-4889-02

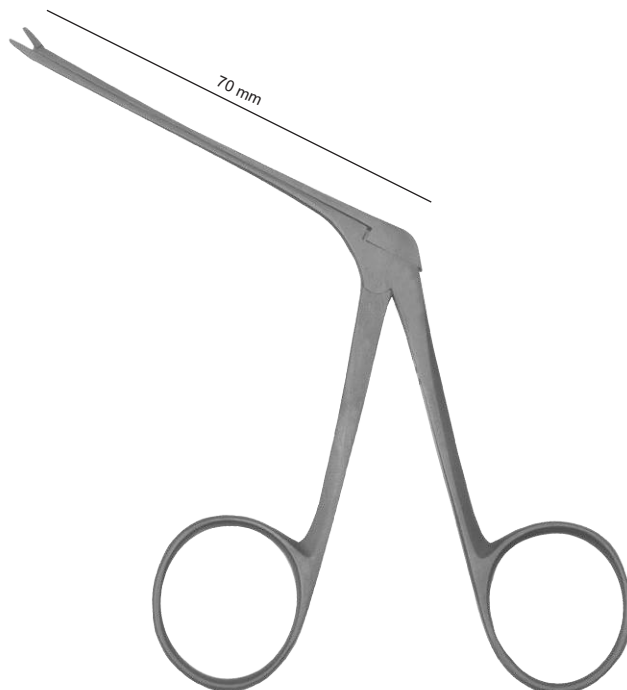

Hartmann
micro crocodile, 3 mm serrated jaws
17-4890-02

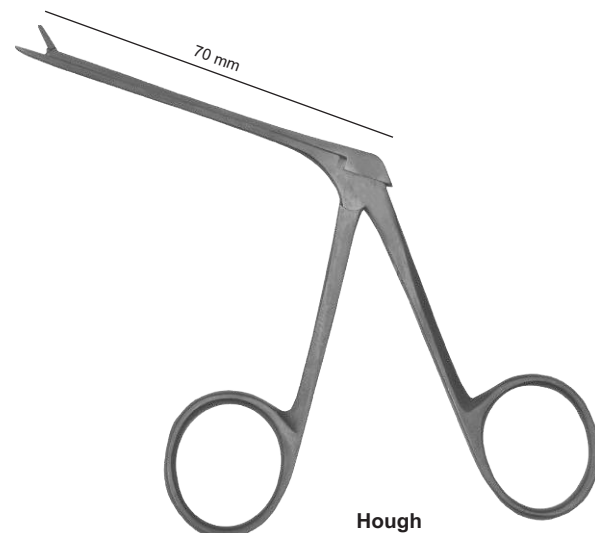

Hough
medium micro crocodile
5 mm serrated jaws
17-4891-01 Straight
17-4891-02 Angled

OTOLOGY

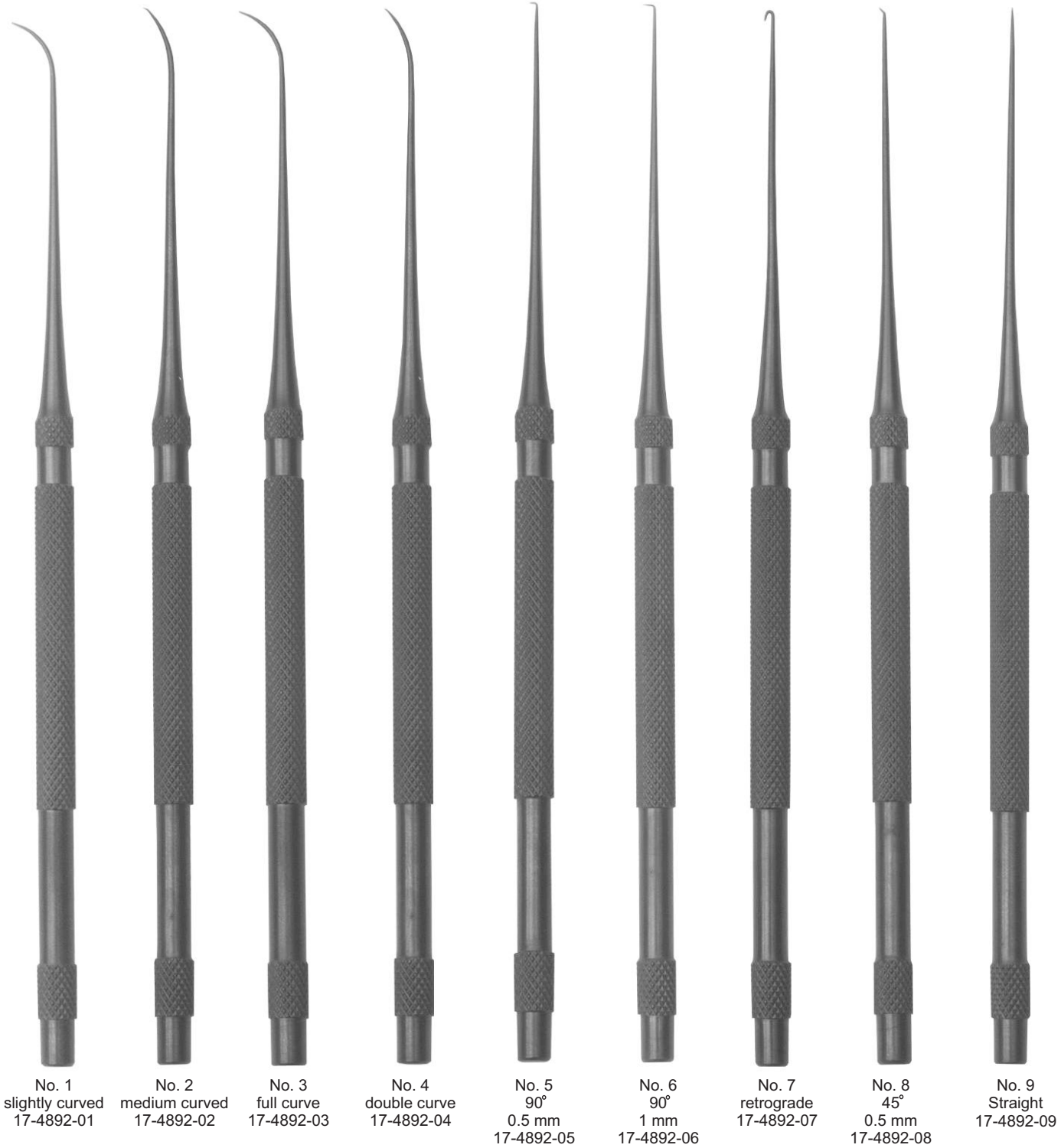

Cawthorne Stape Hook (Black Finish)
16.5cm / 6 1/2"
17-4892-10 (set of 9)

OTOLOGY

Messer

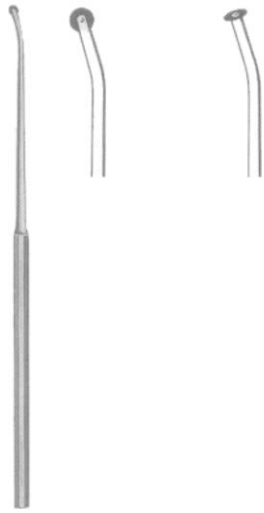

Schuknecht
17-4893-01

Schuknecht
17-4894-02

Schuknecht
17-4895-01

Knives



Wullstein
17-4896-01



Tabb
17-4897-01



Plester
17-4898-01



Plester
17-4899-02



17-4900-03



Rosen



17-4901-10
1.0 mm



17-4904-20
2.0 mm



17-4902-14
1.4 mm



17-4905-26
2.6 mm



17-4906-28
2.8 mm



17-4903-16
1.6 mm



17-4907-30
3.0 mm

OTOLOGY

Needles And Hooks



Barbara
17-4908-01



17-4908-02



17-4908-03



Rosen
17-4908-04



Barbara



25°
17-4909-03 0.3 mm
17-4909-06 0.6 mm
17-4909-10 1.0 mm



45°
17-4910-03 0.3 mm
17-4910-06 0.6 mm
17-4910-10 1.0 mm
17-4910-12 1.2 mm
17-4910-15 1.5 mm
17-4910-20 2.0 mm
17-4910-25 2.5 mm



90°
17-4911-03 0.3 mm
17-4911-06 0.6 mm
17-4911-10 1.0 mm
17-4911-12 1.2 mm
17-4911-15 1.5 mm
17-4911-20 2.0 mm
17-4911-25 2.5 mm



17-4912-05 0.5 mm
17-4912-10 1.0 mm

OTOLOGY

Needles And Hooks

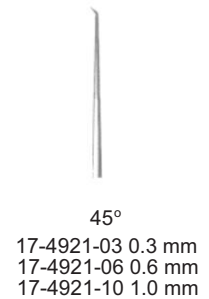
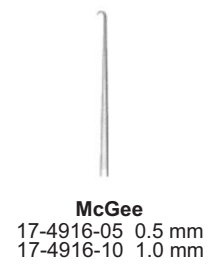
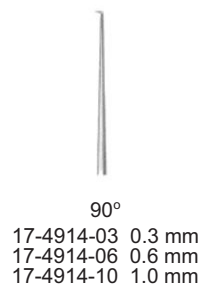
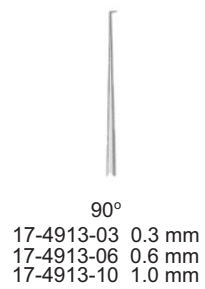

OTOLOGY

Dissectors, Measuring Road, Elevators, Curettes and Mobilizer



Fisch



17-4922-01



17-4922-02



17-4922-03



17-4922-04



Rosen

17-4923-15 1.5 mm
17-4923-25 2.5 mm



Rosen



17-4924-01



17-4924-02



17-4924-03



17-4924-04



17-4924-05



17-4924-06



House



17-4925-01
3.5 mm



17-4925-02
4.0 mm



17-4925-03
4.5 mm



17-4925-04
5.0 mm

OTOLOGY

**Buckingham**

17-4926-01



17-4926-02



17-4926-03

St. Bart Blunt Hook
 17-4927-18
 18 cm / 7"

House
 17-4928-10 1.0/1.2 mm
 17-4928-15 1.5/1.8 mm

House
 17-4929-10 1.0/1.2 mm
 17-4929-15 1.5/1.8 mm

Shea
 17-4930-15 1.5 mm

Negus Aspiration 17-4931-18
 21 cm / 8 1/4"
Jobson Horne Probe
 one side serrated
 one side ring
 17-4932-17
 17.5 cm / 7"

OTOLOGY



Zollner

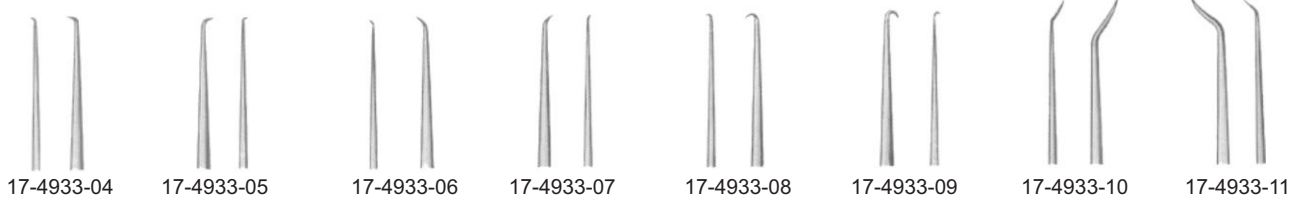

OTOLOGY



Citelli
 Width of Bite 17-4934-20 2.0 mm
 17-4934-30 3.0 mm



Citelli-Beyer
 Width of Bite 17-4935-15 1.5 mm
 17-4935-20 2.0 mm



Brunings
 Width of Bite 17-4936-40 4.0 mm
 17-4936-60 6.0 mm

-  17-4937-30 3.0 mm
-  17-4937-40 4.0 mm
-  17-4937-50 5.0 mm
-  17-4937-60 6.0 mm

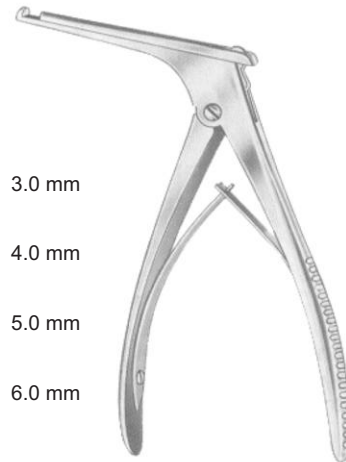

Kerrison
 20 cm/8"

EN Rhinology

DE Rhinologie

ES Rinología

Page 438 to 462



RHINOLOGY



Fraenkel
18-5001-01 Fig. 1
18-5001-02 Fig. 2
18-5001-03 Fig. 3



18-5002-01
18-5002-02
18-5002-03
13 cm/5"



Fig. 1
18-5003-01
18-5003-01



Fig. 2
18-5004-02
18-5004-02



Fig. 3
18-5005-03
18-5005-03



18-5006-01
18-5006-02
18-5006-03
13 cm/5"



Hartmann
15 cm/6"

18-5007-01

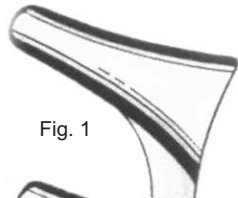

Fig. 1

18-5008-01

18-5007-02

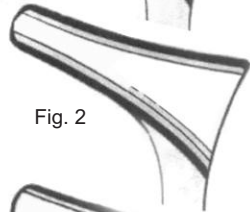

Fig. 2

18-5008-02

18-5007-03

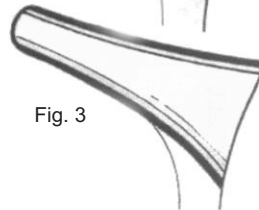

Fig. 3

18-5008-03



Hartmann
15 cm/6"

RHINOLOGY



18-5009-01

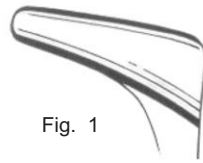

Fig. 1

18-5009-02

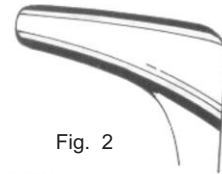

Fig. 2

18-5009-03

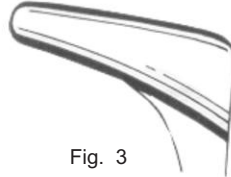

Fig. 3

Hartmann-Halle
15 cm/6"



18-5010-01

18-5010-02

18-5010-03

Hartmann-Halle
15 cm/6"



18-5011-01

18-5011-02

Tieck
13.5 cm/5 1/4"



18-5012-01

18-5012-02



Tieck
13.5 cm/5 1/4"



Beckmann
15 cm/6"

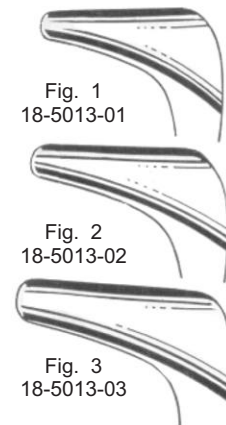

Fig. 1
18-5013-01

Fig. 2
18-5013-02

Fig. 3
18-5013-03

RHINOLOGY



Mod.Wien

18-5014-01



Fig.1

18-5014-02

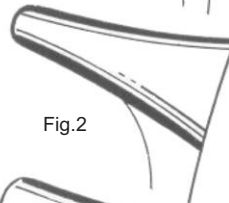

Fig.2

18-5014-03

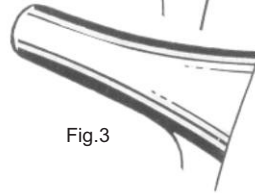

Fig.3

18-5015-01



Wien

18-5015-02

18-5015-03



Killian



Fig.1
18-5016-01
35 mm

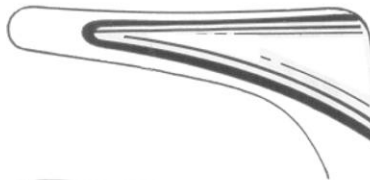

Fig.2
18-5016-02
50 mm



Fig.3
18-5016-03
75 mm



Fig.4
18-5016-04
90 mm

RHINOLOGY



Cottle
 18-5017-01
 18-5017-02
 18-5017-03
 18-5017-04
 15 cm/6"

Cottle
 18-5018-01
 18-5018-02
 18-5018-03
 18-5018-04
 15 cm/6"

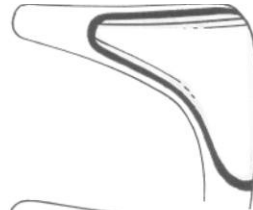

Fig 1
 18-5017-01
 18-5018-01
 35 mm



Fig 2
 18-5017-02
 18-5018-02
 50 mm



Fig 3
 18-5017-03
 18-5018-03
 75 mm

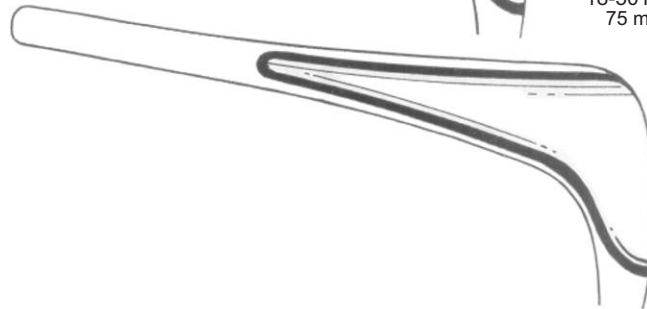
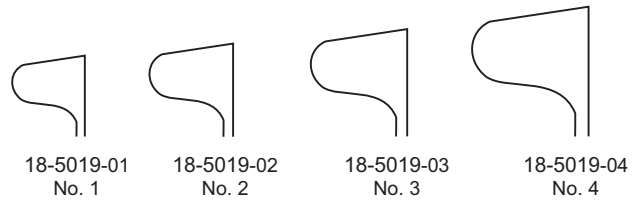

Fig 4
 18-5017-04
 18-5018-04
 90 mm



Thudicum Nasal Speculum
 Length 7 cm

- 18-5019-30 No. 1- 3 (set of 3)
- 18-5019-40 No. 1- 4 (set of 4)
- 18-5019-70 No. 1- 7 (set of 7)



18-5019-01 No. 1 18-5019-02 No. 2 18-5019-03 No. 3 18-5019-04 No. 4

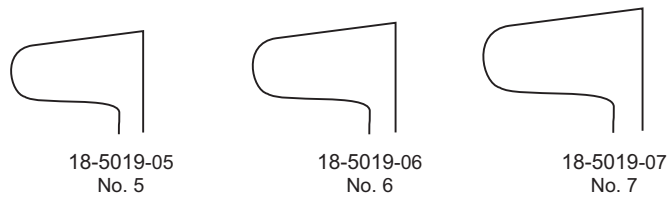

18-5019-05 No. 5 18-5019-06 No. 6 18-5019-07 No. 7

RHINOLOGY

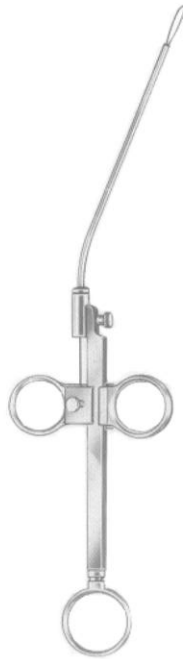

Krause
 18-5020-26
 26 cm/10¼"

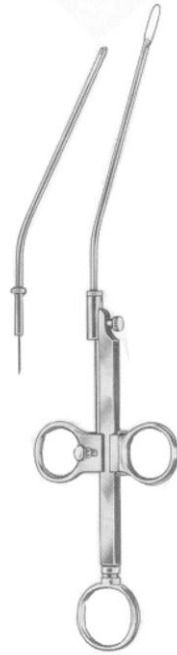

Krause-Voss
 18-5021-26
 26 cm/10¼"



Lange-Wilde
 18-5022-24
 24 cm/9½"



Package Of 1 Dozen Each
 18-5023-10
 0.3 mm



Cm	In
15.0	6
18.0	7
20.0	8



Cm	In	Troeltsch (Wilde)	Gruenwald (Jansen)
15.0	6	18-5024-15	18-5025-16
18.0	7	18-5024-18	18-5025-18
20.0	8		18-5025-20



Westmacott (West)
 18-5026-20
 20 cm/8"

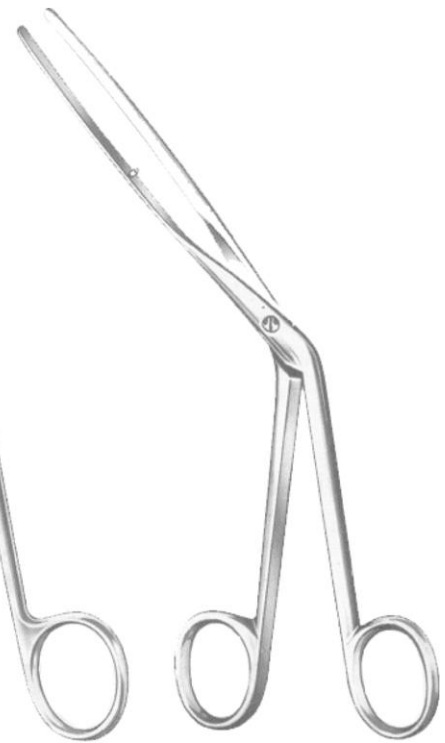

Lubet-Barbon
 18-5027-20
 20 cm/8"

RHINOLOGY



Hartmann
 18-5028-16
 16 cm/6 1/4"

Hartmann
 18-5029-20
 20 cm/8"

Heymann
 18-5030-18
 18 cm/7"

Craig
 18-5031-18
 18 cm/7"

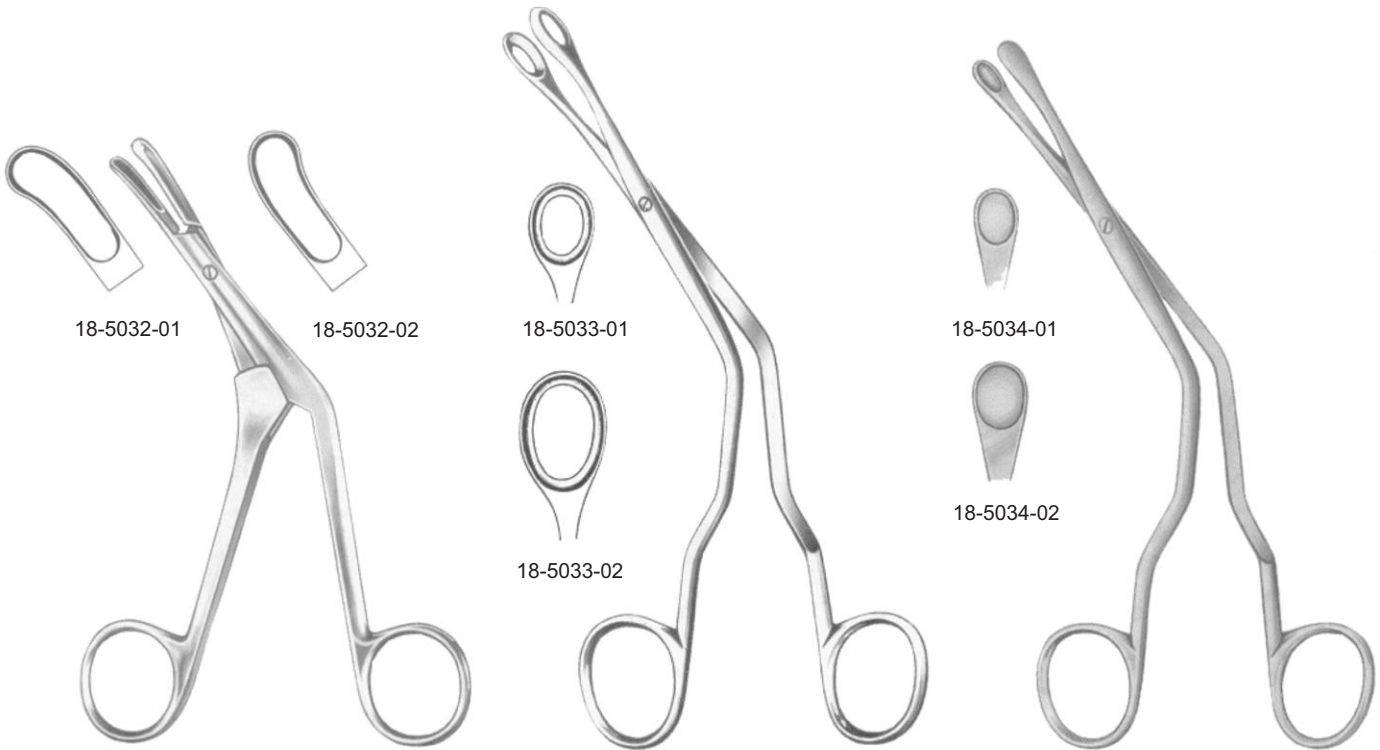

Craig Domnick
 18 cm/7"

Luc
 20 cm/8"

Luc
 20 cm/8"

RHINOLOGY



Bruenings
19 cm/7½"

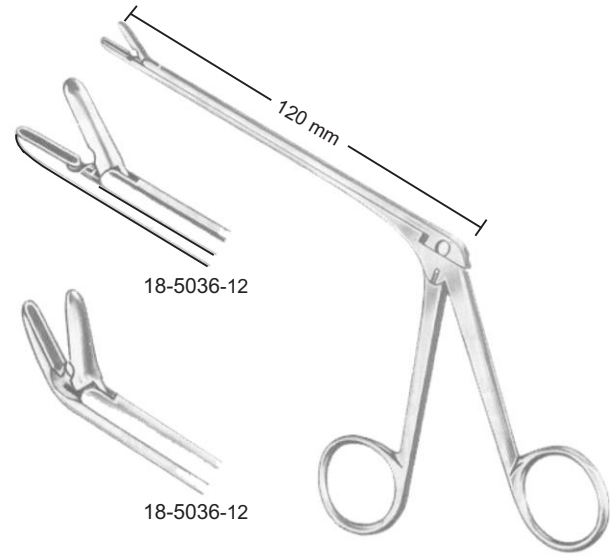

Takahashi
19 cm/7½"



Watson-Williams
19 cm/7½"

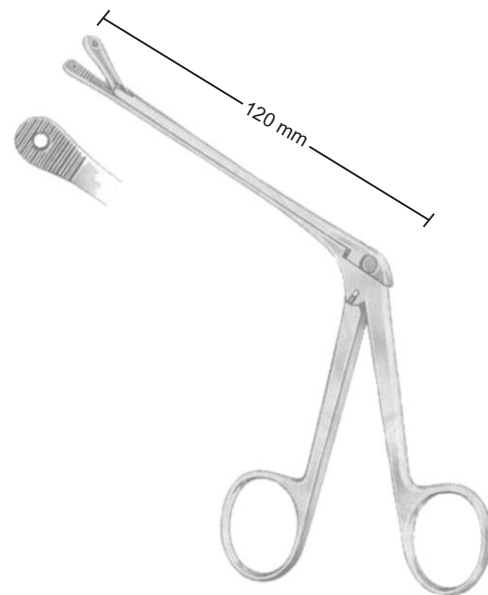

Ferris-Smith
18-5038-12
19 cm/7½"

RHINOLOGY

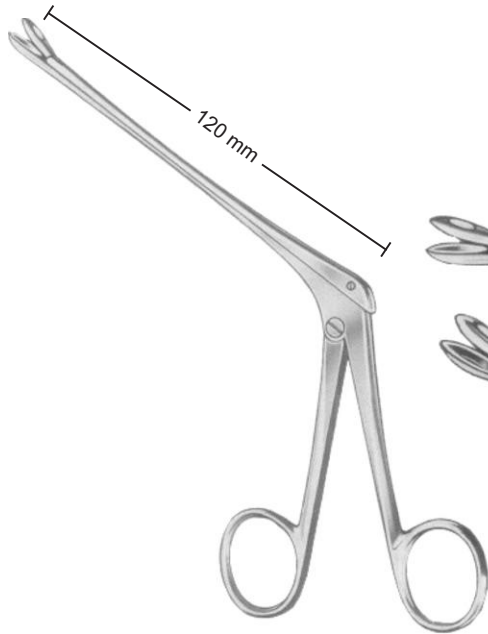

Weil-Blakesley

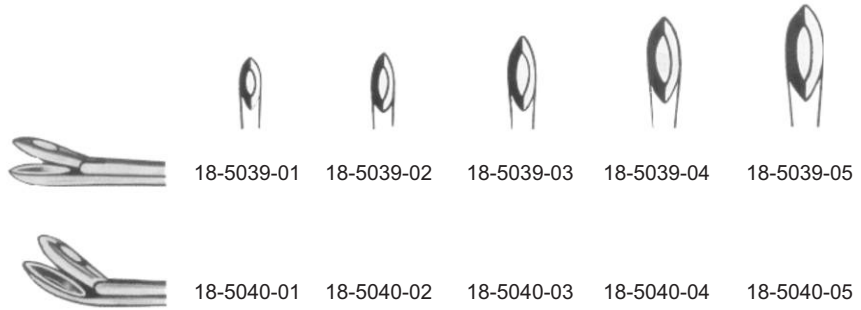

Struycken

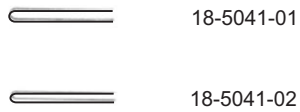

Hajek

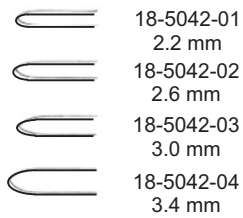

Myles

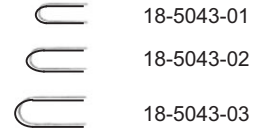

Grunwald



Hartmann

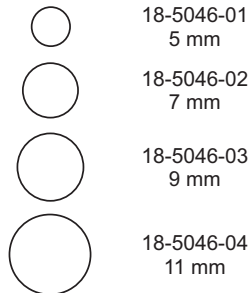

Schmeden

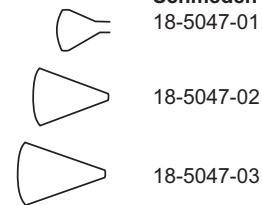

Grunwald
18-5045-01



RHINOLOGY

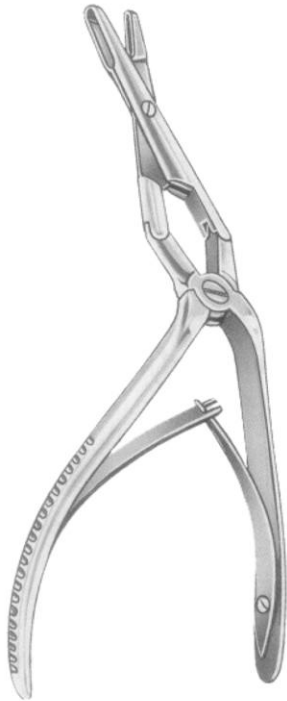

Middleton-Jansen
18-5048-19
19 cm/7½"

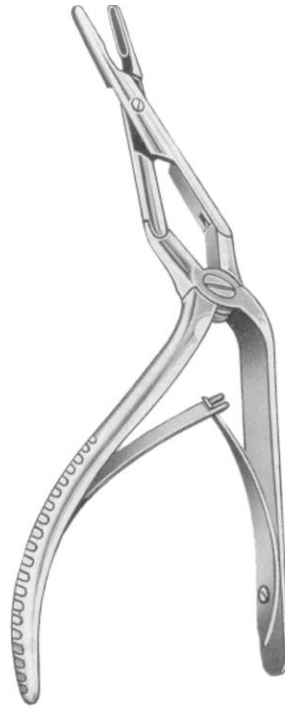

Middleton-Jansen
18-5049-19
19 cm/7½"



Kazanjian
18-5050-18
18 cm/7"



Caplan
18-5051-20
20 cm/8"



18-5052-01
5x4 mm



18-5052-02
5x4 mm



18-5052-03
5x3.5 mm



18-5052-04
5x3.5 mm

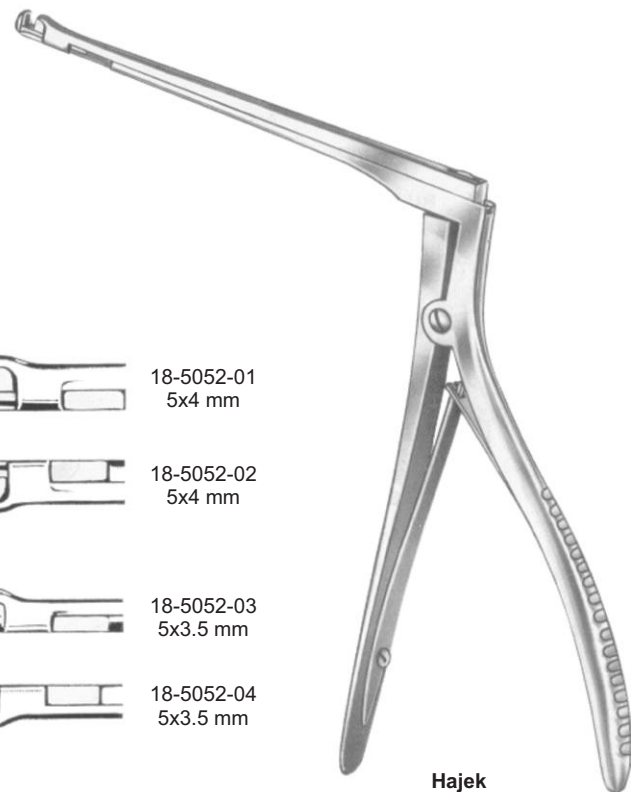

**Hajek
(Hajek-Kofler)
Shaft**
14 cm/5½"

RHINOLOGY



Ferris-Smith-Kerrison



Ferris-Smith-Kerrison

		Width of Bite		Length of Shaft		Width of Bite		Length of Shaft	
		15 cm/6"	20 cm/8"	15 cm/6"	20 cm/8"	18 cm/7"	15 cm/6"	20 cm/8"	18 cm/7"
Cutting Upward		18-5053-03	3 mm	18-5056-03	18-5059-03	1 mm	18-5061-03	18-5064-03	18-5067-01
		18-5053-05	5 mm	18-5056-05	18-5059-05	2 mm		18-5064-03	18-5067-02
						3 mm		18-5064-03	18-5067-03
						4 mm		18-5064-05	18-5067-04
						5 mm		18-5064-05	18-5067-05
Cutting Upward 40°		18-5054-03	3 mm	18-5057-03		1 mm	18-5062-03	18-5065-03	18-5068-01
		18-5054-05	5 mm	18-5057-05		2 mm		18-5065-03	18-5068-02
						3 mm		18-5065-05	18-5068-03
						4 mm		18-5065-05	18-5068-04
						5 mm		18-5065-05	18-5068-05
Cutting Downward		18-5055-03	3 mm	18-5058-03	18-5060-03	1 mm	18-5063-03	18-5066-03	18-5069-01
		18-5055-05	5 mm	18-5058-05	18-5060-05	2 mm		18-5066-03	18-5069-02
						3 mm		18-5066-05	18-5069-03
						4 mm		18-5066-05	18-5069-04
						5 mm		18-5066-05	18-5069-05



360° Turnable

Hajek-Kofler
 18-5070-16
 16 cm/6½"

- 18-5071-03
3 mm
- 18-5071-04
4 mm
- 18-5071-05
5 mm
- 18-5071-06
6 mm



Kerrison
 20 cm/8"

RHINOLOGY



Jurasz
22 cm/8¾"



18-5072-01

18-5072-02

18-5072-03

Rhinoplastic and Nasal Knives

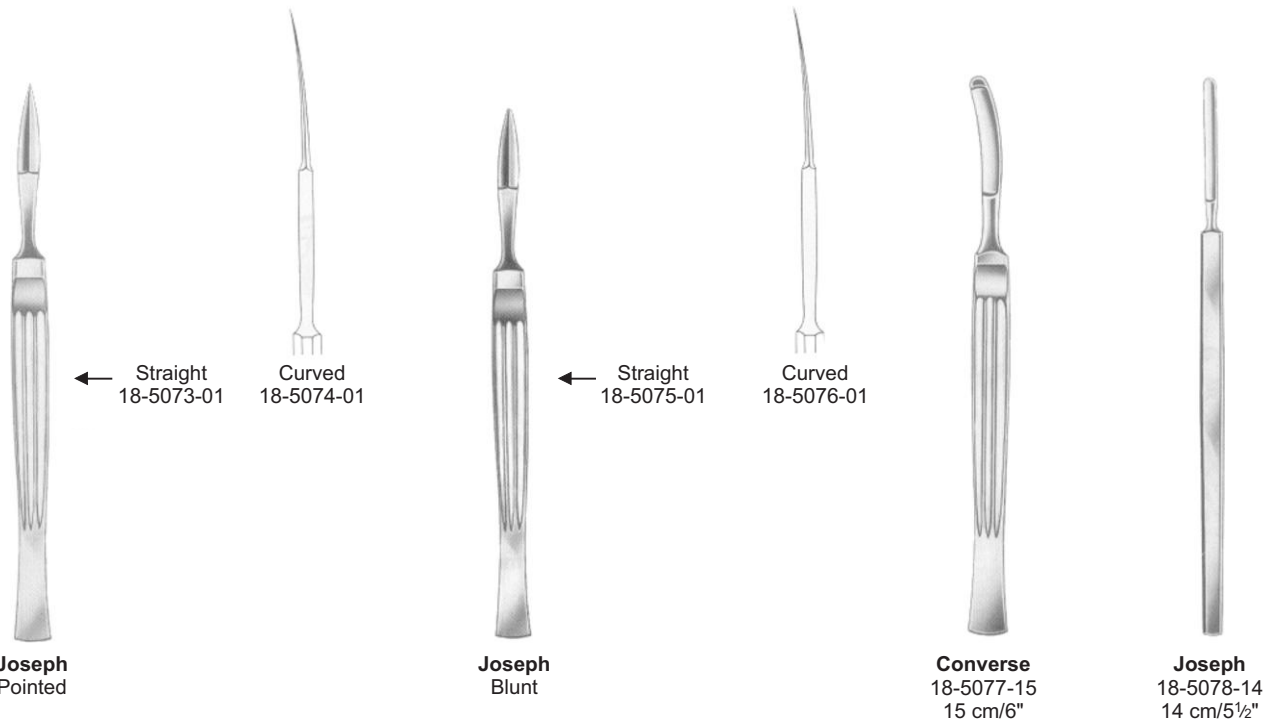

← Straight
18-5073-01

Curved
18-5074-01

← Straight
18-5075-01

Curved
18-5076-01

Joseph
Pointed

Joseph
Blunt

Converse
18-5077-15
15 cm/6"

Joseph
18-5078-14
14 cm/5½"

RHINOLOGY



Cottle
18-5079-15
15 cm/6"



Cottle
18-5080-14
14 cm/5½"



Freer
18-5081-16
16 cm/6¼"



Joseph
18-5082-16
16.5 cm/6½"



Maltz
18-5083-16
16.5 cm/6½"



Freer
18-5084-19
19 cm/7½"

Septum Knives



Ballenger
20cm/8"



18-5085-03 3 mm 18-5086-03
18-5085-04 4 mm 18-5086-04
18-5085-05 5 mm 18-5086-05



Ballenger
20cm/8"



Bruenings
18-5087-16

RHINOLOGY



18-5088-04 4 mm
18-5088-05 5 mm

Mc Kenty
15 cm/6"



Halle
18-5089-16
16.5 cm/6½"



Joseph
18-5090-16
16.5 cm/6½"



Cottle
18-5091-19
19.5 cm/7½"



Blunt

Freer
18-5092-19
19 cm/7½"



Sharp

Freer
18-5093-19
19 cm/7½"



Freer
18-5094-18
18 cm/7"

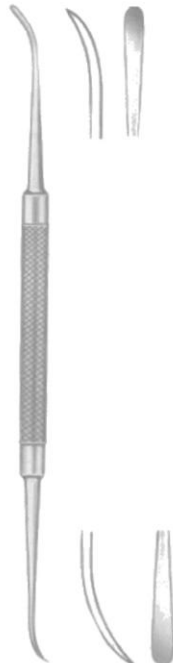

Freer-Yasargil
18-5095-18
18.5 cm/7¼"



Howarth
18-5096-21
21.5 cm/8½"



Mc Kenty
18-5097-22
22 cm/8¾"

RHINOLOGY

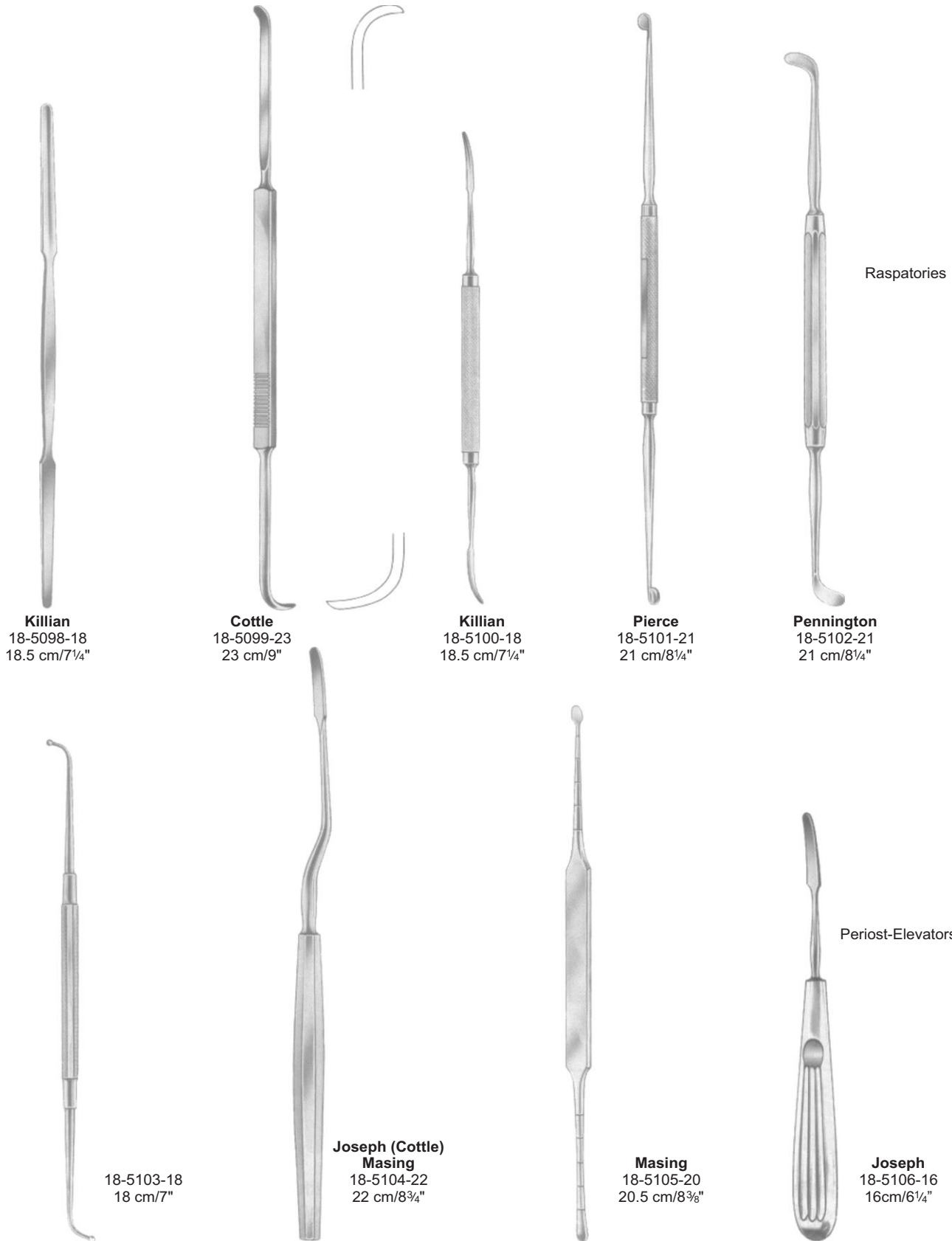

Killian
 18-5098-18
 18.5 cm/7¼"

Cottle
 18-5099-23
 23 cm/9"

Killian
 18-5100-18
 18.5 cm/7¼"

Pierce
 18-5101-21
 21 cm/8¼"

Pennington
 18-5102-21
 21 cm/8¼"

18-5103-18
 18 cm/7"

**Joseph (Cottle)
 Masing**
 18-5104-22
 22 cm/8¾"

Masing
 18-5105-20
 20.5 cm/8⅜"

Joseph
 18-5106-16
 16cm/6¼"

Raspatories

Periost-Elevators

RHINOLOGY



Freer
18-5107-16
16 cm/6¼"



Freer
18-5108-16
16 cm/6¼"



Freer
18-5109-15
15 cm/6"



Ballenger
18-5110-04 4 mm
18-5110-06 6 mm
18-5110-08 8 mm
16 cm/6¼"



Killian
18-5111-16
16 cm/6¼"



Killian-Claus
18-5112-16
16 cm/6¼"

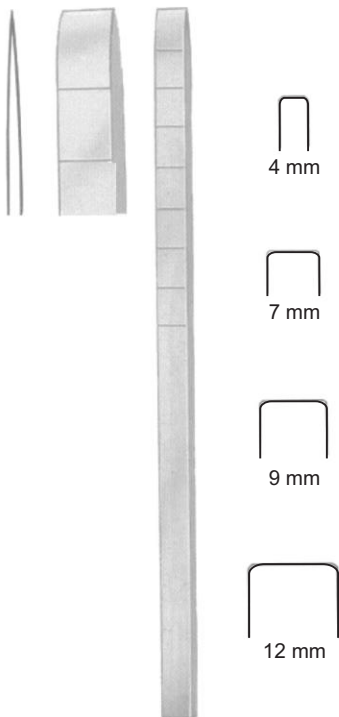

Cottle
18-5113-04 4 mm
18-5113-07 7 mm
18-5113-09 9 mm
18-5113-12 12 mm
18 cm/7"



Cottle
18-5114-04 4 mm
18-5114-07 7 mm
18-5114-09 9 mm
18-5114-12 12 mm
18 cm/7"



Cottle
18-5115-18
18 cm/7"



Cottle
18-5116-18
18 cm/7"

RHINOLOGY



18-5117-08
 16 cm/6¼"
 8 mm



Cottle
 18-5118-04 4 mm
 18-5118-07 7 mm
 18-5118-09 9 mm
 18-5118-12 12 mm
 18 cm/7"



Cottle
 Curved
 18-5119-06
 18 cm/7"
 6 mm



Fomon
 18-5120-05 5mm
 18-5120-08 8mm
 17 cm/6¾"



Walter
 18-5121-03 3 mm
 18-5121-04 4 mm
 18 cm/7"



18-5122-01



**(Silver)
 Masing**
 18-5123-02
 17.5 cm/7⅞"



18-5124-03



Cinelli
 18-5125-10 10 mm
 18-5125-12 12 mm
 18-5125-14 14 mm
 18-5125-16 16 mm
 16 cm/6¼"

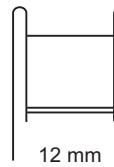
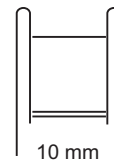

Masing
 18-5126-17
 17.5 cm/6⅞"

RHINOLOGY



West
18-5127-16
16 cm/6¼"



West
18-5128-16
16 cm/6¼"



18-5129-01

18-5129-02

Joseph
17 cm/6¾"



Joseph
18-5130-01
17 cm/6¾"



Joseph
18-5131-02
17 cm/6¾"



Joseph
18-5132-03
17 cm/6¾"

RHINOLOGY

TC



Fig.1



Fig.3



Fig.5



Fig.7



Fig.9



Fig.2



Fig.4



Fig.6



Fig.8



Fig.10

Famon

- Fig. 1/ 2 18-5133-12
 - Fig. 3/ 4 18-5133-34
 - Fig. 5/ 6 18-5133-56
 - Fig. 7/ 8 18-5133-78
 - Fig. 9/10 18-5133-90
- 21 cm/8 1/4"

TC



Parkes

- Fig. 1 18-5134-01
 - Fig. 2 18-5134-02
 - Fig. 3 18-5134-03
 - Fig. 4 18-5134-04
 - Fig. 5 18-5134-05
 - Fig. 6 18-5134-06
 - Fig. 7 18-5134-07
 - Fig. 8 18-5134-08
 - Fig. 9 18-5134-09
 - Fig.10 18-5134-10
- 20.5 cm/8 1/8"

Maltz

- Fig. 1 18-5135-01
 - Fig. 2 18-5135-02
 - Fig. 3 18-5135-03
 - Fig. 4 18-5135-04
 - Fig. 5 18-5135-05
 - Fig. 6 18-5135-06
 - Fig. 7 18-5135-07
 - Fig. 8 18-5135-08
 - Fig. 9 18-5135-09
 - Fig.10 18-5135-10
- 17 cm/6 3/4"

RHINOLOGY



Maltz
18-5141-18
18 cm/7"



Joseph
16 cm/6¼"

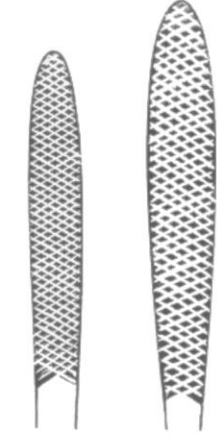

18-5142-01 18-5142-02



Lewis
18 cm/7"



Fine
18-5143-01



Coarse
18-5143-02



Cottle
18-5144-21
21 cm/8¼"



Aufricht
21 cm/8¼"

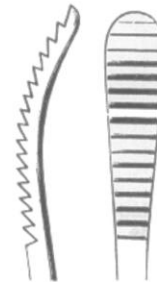

18-5145-01

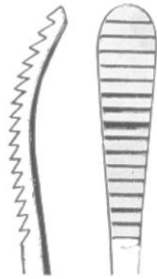

18-5145-02

RHINOLOGY



Maltz
17 cm/6¾"

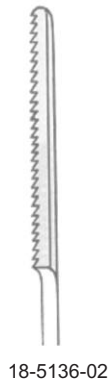

Miller
16 cm/6¼"

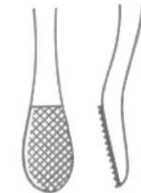
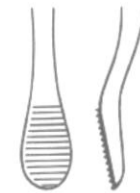

19 cm/7½"



Aufricht
18-5139-17
17.5 cm/6⅞"

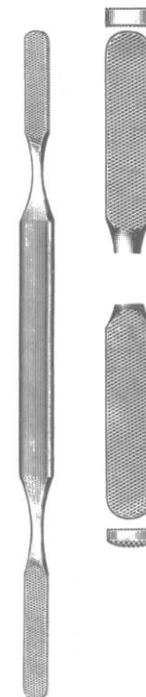

Fomon
18-5140-21
21 cm/8¼"



RHINOLOGY

Hooks



Fomon
18-5146-14
14.5 cm/5 3/4"



Cottle
18-5147-14
14.5 cm/5 3/4"



Cottle
18-5148-14
14.5 cm/5 3/4"



Cottle
18-5149-14
14.5 cm/5 3/4"



Cottle
18-5150-16
15 cm/6"



Kilner
18-5151-08
8 cm/3 1/8"
10 mm

Columella Forceps



Converse
18-5152-12
12 cm/4 3/4"

Aufricht
18-5153-16
16 cm/6 1/4"



Cottle
18-5154-10
10 cm/4"

Tissue Lifter



18-5155-14
14 cm/5 1/2"

Tissue Picks



18-5156-11
11 cm/4 3/8"



1.0 mm 18-5157-10
1.8 mm 18-515718

RHINOLOGY



Walsham
23 cm/9"



18-5158-01



18-5158-02



18-5158-03



Cottle-Walsham
18-5159-22
22 cm/8¾"



Asch
18-5160-23
23 cm/9"



Kressner
18-5161-20
20 cm/8"



Rubin
18-5162-20
20 cm/8"

RHINOLOGY



Faulkner
18-5163-21
21 cm/8¼"



Sewall
18-5164-20
20 cm/8"
6 mm



Coakley
17 cm/6¾"



18-5165-01



18-5165-02



18-5165-03



18-5165-04



18-5165-05



18-5165-06

Ringmesser

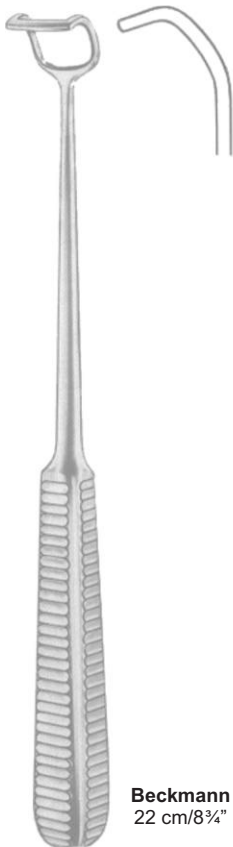

Beckmann
22 cm/8¾"

18-5166-01



18-5167-01

18-5166-02



18-5167-02

18-5166-03



18-5167-03

18-5166-04



18-5167-04

18-5166-05



18-5167-05

18-5166-06



18-5167-06

Adenoid Currettes



Negus
20 cm/8"

RHINOLOGY

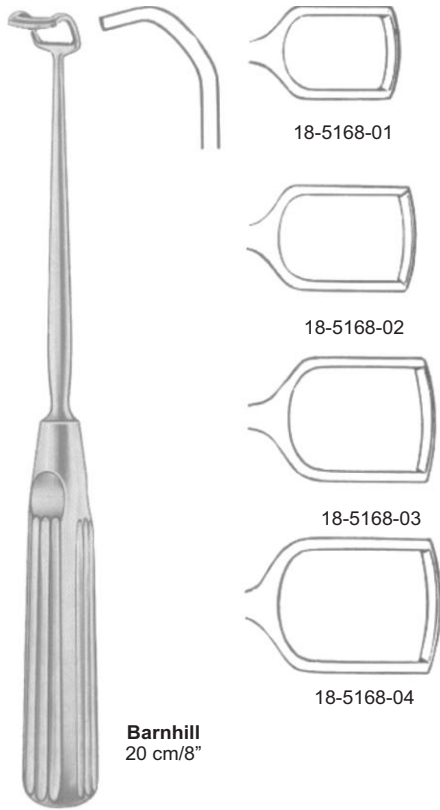

Barnhill
20 cm/8"

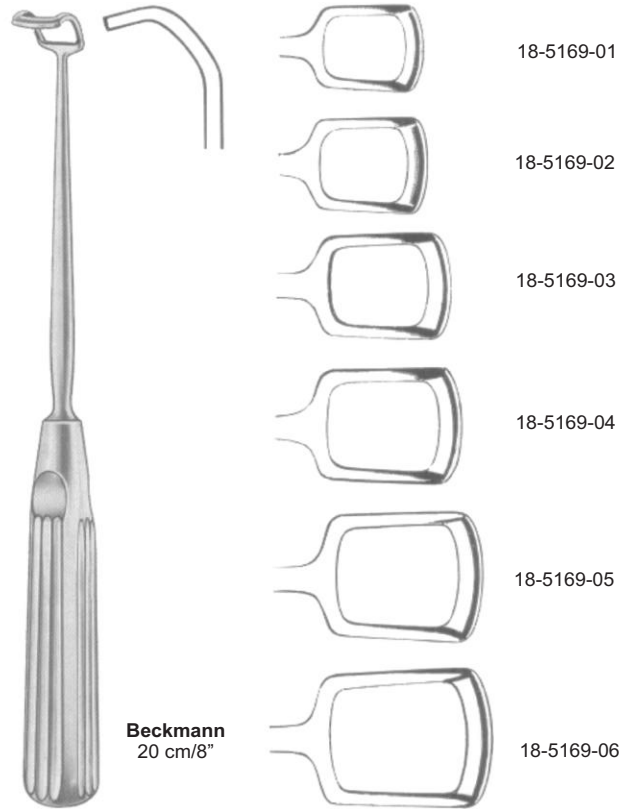

Beckmann
20 cm/8"

- 18-5170-10 10mm
- 18-5170-12 12mm
- 18-5170-14 14mm
- 18-5170-16 16mm
- 18-5170-18 18mm

- 18-5170-10A 10mm
- 18-5170-12A 12mm
- 18-5170-14A 14mm
- 18-5170-16A 16mm
- 18-5170-18A 18mm

St. Clair-Thompson
with graded
21.5cm/8 1/2"

St. Clair-Thompson
without graded
21.5cm/8 1/2"



La Force
23 cm/9"

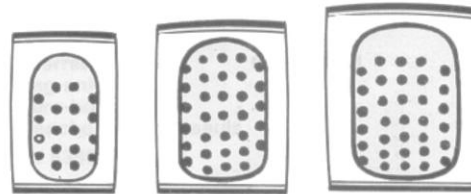

- 18-5171-01
- 18-5171-02
- 18-5171-03

Spare blades Only

- 18-5171-11
- 18-5171-12
- 18-5171-13

RHINOLOGY



Bruenings- Brunk
 18-5172-19
 91 cm/7½"

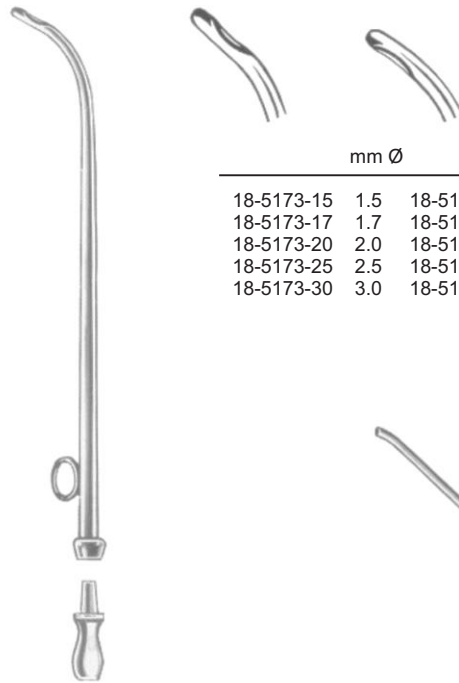

Siebenmann

mm Ø		
18-5173-15	1.5	18-5174-15
18-5173-17	1.7	18-5174-17
18-5173-20	2.0	18-5174-20
18-5173-25	2.5	18-5174-25
18-5173-30	3.0	18-5174-30

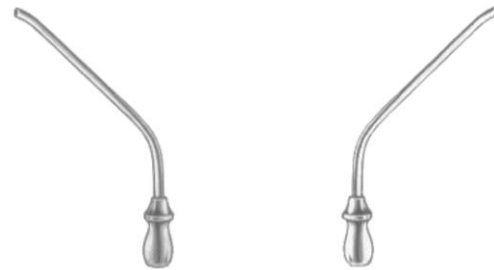

Hartmann

Fig. 1	mm Ø	Fig. 2
18-5175-20		18-5176-20
18-5175-25		18-5176-25
18-5175-30		18-5176-30



Eicken - Killian
 18-5177-03
 3 mm Ø



Killian
 18-5178-15
 1.5 mm Ø



Ritter - Halle
 2.5 mm 18-5179-25
 3.0 mm 18-5179-30
 4.0 mm 18-5179-40

- EN** Oral Instruments
- DE** Mund instrumente
- ES** Cirugía oral

Page 463 to 467



ORAL INSTRUMENTS

Gag Only
19-5251-10

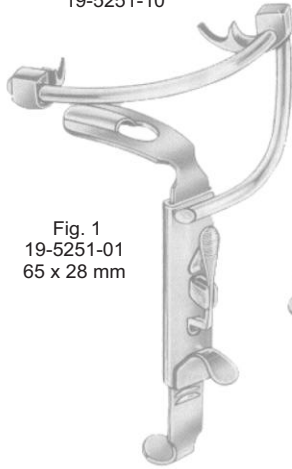

Fig. 1
19-5251-01
65 x 28 mm

Kilner-Doughty
Complete
19-5251-00



Fig. 2
19-5251-02
75 x 32 mm

Fig. 3
19-5251-03
80 x 37 mm

Gag Only
19-5252-10

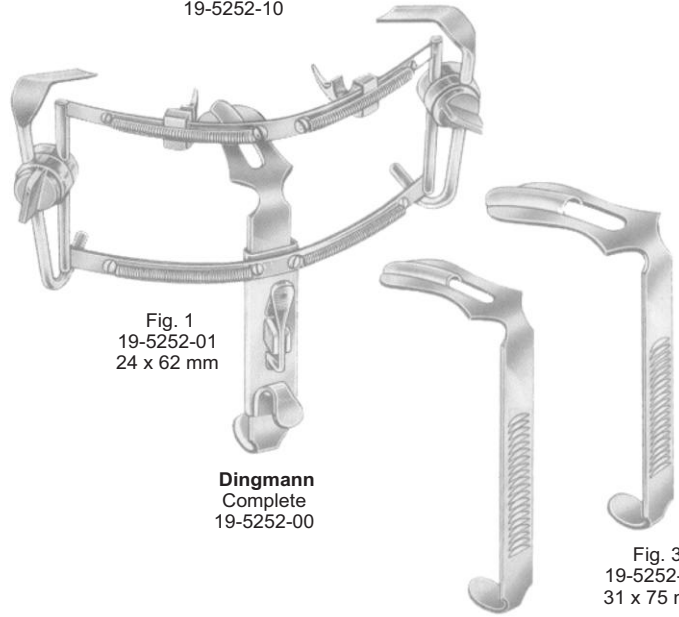

Fig. 1
19-5252-01
24 x 62 mm

Dingmann
Complete
19-5252-00

Fig. 2
19-5252-02
28 x 65 mm

Fig. 3
19-5252-03
31 x 75 mm



Gag Only
19-5253-10

Davis-Boyle
Complete
19-5253-00

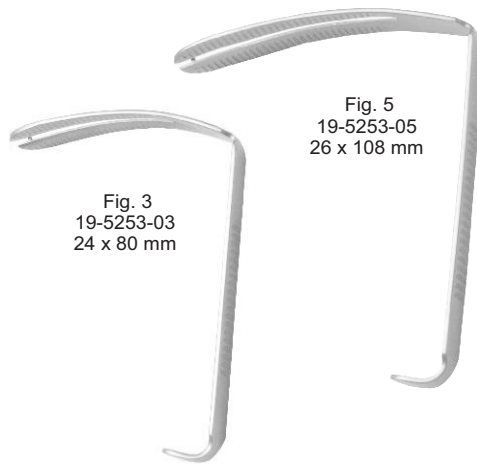

Fig. 3
19-5253-03
24 x 80 mm

Fig. 5
19-5253-05
26 x 108 mm



Fig. 1
19-5253-01
21 x 26 mm



Fig. 2
19-5253-02
23 x 65 mm

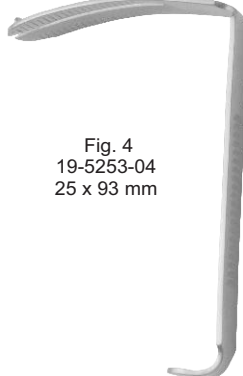

Fig. 4
19-5253-04
25 x 93 mm



Gag Only
19-5254-10

Mc Ivor
Complete
19-5254-00

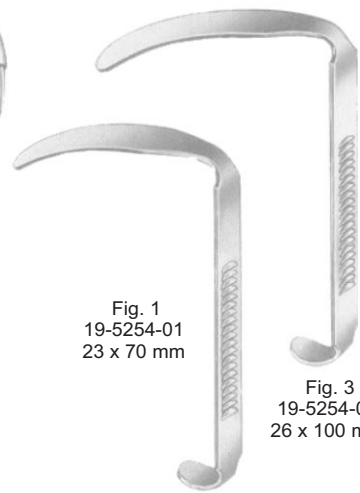

Fig. 1
19-5254-01
23 x 70 mm

Fig. 2
19-5254-02
25 x 86 mm

Fig. 3
19-5254-03
26 x 100 mm

ORAL INSTRUMENTS



Fig.		mm
2	19-5255-02	23 x 65
3	19-5255-03	24 x 80
4	19-5255-04	25 x 93
5	19-5255-05	26 x 108

Modell Wurzburg

Fig.		mm
1	19-5256-01	28 x 66
2	19-5256-02	32 x 75
3	19-5256-03	34 x 83
4	19-5256-04	37 x 93
5	19-5256-05	38 x 100



Chest Support for
Mouth gag
19-5257-00



Baby-Molt
19-5258-10
10 cm/4"

Molt
19-5259-11 11 cm/4 ¼"
19-5259-14 14 cm/5 ½"

Roser-Konig
19-5260-16 16 cm/6 ¼"
19-5260-19 19 cm/7 ½"

Denhart
19-5261-12
12 cm/4 ¾"

Mouth Gags

ORAL INSTRUMENTS



Heister
19-5262-13
13 cm/5"

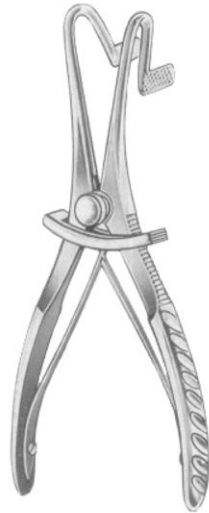

Fergusson-Ackland
19-5263-18 18 cm/7"
19-5263-20 20 cm/8"

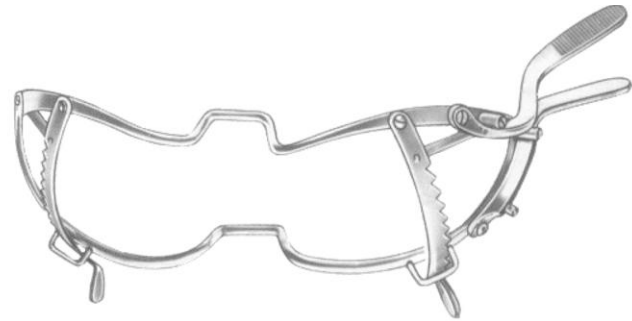

Whitehead
19-5264-11 11 cm/4 ¼"
19-5264-13 13 cm/5"
19-5264-15 15 cm/6"

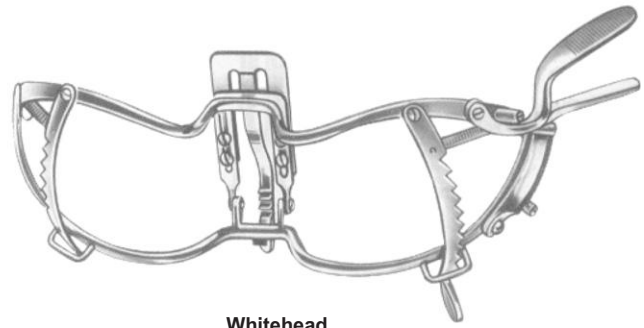

Whitehead
19-5265-13
13 cm/5"

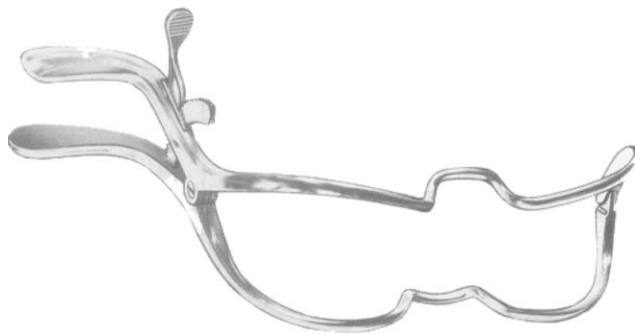

Jennings
19-5266-09 09 cm/3 ½"
19-5266-11 11 cm/4 ¼"
19-5266-13 13 cm/5"
19-5266-15 15 cm/6"



Sternberg
19-5267-12 12 cm/4 ¾"
19-5267-14 14 cm/5 ½"
19-5267-16 16 cm/6 ¼"



19-5268-19
19 cm/7 ½"



Moritz-Schmidt
19-5269-19
19 cm/7 ½"

ORAL INSTRUMENTS



Lack
 19-5270-15
 Child 12 mm
 Adolescent 19 mm
 Adult 22mm



Hartmann
 19-5271-15
 15 cm/6"



Tobold
 19-5272-14
 14.5 cm/5 ¾"



Fraenkel
 19-5273-19
 19 cm/7 ½"



Frenzel
 19-5274-16
 16.5 cm/6 ½"



19-5275-13
 13 cm/5"



19-5276-14
 14.5 cm/5 ¾"



19-5277-14
 14.5 cm/5 ¾"



Kroenig
 19-5278-15
 15 cm/6"



Mayo
 19-5279-17
 17 cm/6 ¾"

ORAL INSTRUMENTS



Draffin Bipod

4 rings

19-5280-38 38.5cm/15"

19-5280-48 48cm/19"



Bruenings
19-5281-19
19 cm/7½"



Bruenings
19-5282-19
19 cm/7½"



Wieder

19-5283-01

19-5283-02

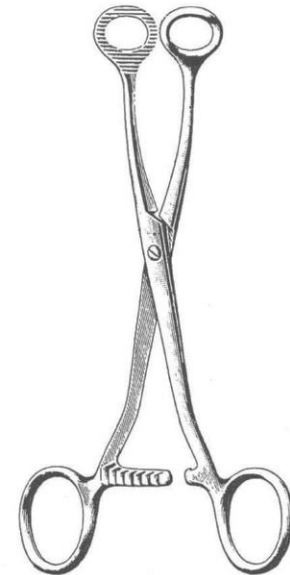

Collin
19-5284-16
16 cm/6¼"



Collin
19-5285-19
19 cm/7½"



19-5286-19
19 cm/7½"



Young
19-5287-17
17 cm/6¾"

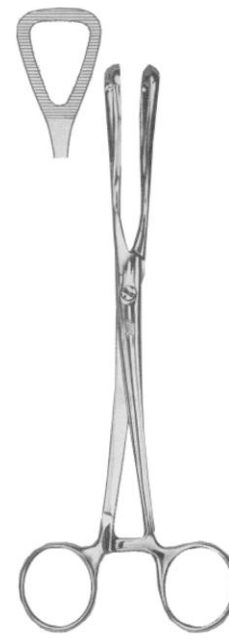

Guys
19-5288-19
19 cm/7½"

Finger Protectors



Lengenbeck

19-5289-01 Ø 22.0 mm

19-5289-02 Ø 24.5 mm

19-5289-03 Ø 26.5 mm

- EN** Tonsil
- DE** Mandel
- ES** Amígdala

Page 468 to 474

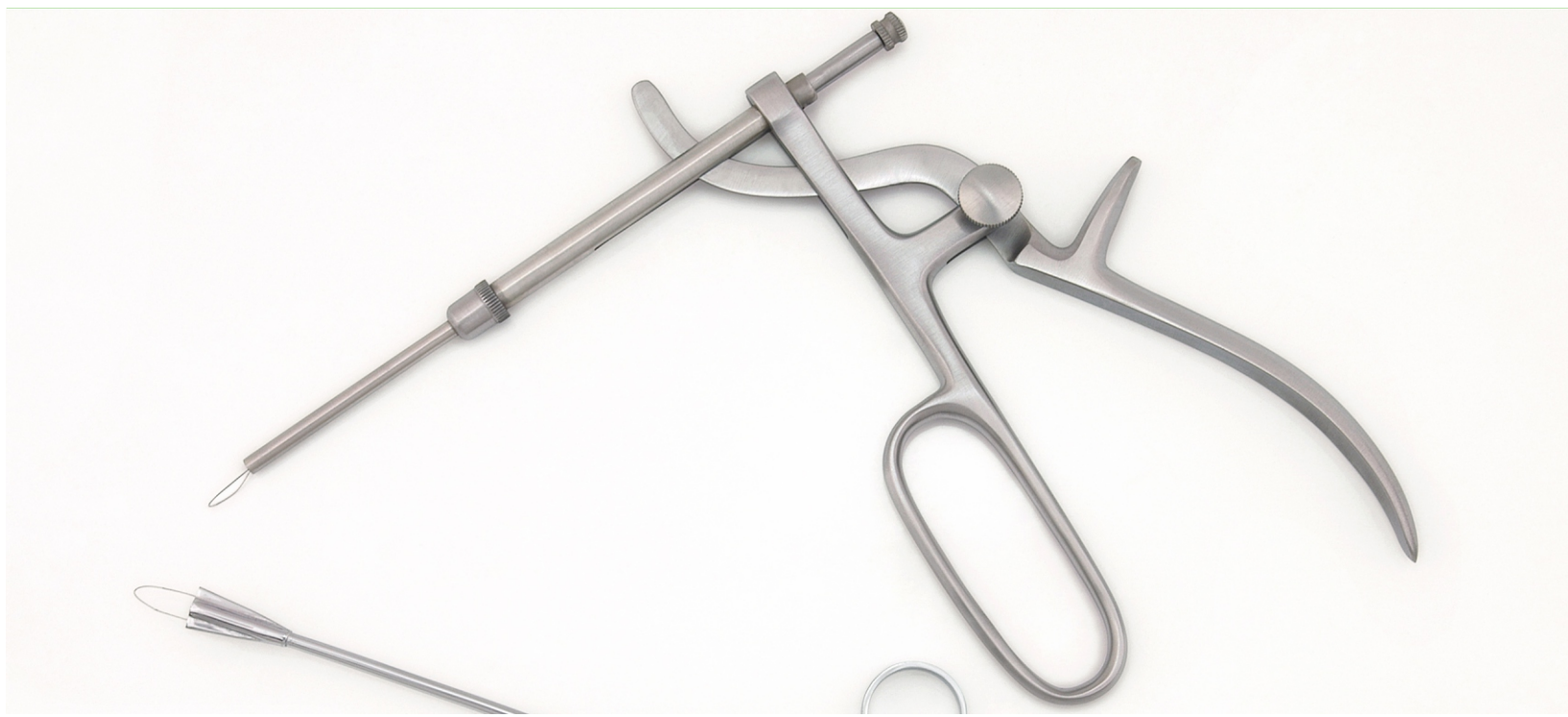

TONSIL

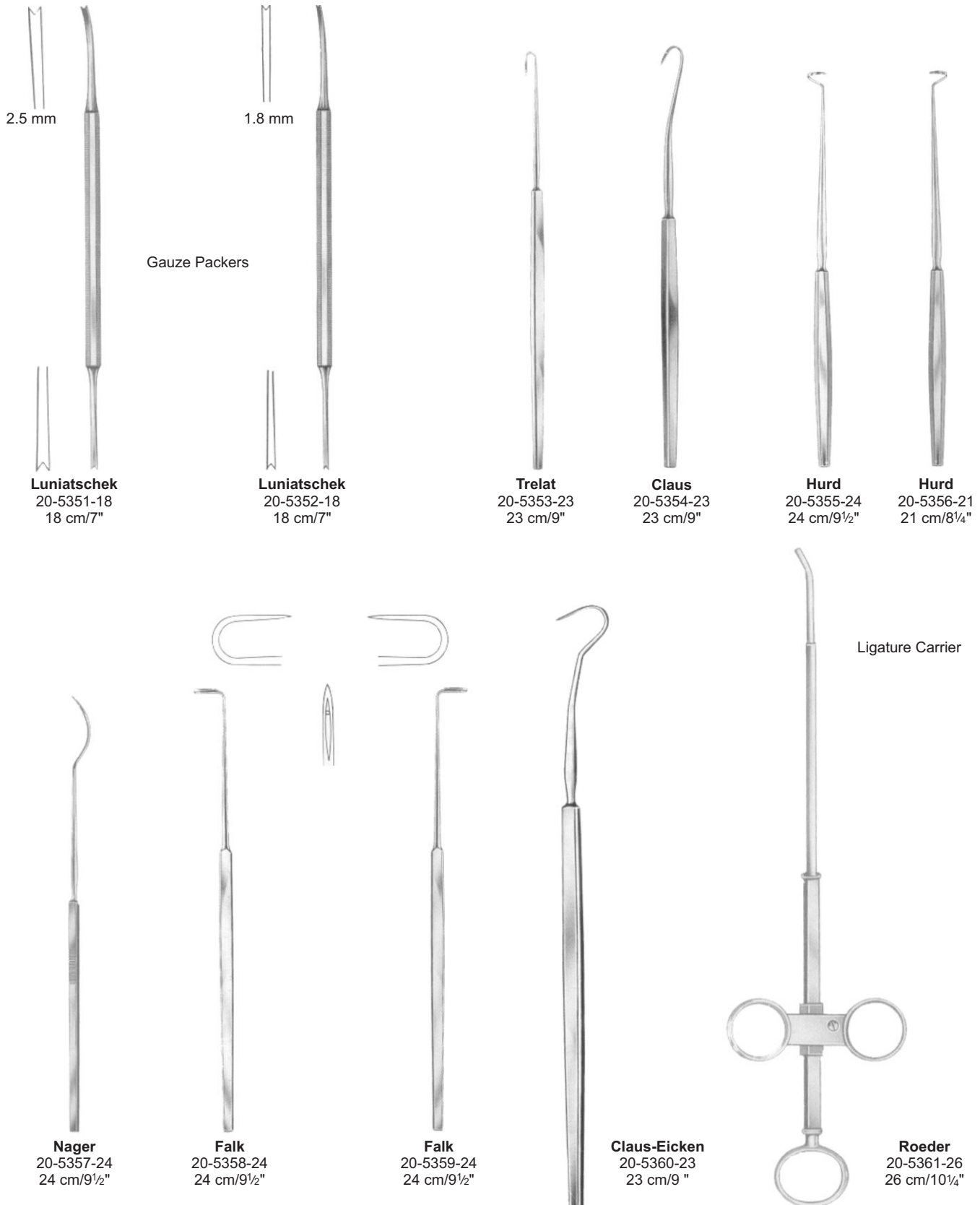

TONSIL

20-5362-17
17.5 cm/6⁷/₈"



Fischer
20-5363-22
22.5 cm/8⁷/₈"



Douglas
20-5364-21
21 cm/8¹/₄"



Abraham
20-5365-21
21 cm/8¹/₄"



Bruenings
20-5366-23
23 cm/9"



Abraham
20-5367-19
19 cm/7¹/₂"



Canfield
20-5368-21
21 cm/8¹/₄"

TONSIL



Negus Knot Tier and Pusher
20-5369-20
20cm/8"



Molison Pillar
double ended
20-5370-21
21cm/8 1/4"



Gwynee Evans Dissector
double ended
20-5371-06
6mm, 20cm/8"
20-5372-06
8mm, 20cm/8"



Hurd
20-5373-22
22.5 cm/8 7/8"



Yankauer
20-5374-21
21 cm/8 1/4"



Luniatschek
20-5375-19
19 cm/7 1/2"



Henke
23 cm/9"



20-5376-01



20-5376-02



Nager
20-5377-23
23 cm/9"



Wide
20-5378-18 18 mm
20-5378-20 20 mm
20-5378-22 22 mm



Love
23 cm/9"



Haslinger
20-5379-16



Hofer
20-5380-24
24 cm/9 1/2"

TONSIL

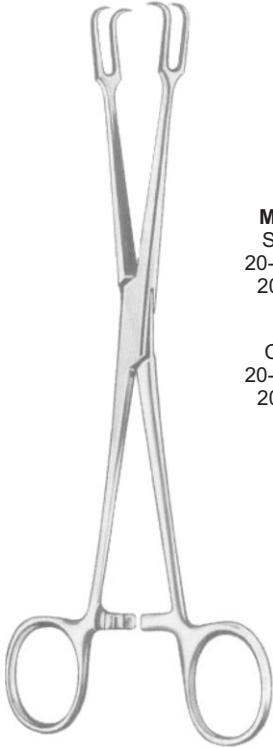

Museux
Straight
20-5381-20
20 cm/8"

Curved
20-5382-20
20 cm/8"



Ballenger
20-5383-21
21.5 cm/8½"



White
20-5384-18 18 cm/7"
20-5384-23 23 cm/9"



Marschik Kroni
20-5385-20
20.5 cm/8"



Colver
Straight
20-5386-19
19 cm/7½"

Curved
20-5387-19
19 cm/7½"



Blohmke
20-5388-20
20 cm/8"

TONSIL



Eves
20-5389-28
28 cm/11"



Eves
20-5390-28
28 cm/11"



Bruenings
20-5391-28
28 cm/11"

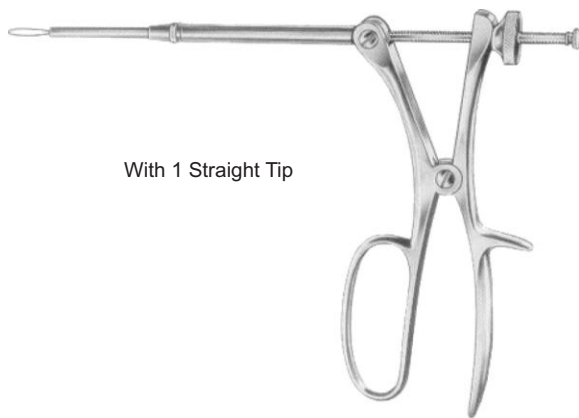

With 1 Straight Tip

Brown
20-5392-00

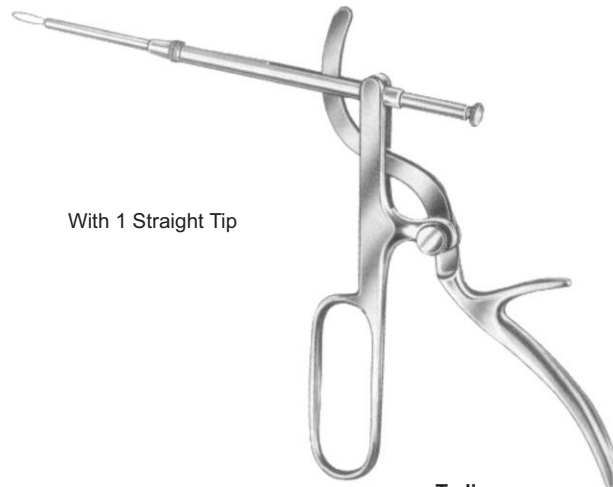

With 1 Straight Tip

Tyding
20-5393-00

TONSIL



Sluder-Ballenger
 Complete, With 3 Tips
 20-5394-00

Tonsil Haemostats



Corwin
 20-5395-14
 14 cm/5½"

Tonsil Punch Forceps



20-5396-13 13 mm Ø
 20-5396-15 15 mm Ø
 20-5396-17 17 mm Ø

Hartmann

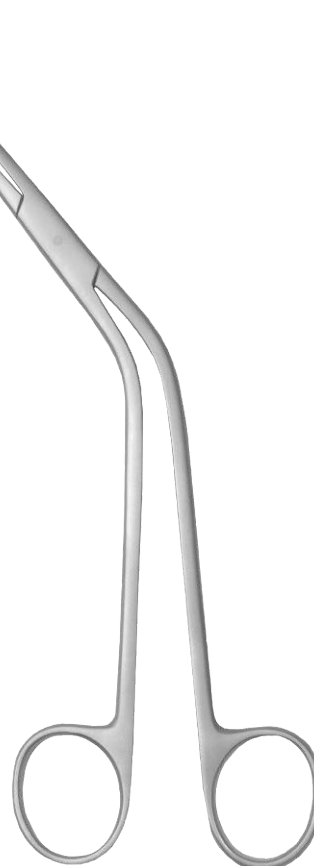

Denis Browne
 Tonsil Forceps
 20-5397-20
 20cm/8"

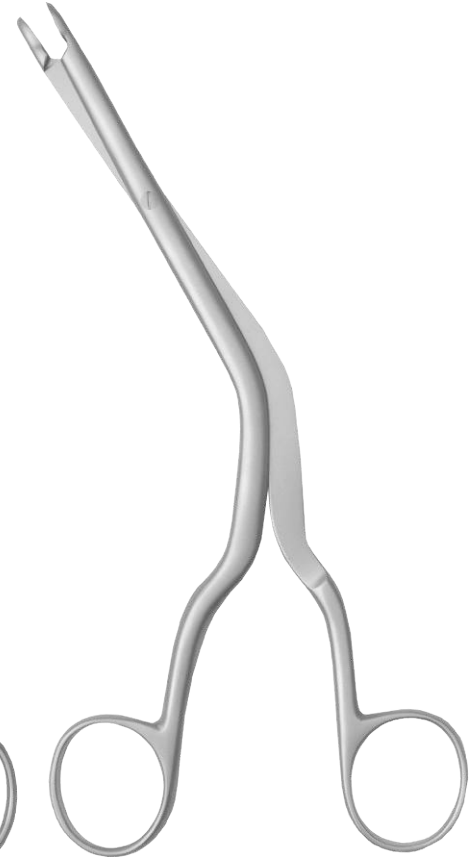

Luc Forceps
 20-5398-20 Small
 20-5399-20 Medium
 20-5400-20 Large
 20cm/8"

TONSIL

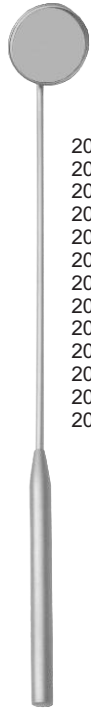

- 20-5401-06 Dia 6mm
- 20-5401-08 Dia 8mm
- 20-5401-10 Dia 10mm
- 20-5401-12 Dia 12mm
- 20-5401-14 Dia 14mm
- 20-5401-16 Dia 16mm
- 20-5401-18 Dia 18mm
- 20-5401-20 Dia 20mm
- 20-5401-22 Dia 22mm
- 20-5401-24 Dia 24mm
- 20-5401-26 Dia 26mm
- 20-5401-28 Dia 28mm
- 20-5401-30 Dia 30mm

Laryngeal Mirror
with metal handle
22cm/8 ¾"



Waugh Dissecting Forcep
20-5402-20
1 x 2 teeth
20cm/8"



Waugh Dissecting Forcep
20-5403-20
serrated
20cm/8"

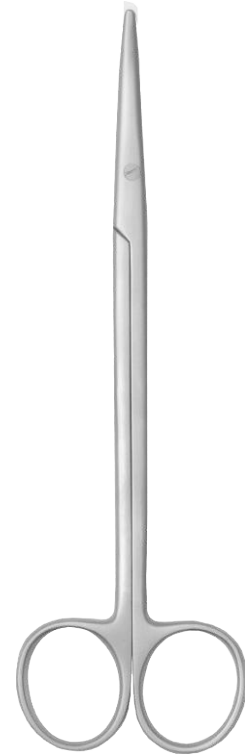

Metzenbaum Scissor Cvd.
20-5404-18
18cm/7"

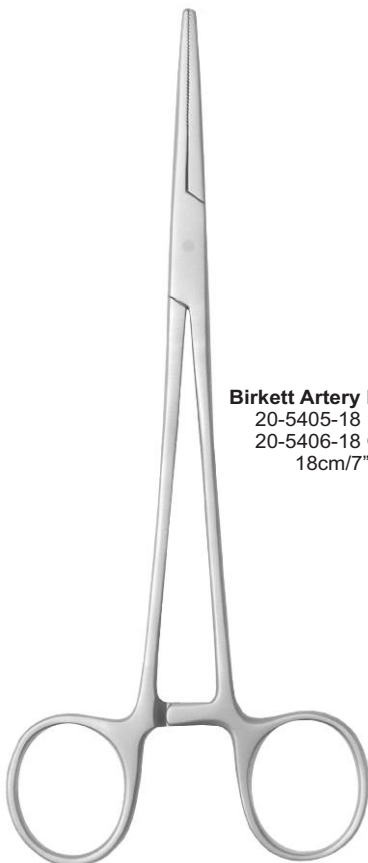

Birkett Artery Forcep
20-5405-18 Str.
20-5406-18 Cvd.
18cm/7"

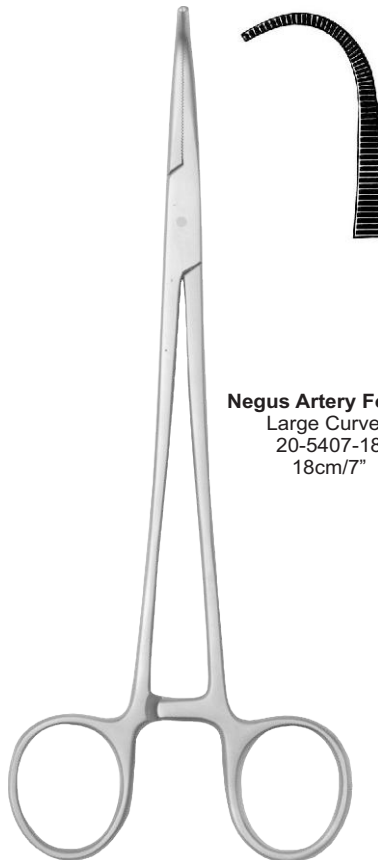

Negus Artery Forcep
Large Curved
20-5407-18
18cm/7"

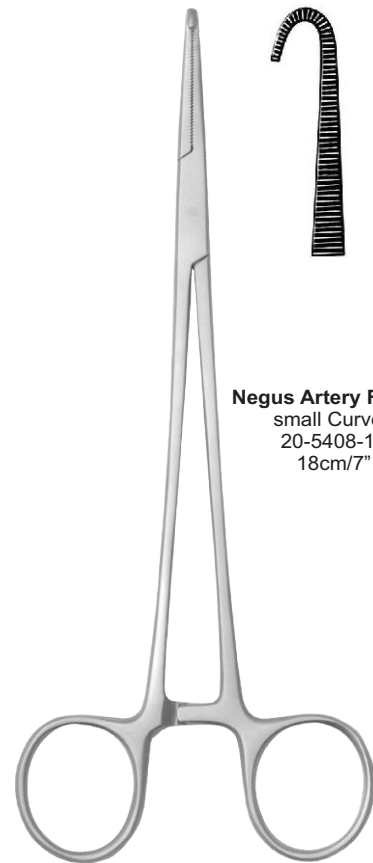

Negus Artery Forcep
small Curved
20-5408-18
18cm/7"

EN Tracheotomy

DE Tracheotomie

ES Traqueotomía

Page 475 to 479



TRACHEOTOMY

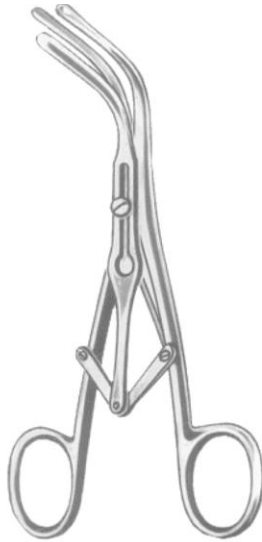

Laborde
21-5551-13 13 cm/5"
21-5551-15 15 cm/6"



Trousseau (Adult)
21-5552-14
14 cm/5½"



Trousseau (Child)
21-5553-13
13 cm/5"

Hooks

Left

Right



Sharp



Bose
21-5554-07
7 cm/2¾"



21-5555-16



21-5556-16

Bose
16 cm/6¼"

Thyroid Gland Retractor



Trachea Trocars



Schoenborn
21-5557-21
21 cm/8¼"

Uckerman
21-5558-08 08 mm Ø
21-5558-10 10 mm Ø
13 cm/5"

TRACHEOTOMY

International scale

Fig.	0	1	2	3	4	5	6	7	8	9
Diameter	④	⑤	⑥	⑦	⑧	⑨	⑩	⑪	⑫	⑬mm
Length of outer tube N	45	50	55	60	65	70	75	80	85	90mm



LUER

Fig	mmØ	45-90mm	95mm	105mm
0	4	21-5559-04		
1	5	21-5559-05		
2	6	21-5559-06		
3	7	21-5559-07		
4	8	21-5559-08	21-5560-08	21-5561-08
5	9	21-5559-09	21-5560-09	21-5561-09
6	10	21-5559-10	21-5560-10	21-5561-10
7	11	21-5559-11	21-5560-11	21-5561-11
8	12	21-5559-12	21-5560-12	21-5561-12
9	13	21-5559-13	21-5560-13	21-5561-13



CHEVALIER-JACKSON

Fig	mmØ	45-90mm
0	4	21-5562-04
1	5	21-5562-05
2	6	21-5562-06
3	7	21-5562-07
4	8	21-5562-08
5	9	21-5562-09
6	10	21-5562-10
7	11	21-5562-11
8	12	21-5562-12
9	13	21-5562-13

TRACHEOTOMY

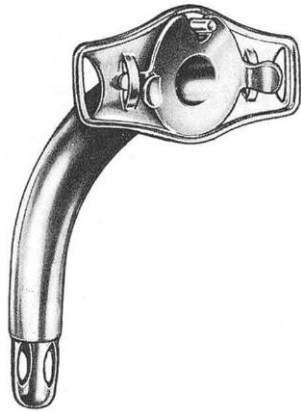

KRISHABER

Fig	mm	
0	4	21-5563-04
1	5	21-5563-05
2	6	21-5563-06
3	7	21-5563-07
4	8	21-5563-08
5	9	21-5563-09
6	10	21-5563-10
7	11	21-5563-11
8	12	21-5563-12



KRISHABER-LUER

Fig	mm	
0	4	21-5564-04
1	5	21-5564-05
2	6	21-5564-06
3	7	21-5564-07
4	8	21-5564-08
5	9	21-5564-09
6	10	21-5564-10
7	11	21-5564-11
8	12	21-5564-12

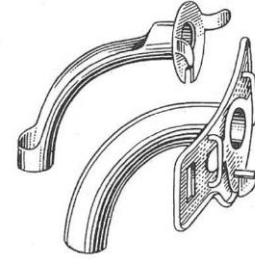

PARKER

Fig	F.G	
1	16	21-5565-16
2	18	21-5565-18
3	20	21-5565-20
4	22	21-5565-22
5	24	21-5565-24
6	26	21-5565-26
7	28	21-5565-28
8	30	21-5565-30
9	32	21-5565-32

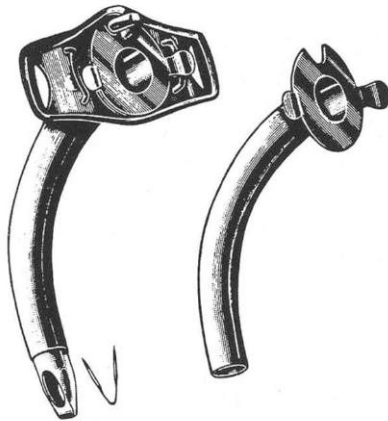

COLLIN

Fig	mm	
0	4	21-5566-04
1	5	21-5566-05
2	6	21-5566-06
3	7	21-5566-07
4	8	21-5566-08
5	9	21-5566-09
6	10	21-5566-10
7	11	21-5566-11
8	12	21-5566-12



FULLER

Fig	F.G	
1	18	21-5567-18
2	20	21-5567-20
3	22	21-5567-22
4	24	21-5567-24
5	26	21-5567-26
6	28	21-5567-28
7	30	21-5567-30
8	32	21-5567-32

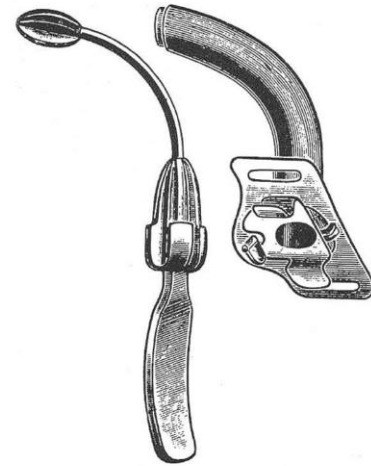

CUBLEY

Fig	F.G	
1	16	21-5568-16
2	18	21-5568-18
3	20	21-5568-20
4	22	21-5568-22
5	24	21-5568-24
6	26	21-5568-26
7	28	21-5568-28
8	30	21-5568-30
9	32	21-5568-32

TRACHEOTOMY

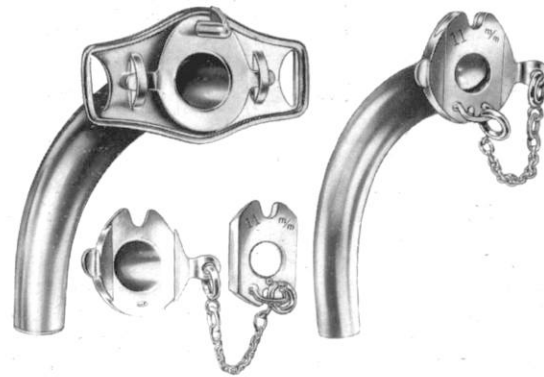
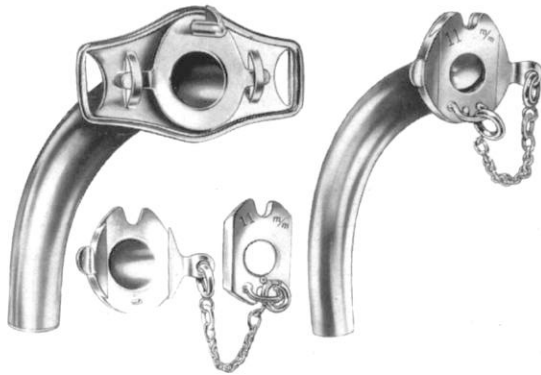
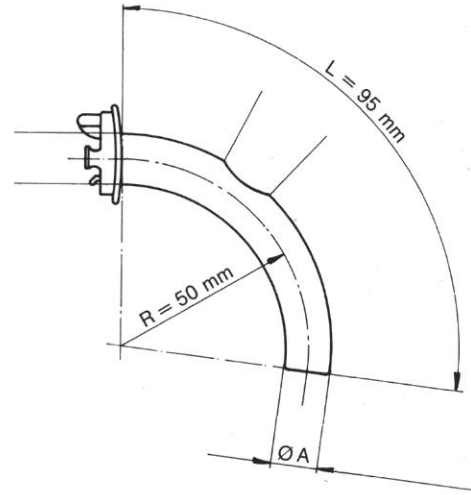
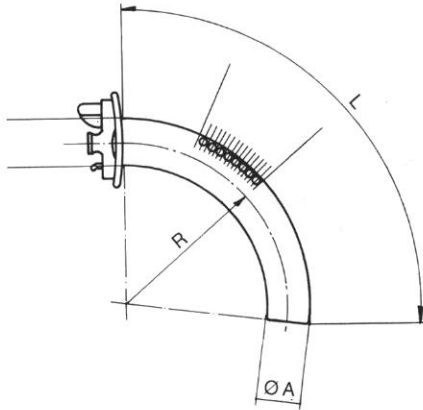
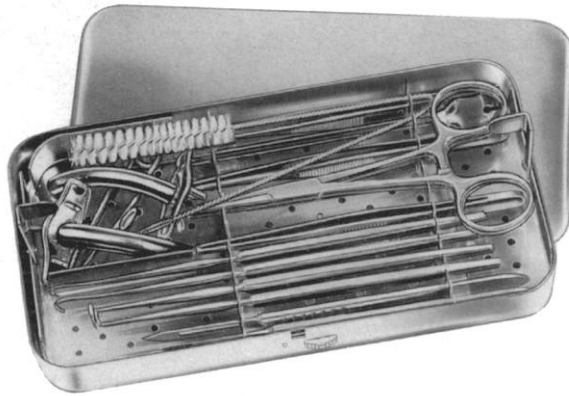

Fig		ØA	L	R
0	21-5569-08	8	65	36.5
1	21-5569-09	9	70	29
2	21-5569-10	10	75	40.5
3	21-5569-11	11	80	41.5
4	21-5569-12	12	85	43
5	21-5569-13	13	90	47.5

Fig		ØA	L	R
0	21-5570-08	8	95	50
1	21-5570-09	9	95	50
2	21-5570-10	10	95	50
3	21-5570-11	11	95	50
4	21-5570-12	12	95	50
5	21-5570-13	13	95	50

TRACHEOTOMY



200 x 105 x 30mm

TRACHEOTOMY SET

21-5571-00

complete in metal case, consisting of:

- 1 Handle with 1 blade, Fig. 20
- 1 Handle with 1 blade, Fig. 23
- 1 Thumb forceps, 13.0cm
- 1 Tissue forcep, 13.0cm 1 x 2 teeth
- 2 Pean Artery Forceps, 13.0cm
- 1 Grooved Director, 14.0cm
- 1 Trachea Dilator
- 2 Iterson Trachea Retractors, blunt
- 1 Bose Trachea Retrector, sharp left hand side
- 1 ditto, right hand side
- 1 Luer Trachea Tube, Standard
- 1 ditto
- 1 Cleaning Brush

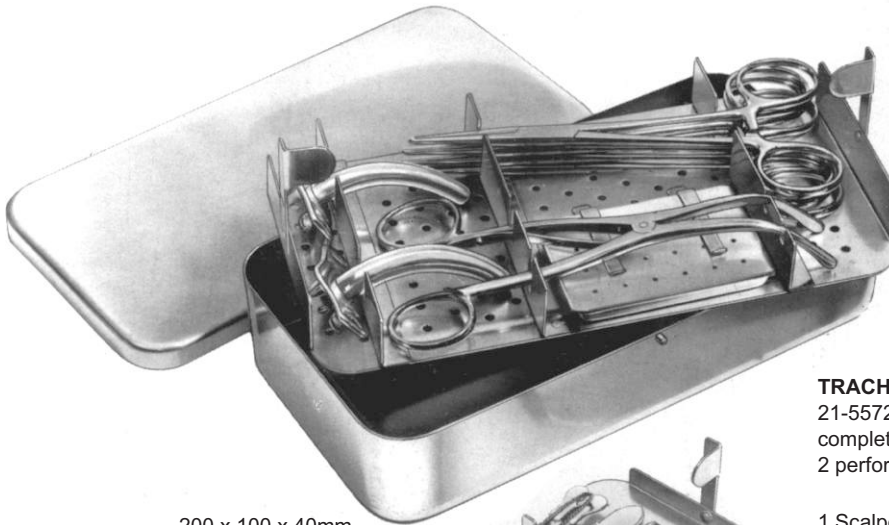

200 x 100 x 40mm

TRACHEOTOMY SET

21-5572-00

complete in metal case 200 x 100 x 40 mm, with
2 perforated trays of 18/8 s/s containing the following instruments:

- 1 Scalpel Handle No. 4, with blade No. 20
- 1 Scalpel Handle No. 4, with blade No. 23
- 3 Scalpel Blades, assorted, in perforated small case.
- 1 Small case for above Scalpel Blades
- 1 Dressing Forceps, serrated, 13.0cm
- 2 Tissue Forceps, 1 x 2 teeth, 13.0cm
- 4 Crile Artery Forceps, straight, 14.0cm
- 1 Grooved Director, 14.0cm
- 1 Trousseau Trachea Dilator, 14.0cm
- 2 Iterson Trachea Hooks, blunt
- 1 Bose Hook, sharp, left hand side, 16.0cm
- 1 ditto, right hand side, 16.0cm
- 1 Luer Trachea Tube, size 2.6mm diam.
German Silver.
- 1 ditto, size 4.8mm diam, German Silver.
- 1 Cleaning Brush, 12mm diam. 26.0cm

- EN** Goitre
DE Kropfchirurgie
ES Bocio

Page 480

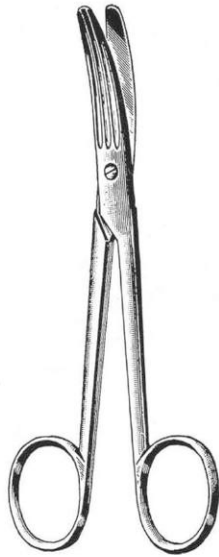

GOITRE

SCHOEMAKER
22-5601-15 15.0cm

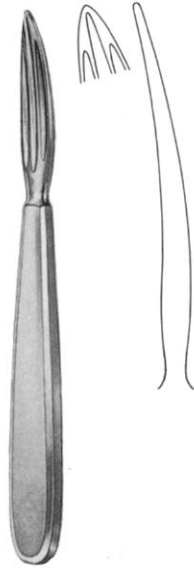

KOCHER
22-5602-15 15.0cm
22-5602-16 16.0cm

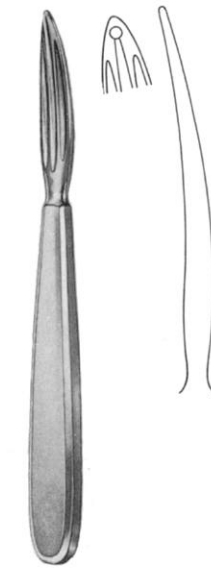

KOCHER
22-5603-15
22-5603-16

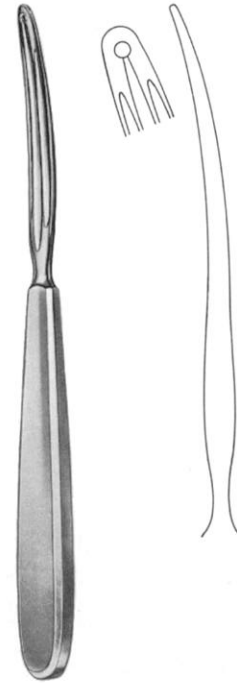

KOCHER
22-5604-18 18.0cm

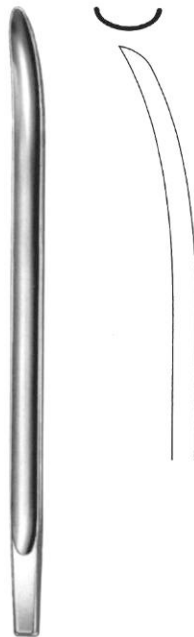

HOFMEISTER
22-5605-21 21.0cm



LAHEY
22-5606-15 15.0cm
22-5606-20 20.0cm

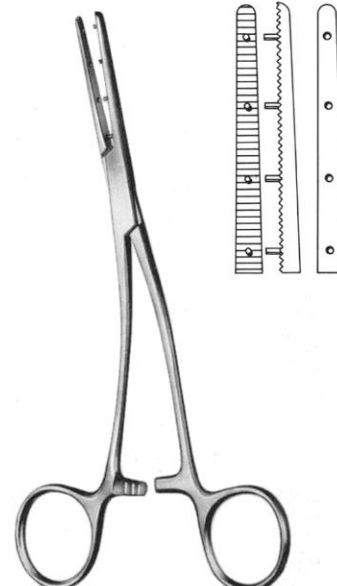

MASTIN
22-5607-17 17.0cm

- EN** Dermatology
- DE** Dermatologie
- ES** Dermatología

Page 481 to 482



DERMATOLOGY

Comedone Extractors

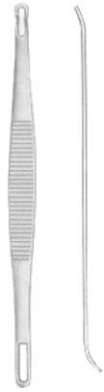

Schamberg
23-5751-10
10 cm/4"



Unna
23-5752-14
14 cm/5½"



Unna
23-5753-14
14 cm/5½"



Sealfield
23-5754-10
10 cm/4"



Saalfeld
23-5755-14
14 cm/5½"



Katsch
23-5756-14
14 cm/5½"



Hebra
23-5757-18
18 cm/7"

Skin Curettes



Fig. 1 23-5758-01



Fig. 2 23-5758-02



Fig. 3 23-5758-03



Piffard
14.5cm/5¾"

DERMATOLOGY

Lupus Curettes



Wolff
14 cm/5½"

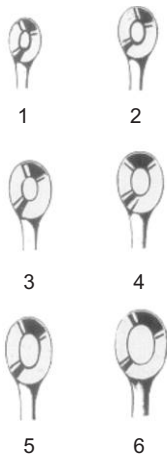

Fig.
 1 23-5759-01
 2 23-5759-02
 3 23-5759-03
 4 23-5759-04
 5 23-5759-05
 6 23-5759-06

Lupus Curettes



Fox
14 cm/5½"



Lupus Scraper



Vidal
23-5761-14
14 cm/5½"



Moncorps Knife



Moncorps
23-5762-14
14 cm/5½"



Gillies
 Fig. 1 23-5763-01
 Fig. 2 23-5763-02
 18 cm/7"



Cutaneous Hook



Kilner
23-5764-15
15 cm/6"

EN Stomach, Intestine, Rectum

DE Magen, Darm, Mastdarm

ES Estómago, Intestinos, Recto

Page 483 to 504



STOMACH, INTESTINE & RECTUM



Allis

cm	in	4 : 5	5 : 6
15	6"	24-5801-15	24-5802-15
19	7½"		24-5802-19
23	9"		24-5802-23
25	10"		24-5802-25



Baby-Allis

24-5803-12	12 cm/4¾"
24-5803-14	14 cm/5½"

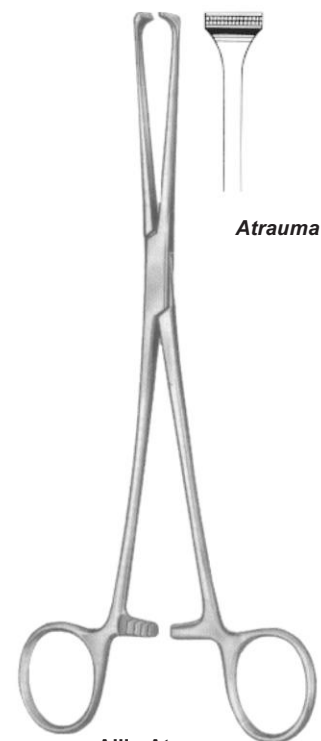

Allis-Atrauma

24-5804-16	16 cm/6¼"
24-5804-20	20 cm/8"
24-5804-25	25 cm/10"
24-5804-30	30 cm/12"

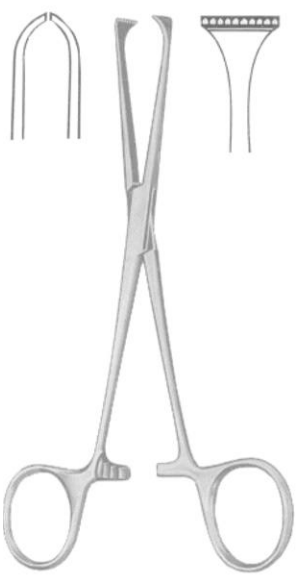

Allis-Adair
 24-5805-15
 15 cm/6"



Baby-Allis
 24-5806-15
 15 cm/6"



Lockwood-Allis
 24-5807-16 16 cm/6¼"
 24-5807-20 20 cm/8"



Thoms-Allis
 24-5808-20
 20 cm/8"

STOMACH, INTESTINE & RECTUM

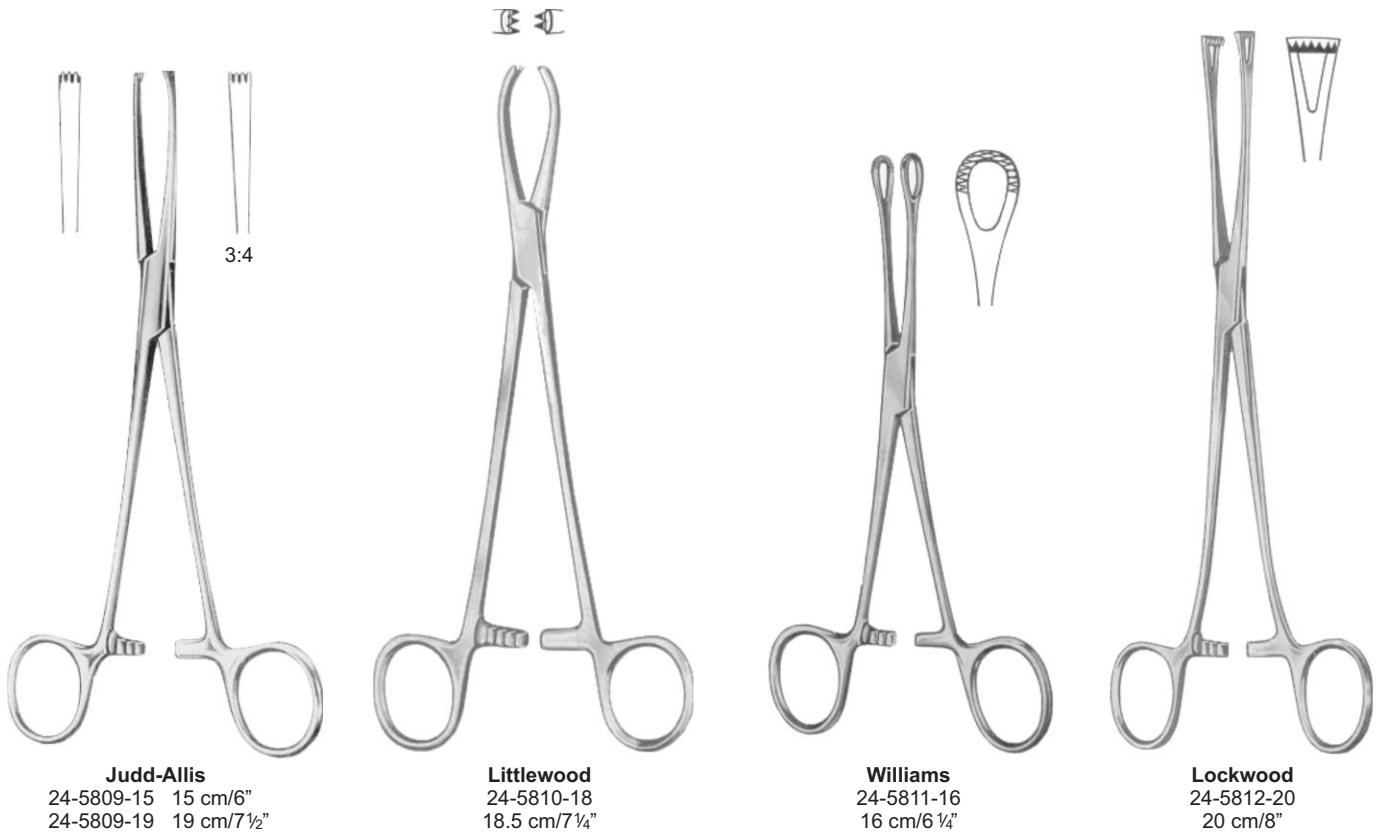

Atrauma

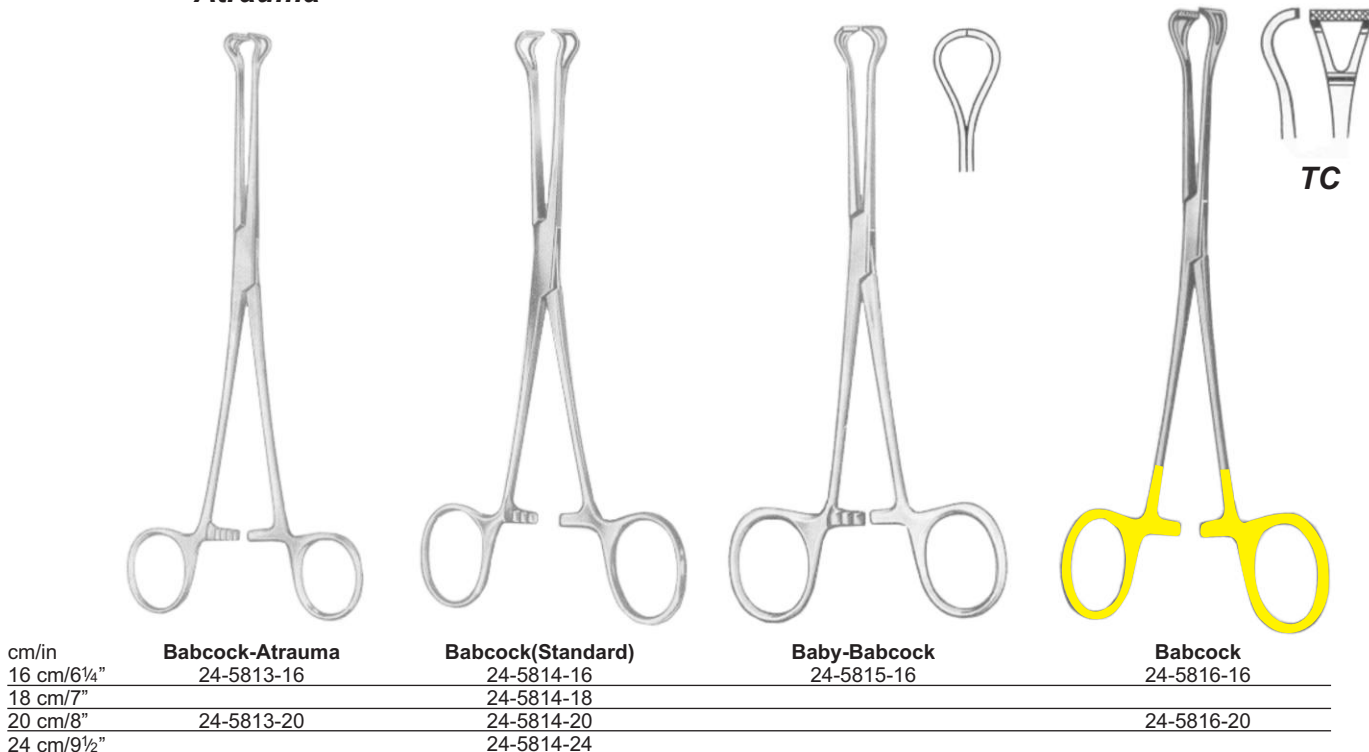

cm/in
16 cm/6¼"
18 cm/7"
20 cm/8"
24 cm/9½"

STOMACH, INTESTINE & RECTUM

Atrauma

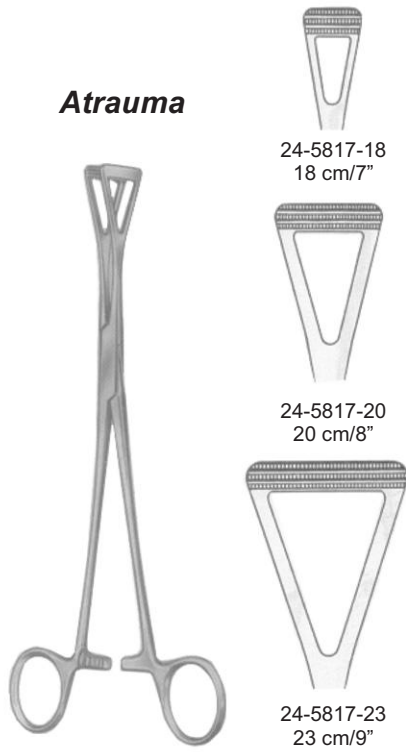

	Duval		
	cm	in	
24-5818-18	18	7"	
24-5818-20	20	8"	24-5819-20
24-5818-23	23	9"	24-5819-23

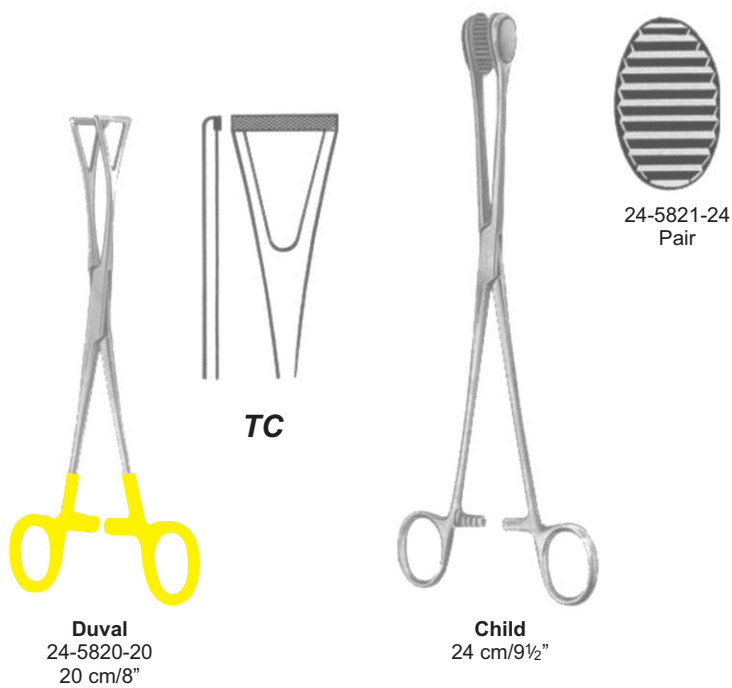

Atrauma

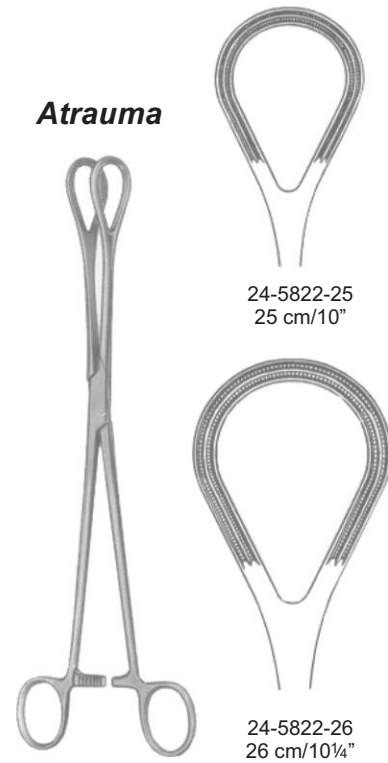

STOMACH, INTESTINE & RECTUM

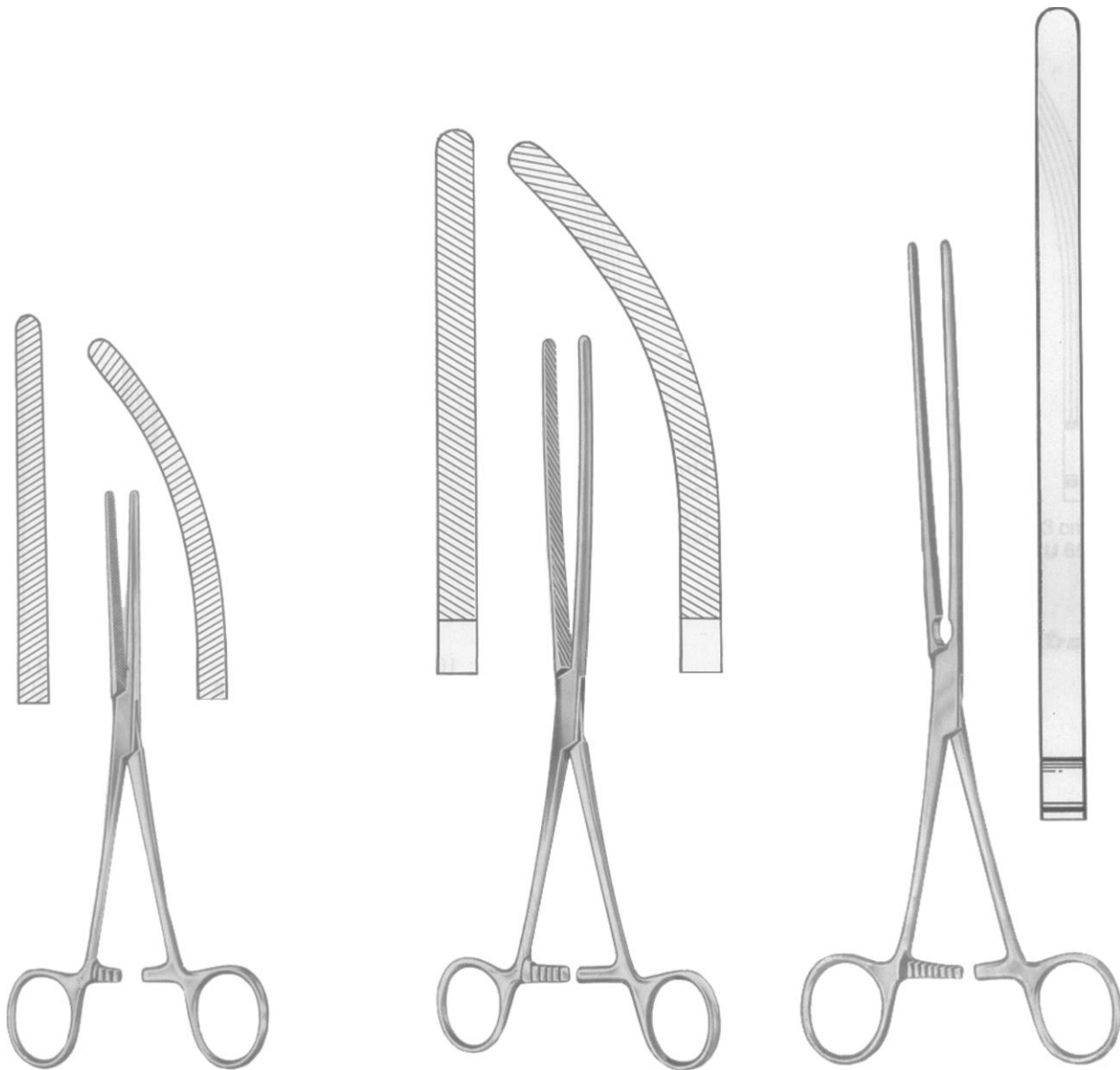

Baby-Doyen
 Straight 24-5823-18 18 cm/7"
 Curved 24-5824-18 18 cm/7"

Doyen
 Straight 24-5825-21 21 cm/8 ¼"
 24-5825-23 23 cm/9"
 Curved 24-5826-21 21 cm/8 ¼"
 24-5826-23 23 cm/9"

Scudder
 24-5827-25 25 cm/10"

STOMACH, INTESTINE & RECTUM

Atrauma

Straight



Doyen-Atrauma

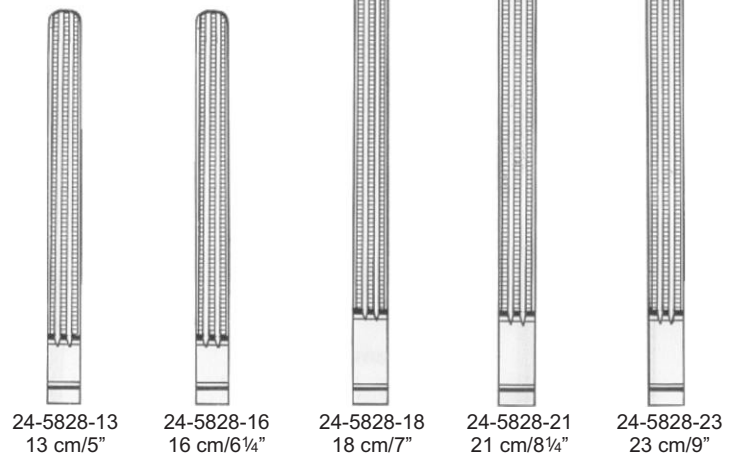

Atrauma

Curved

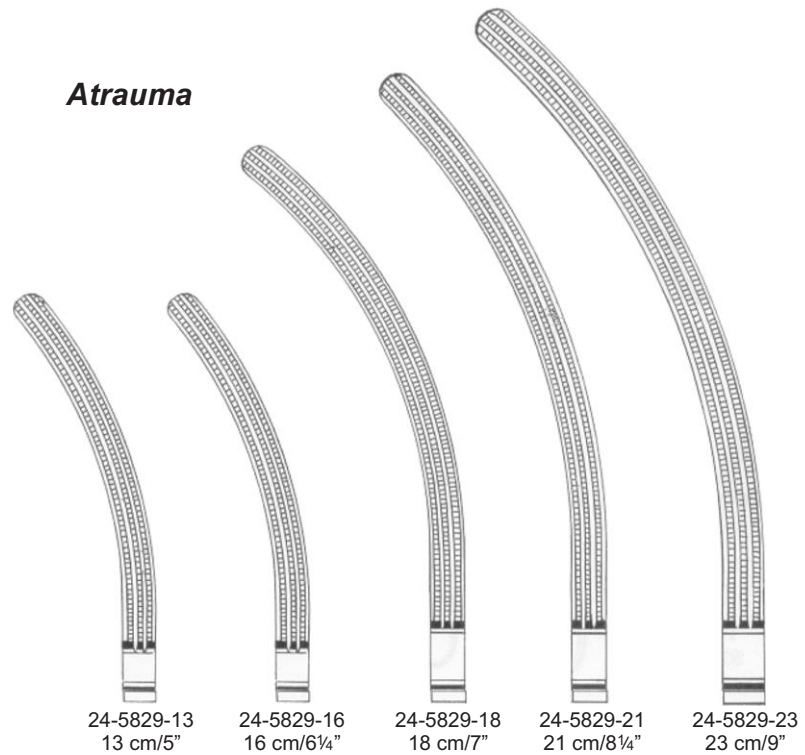

STOMACH, INTESTINE & RECTUM



Mayo-Robson
Mayo-Robson Atrauma



24-5830-21
 21 cm/8¼"



24-5831-21
 21 cm/8¼"



24-5832-23
 23 cm/9"



24-5833-23
 23 cm/9"

Atrauma



24-5834-25
 25 cm/10"

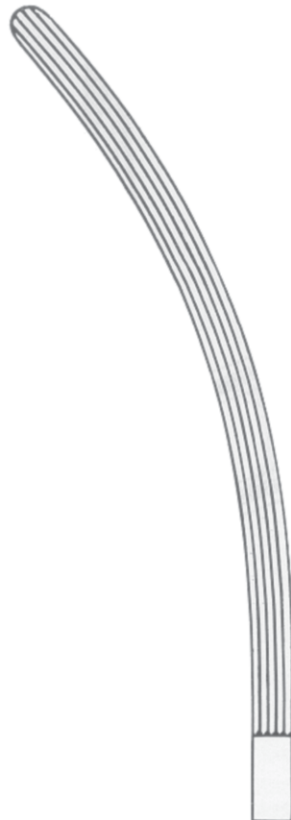

24-5835-25
 25 cm/10"



24-5836-25
 25 cm/10"

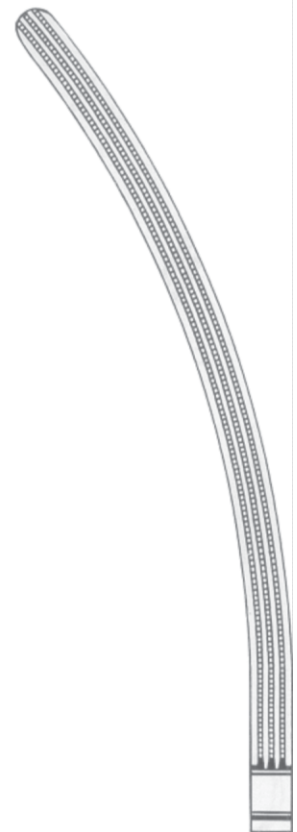

24-5837-25
 25 cm/10"

STOMACH, INTESTINE & RECTUM



Resano
24-5838-30
30 cm/12"



Hayes



24-5839-26
26 cm/10 1/4"

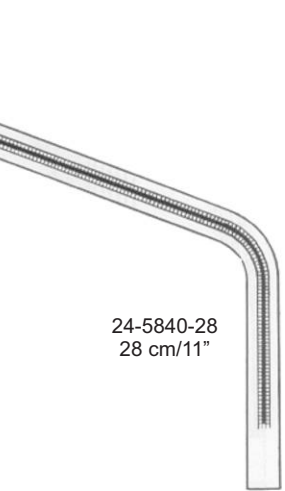

24-5840-28
28 cm/11"

Atrauma



Fehland
24-5841-24
24 cm/9 1/2"



Brunner
24 cm/9 1/2"



24-5842-24

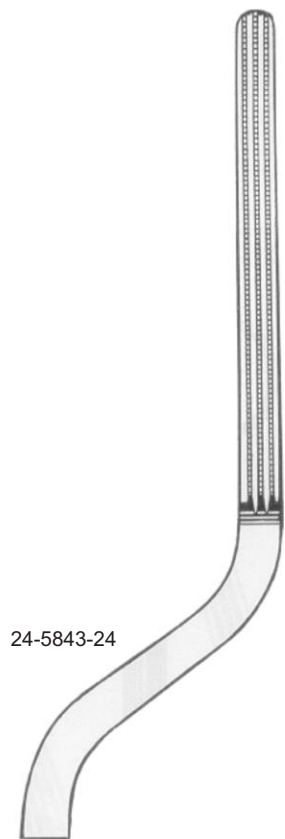

24-5843-24

Atrauma

STOMACH, INTESTINE & RECTUM



Baby-Kocher
 Straight 24-5844-13 13 cm/5"
 Curved 24-5845-13 13 cm/5"



Kocher



24-5846-22
 22 cm/8¾"



24-5846-25
 25 cm/10"



24-5846-28
 28 cm/11"



24-5847-22
 22 cm/8¾"



24-5847-25
 25 cm/10"

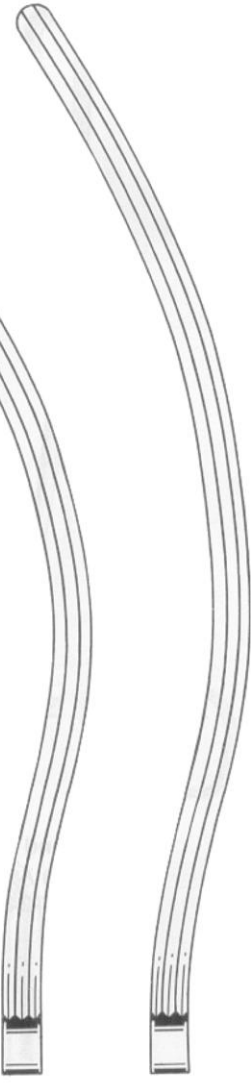

24-5847-28
 28 cm/11"

STOMACH, INTESTINE & RECTUM

Atrauma



Kocher-Atrauma

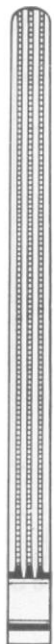

24-5848-22
22 cm/8¾"

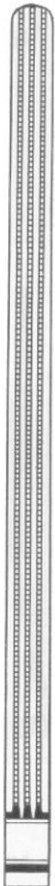

24-5848-25
25 cm/10"



24-5848-28
28 cm/11"



24-5849-22
22 cm/8¾"



24-5849-25
25 cm/10"



24-5849-28
28 cm/11"

STOMACH, INTESTINE & RECTUM

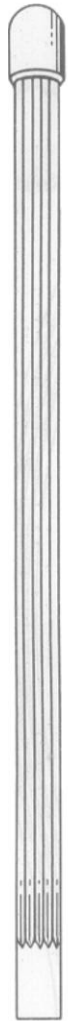

Straight
24-5851-25



Nussbaum
25 cm/10"



Curved
24-5852-25



Pylorus spreader

Benson
24-5850-15
15.5 cm/6"

Blindgut forceps



Allen
24-5853-15 15.5 cm/6"
24-5853-20 20.0 cm/8"



Kleinschmidt
24-5854-12
12 cm/4¾"

STOMACH, INTESTINE & RECTUM



Payr
(Payr-Baby)

For children

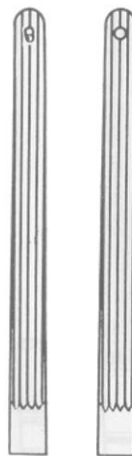

24-5855-15
15 cm/6"

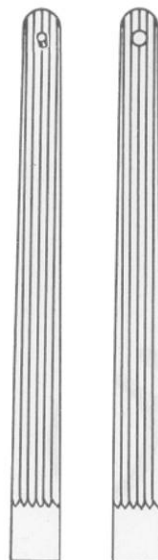

24-5856-21
21 cm/8¼"

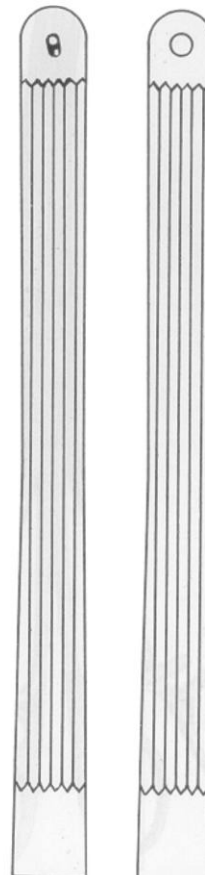

24-5857-29
29 cm/11½"

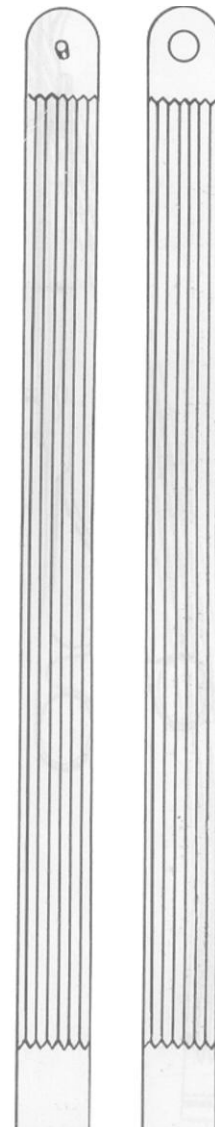

24-5858-35
35 cm/13¾"

STOMACH, INTESTINE & RECTUM

Twin Clamps Forceps

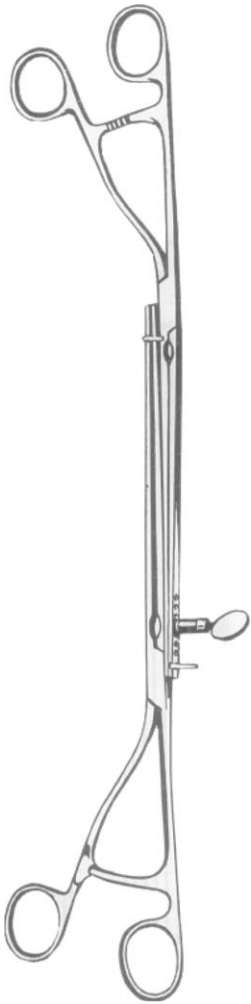

Lane
 30 cm/12"

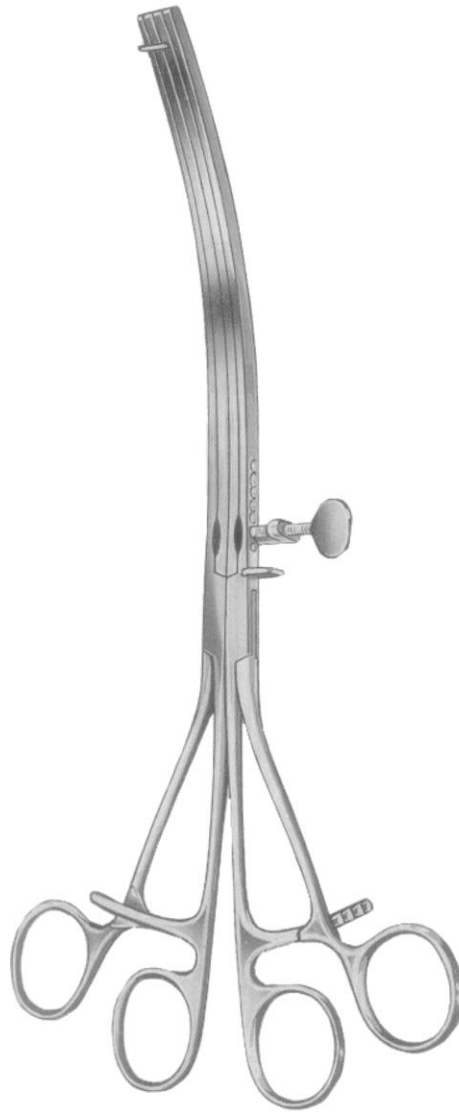

Straight
 24-5859-30

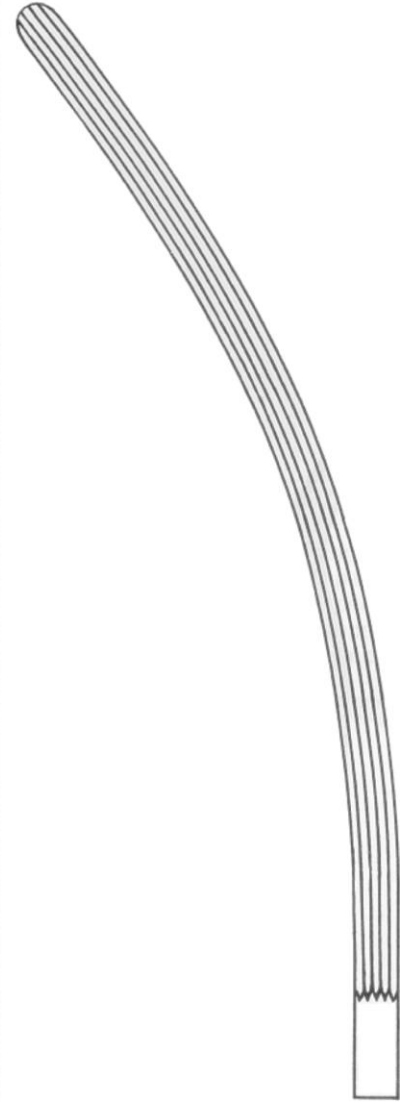

Curved
 24-5860-30

STOMACH, INTESTINE & RECTUM

Atrauma



STOMACH, INTESTINE & RECTUM

Intestinal and Stomach Twin Clamps

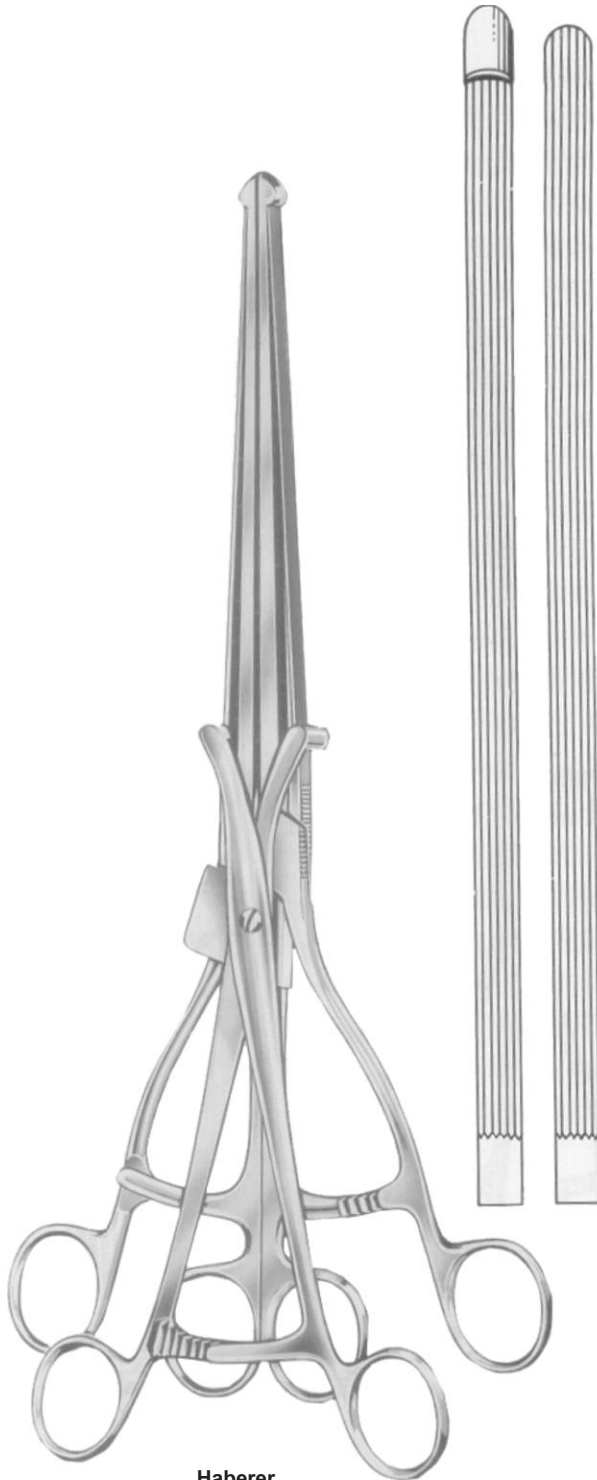

Haberer
 24-5865-36
 36 cm/14"

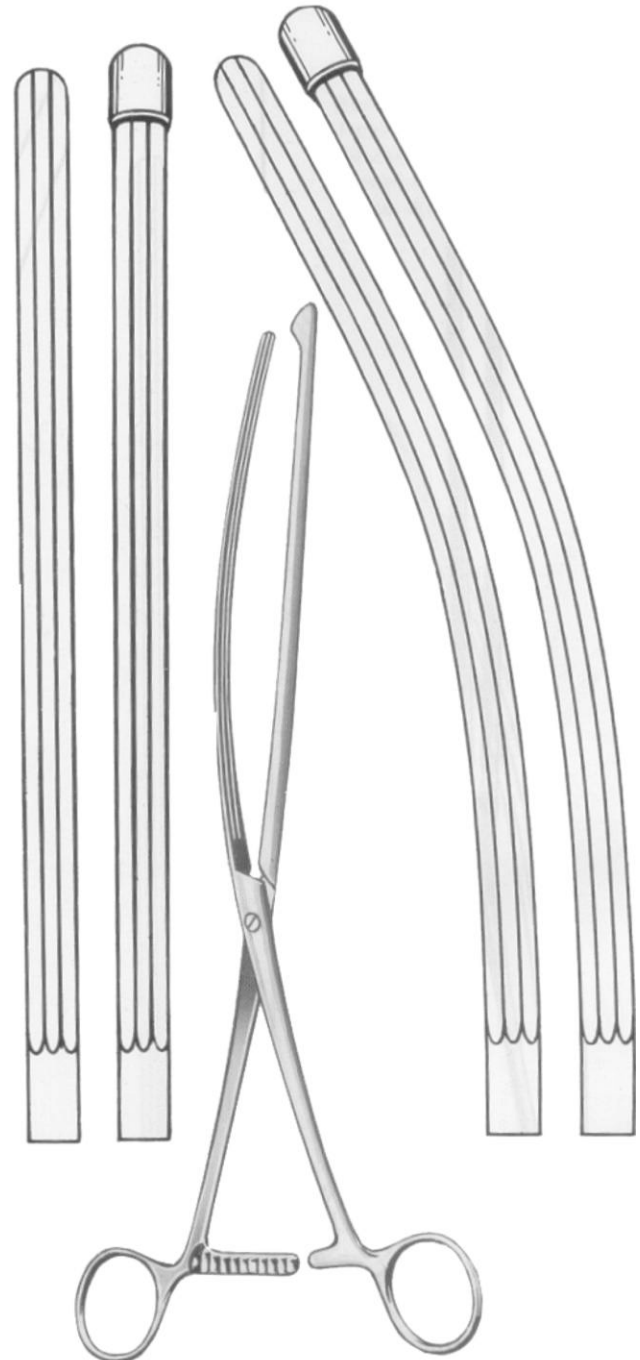

Straight
 24-5866-30

Nussbaum
 30 cm/12"

Curved
 24-5867-30

STOMACH, INTESTINE & RECTUM



Czerny
24-5868-22
22 cm/8¾"

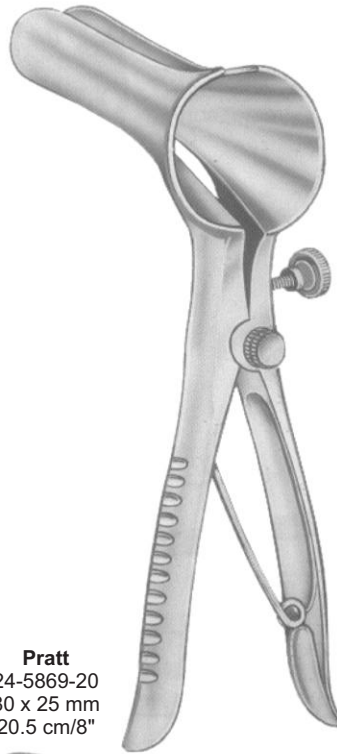

Pratt
24-5869-20
80 x 25 mm
20.5 cm/8"



Sims
25-08291-15

(Bodenhammer) Sims
24-5870-15
15 cm/6"

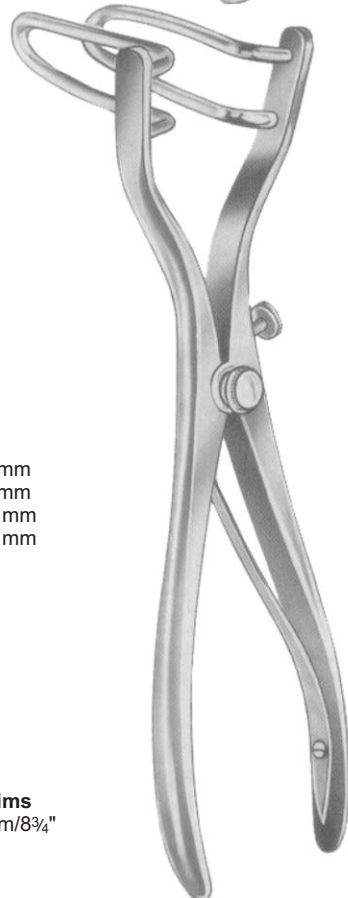

Sims
22 cm/8¾"

Length of Blades
24-5871-06
24-5871-08
24-5871-12
24-5871-15

60 mm
80 mm
125 mm
150 mm

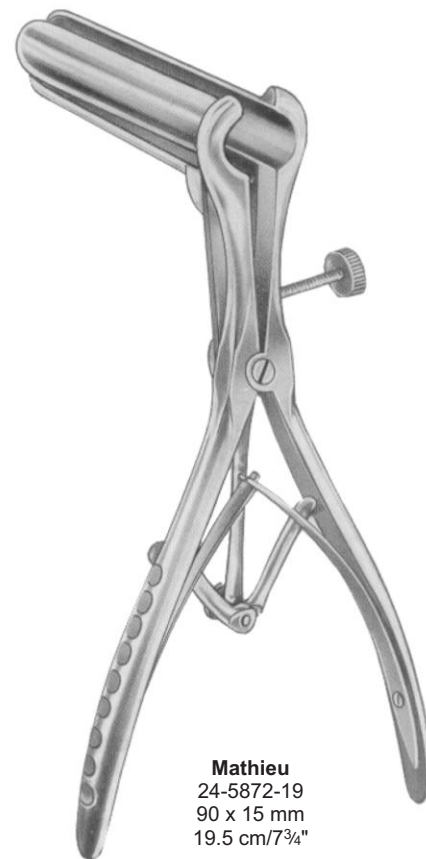

Mathieu
24-5872-19
90 x 15 mm
19.5 cm/7¾"

STOMACH, INTESTINE & RECTUM



Barr
 24-5873-17
 17 cm/6¾"
 70 X 22 mm

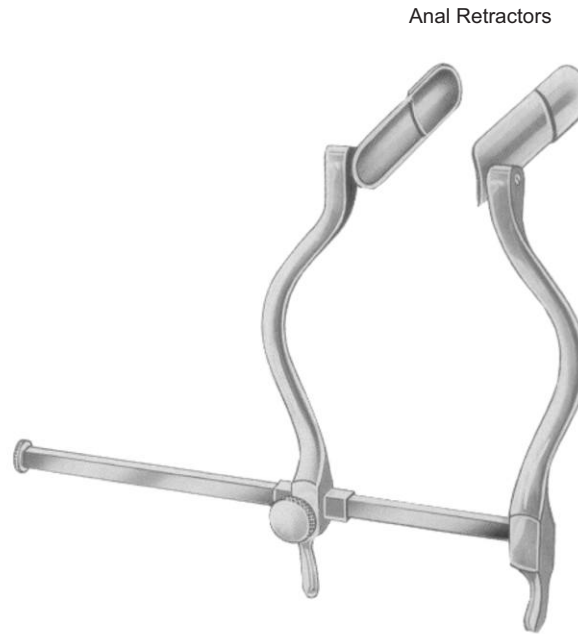

Smith-Bule
 24-5874-15
 15 cm/6"

Anusscopes



Hirschmann
 Fig. 1 16 mm Ø x 65 mm 24-5875-01
 Fig. 2 19 mm Ø x 65 mm 24-5875-02
 Fig. 3 22 mm Ø x 65 mm 24-5875-03
 Fig. 4 25 mm Ø x 65 mm 24-5875-04



Bensaude
 Fig. 1 19 mm Ø x 70 mm 24-5876-01
 Fig. 2 22 mm Ø x 70 mm 24-5876-02

STOMACH, INTESTINE & RECTUM

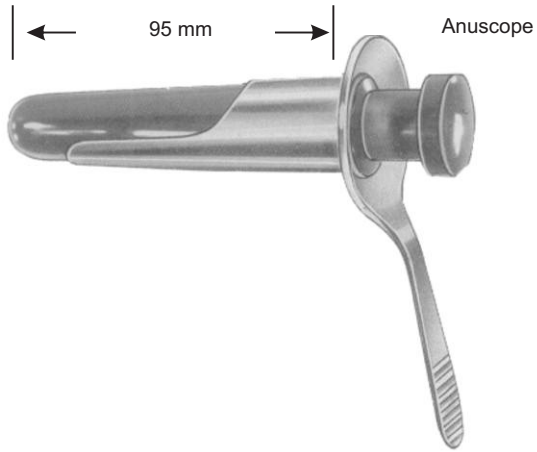

Ives-Fansler
24-5877-22
22 mm Ø

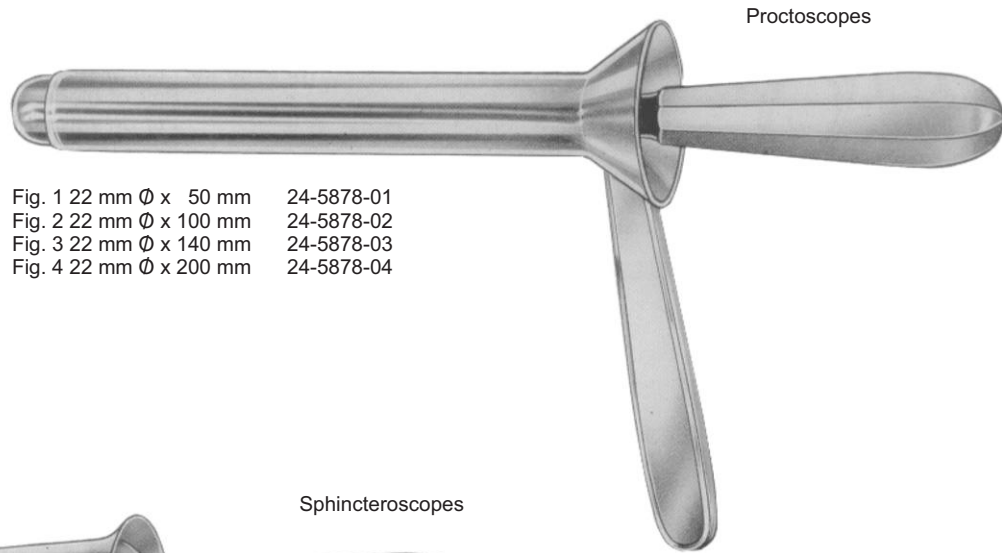

Fig. 1 22 mm Ø x 50 mm 24-5878-01
Fig. 2 22 mm Ø x 100 mm 24-5878-02
Fig. 3 22 mm Ø x 140 mm 24-5878-03
Fig. 4 22 mm Ø x 200 mm 24-5878-04

Kelly



Kelly

Fig. 1 21 mm Ø 50 mm 24-5879-01
Fig. 2 27 mm Ø 50 mm 24-5879-02

STOMACH, INTESTINE & RECTUM

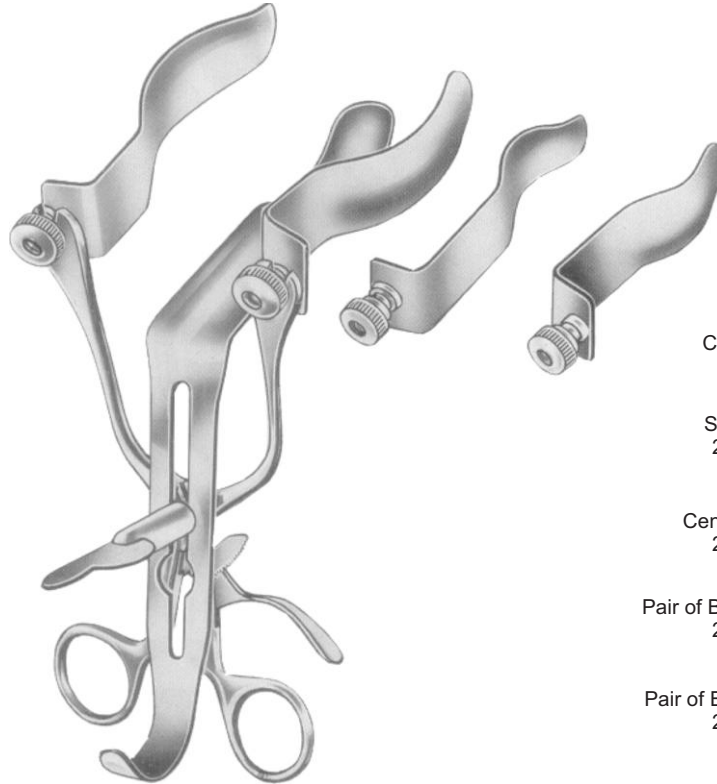

Park
 24-5880-00
 14.5 cm/5¾"

Consisting of:

Spreader only
 24-5880-01

Center Blade only
 24-5880-02

Pair of Blades Only 75 mm
 24-5880-03

Pair of Blades only 95 mm
 24-5880-04

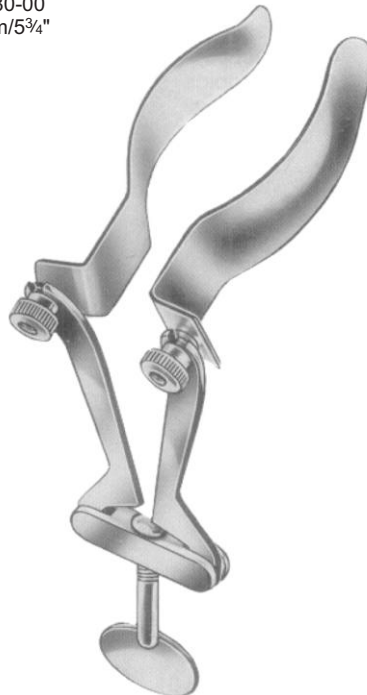

Park
 24-5881-00
 13 cm/5"

Consisting of:

Spreader only
 24-5881-01

Pair of Blades only 95 mm
 24-5881-02

STOMACH, INTESTINE & RECTUM

Length of Shaft

		Length of Shaft			
		cm	in		
1	2	28	11	Yeoman	
24-5882-28	24-5883-28	35	13¾"		
24-5882-35	24-5883-35	42	16½"		
3	4				
24-5882-42	24-5883-42	24-5884-28	24-5885-28		
24-5882-35	24-5883-35	24-5884-35	24-5885-35		
24-5882-42	24-5883-42	24-5884-42	24-5885-42		

Length of Shaft

Turnable

	Length of Shaft		Forceps Complete	Attachment Only
	cm	in		
	33	13	24-5886-33	24-5890-33
	40	16	24-5886-40	24-5890-40
	33	13	24-5887-33	24-5891-33
	40	16	24-5887-40	24-5891-40
	33	13	24-5888-33	24-5892-33
	40	16	24-5888-40	24-5892-40
	33	13	24-5889-33	24-5893-33
	40	16	24-5889-40	24-5893-40

Yeoman (Turrell)
 Handle Only
 24-5894-00

STOMACH, INTESTINE & RECTUM

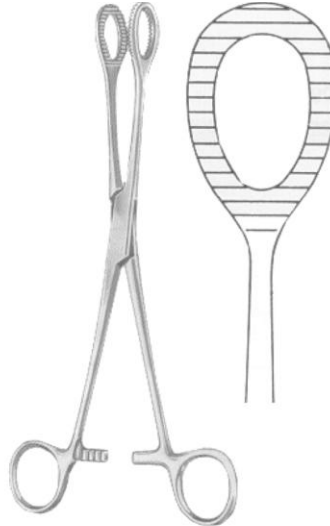

Heywood-Smith
24-5895-21
21 cm/8¼"

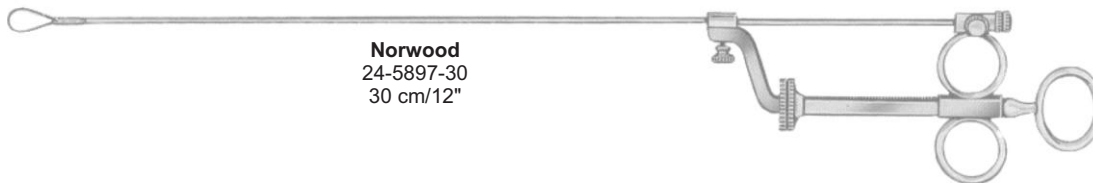

Heywood-Smith
24-5896-21
21 cm/8¼"

Rectal Snare

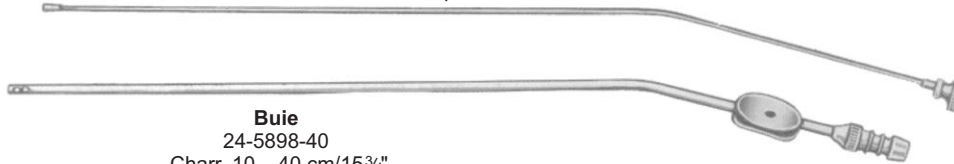
Norwood
24-5897-30
30 cm/12"

Rectal Aspiration Cannula

Buie
24-5898-40
Charr. 10. 40 cm/15¾"

Rectal Coolers



24-5899-01



24-5900-02

STOMACH, INTESTINE & RECTUM

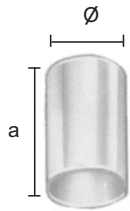
Aspiration Tip



	a	ø
24-5901-11	11 mm	10 mm
24-5901-16	16 mm	10 mm

Charging Cone



10 mm ø

24-5902-10

Charging Cone



12 mm ø

24-5903-12

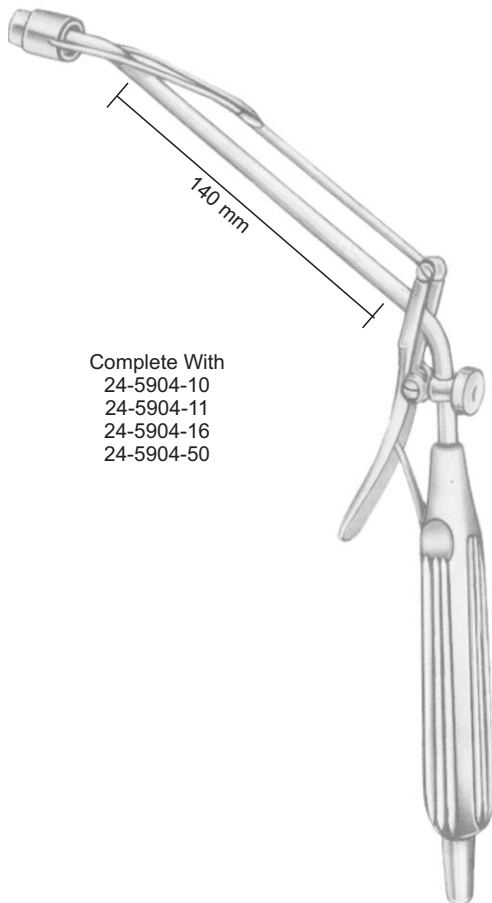

Complete With
 24-5904-10
 24-5904-11
 24-5904-16
 24-5904-50

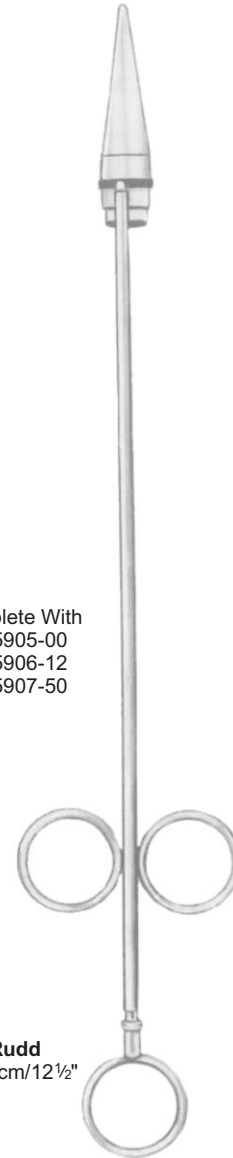

Complete With
 24-5905-00
 24-5906-12
 24-5907-50

Rudd
 31.5 cm/12½"

STOMACH, INTESTINE & RECTUM

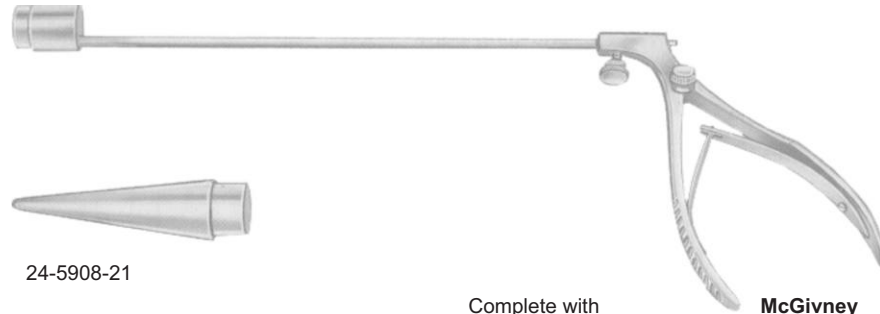

24-5908-21

Complete with
24-5908-00

McGivney
24-5908-01

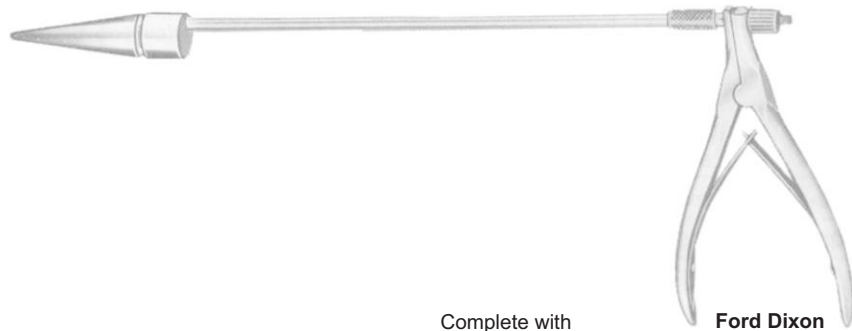

Complete with
24-5909-00

Ford Dixon
24-5909-01

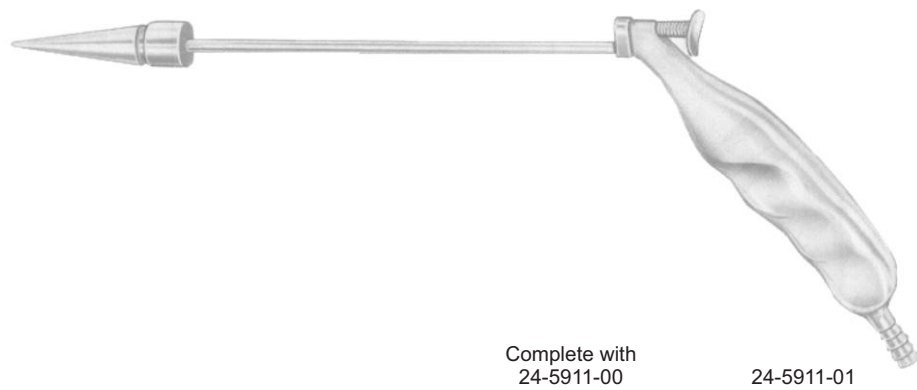

Complete with
24-5911-00

24-5911-01

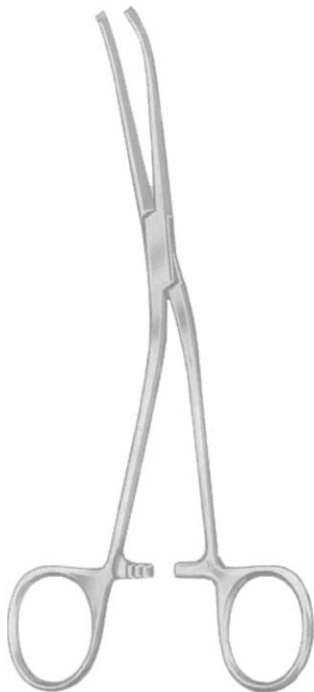

McGivney
24-5910-19
19 cm/7½"



24-5912-00
Ligator rubber rings
in box of 100 pieces

EN Kidney, Liver, Gall Stone, Urology

DE Niere, Leber, Galle, Urologie

ES Riñón, Hígado, Bilis, Urología

Page 505 to 518



KIDNEY, UROLOGY INSTRUMENTS



Guyon

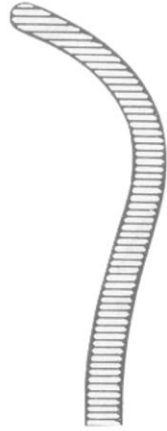

25-6001-20
20 cm/8"

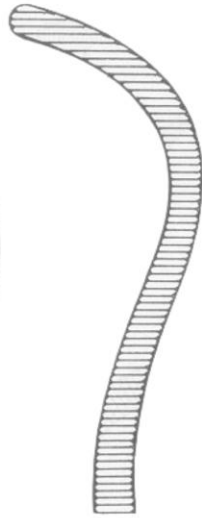

25-6001-22
22 cm/8¾"

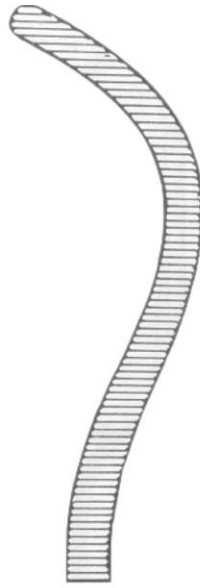

25-6001-24
24 cm/9½"

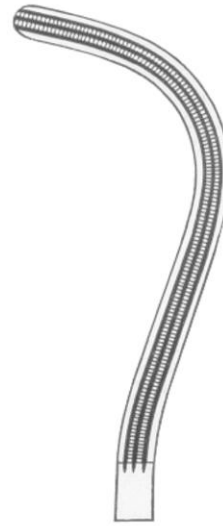

25-6002-23
23 cm/9"



25-6002-24
24 cm/9½"

Atrauma

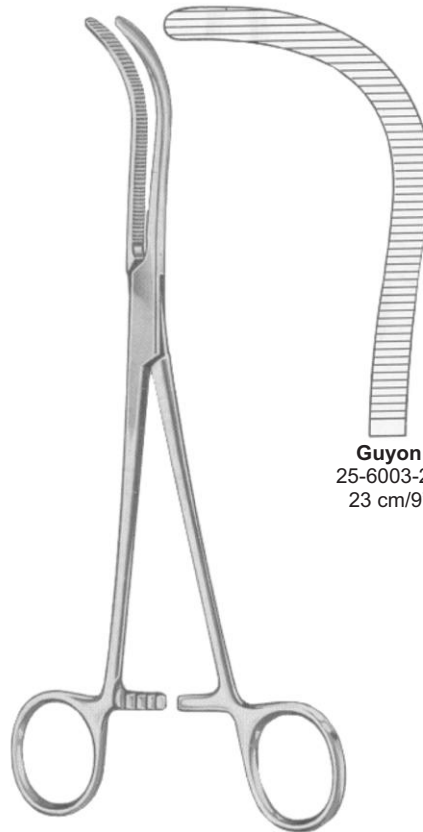

Guyon
25-6003-23
23 cm/9"

KIDNEY, UROLOGY INSTRUMENTS

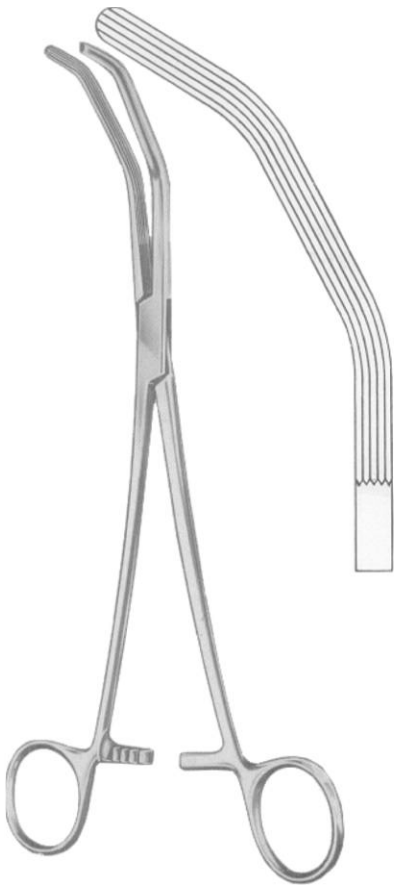

Herrick
25-6004-23
23 cm/9"

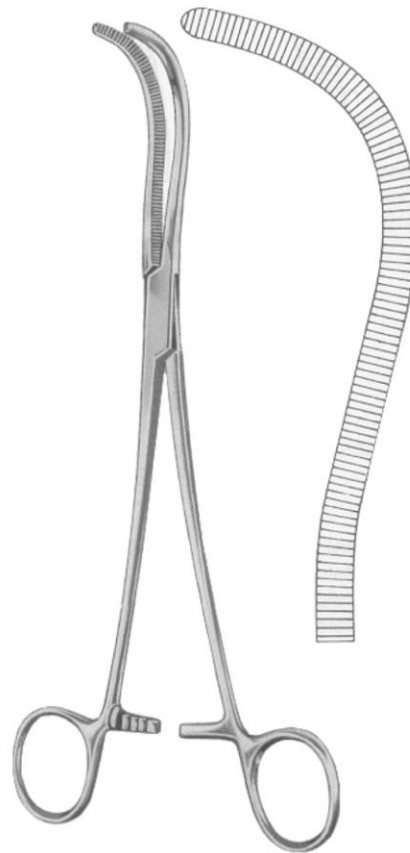

Mayo-Guyon
25-6005-23
23 cm/9"



Stille
25-6006-23
23 cm/9"

KIDNEY, UROLOGY INSTRUMENTS

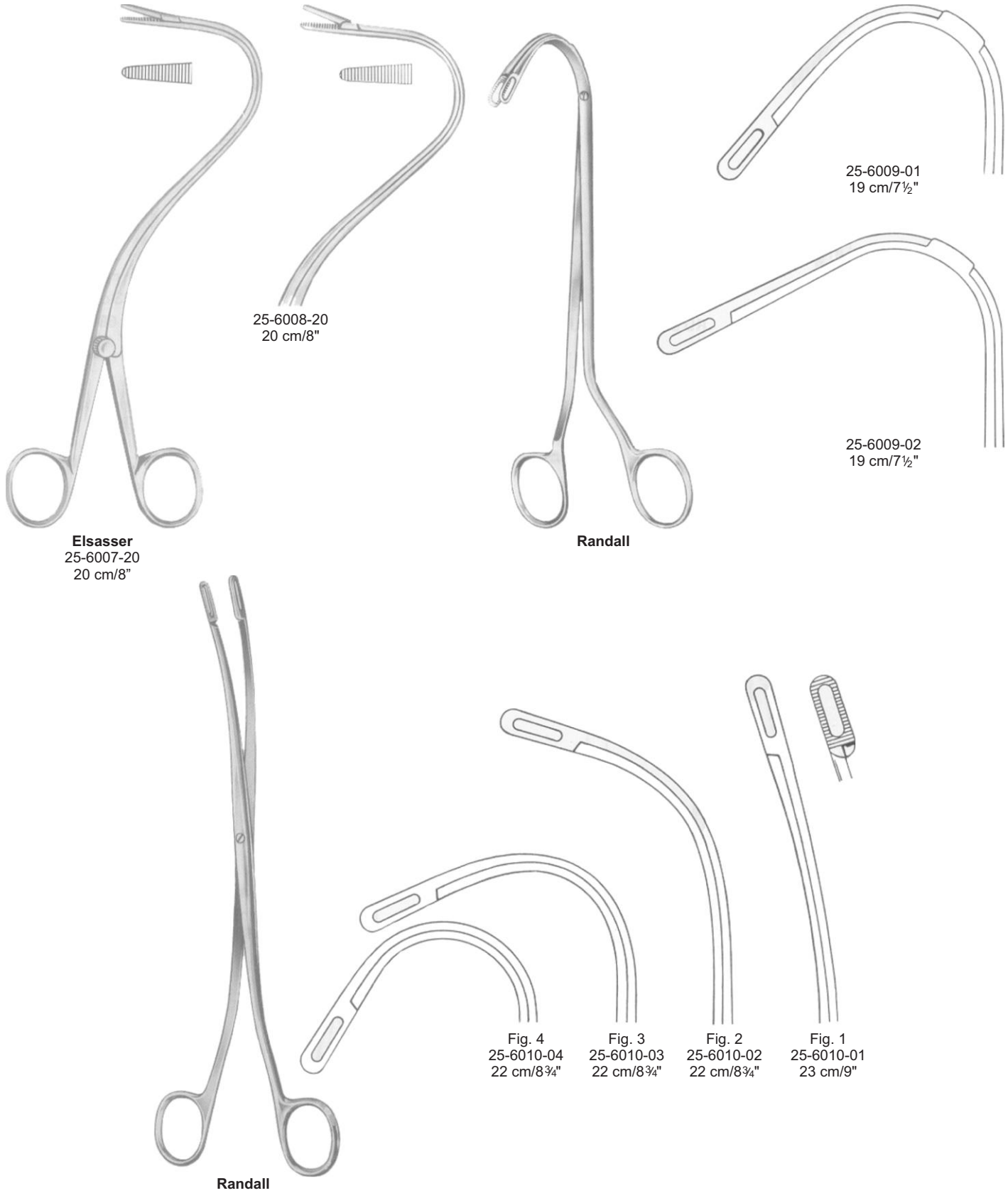

KIDNEY, UROLOGY INSTRUMENTS



Gray
25-6011-00

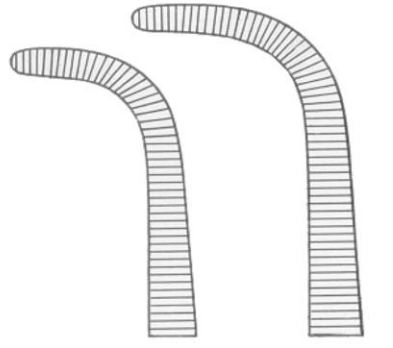

Fig. 1
25-6011-01
22 cm/8 3/4"
 Fig. 2
25-6011-02
23 cm/9"

Set of 2 pieces



Gray
25-6012-00

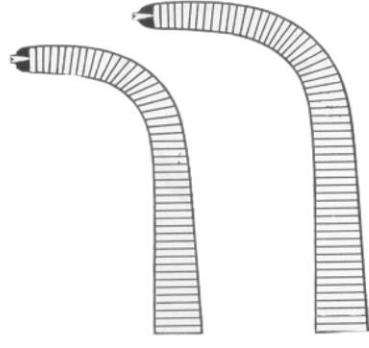

Fig. 1
25-6012-01
22 cm/8 3/4"
 Fig. 2
25-6012-02
23 cm/9"

Set of 2 pieces



Gall duct and
cystic forceps

Desjardins
25-6013-21
21 cm/8 1/4"

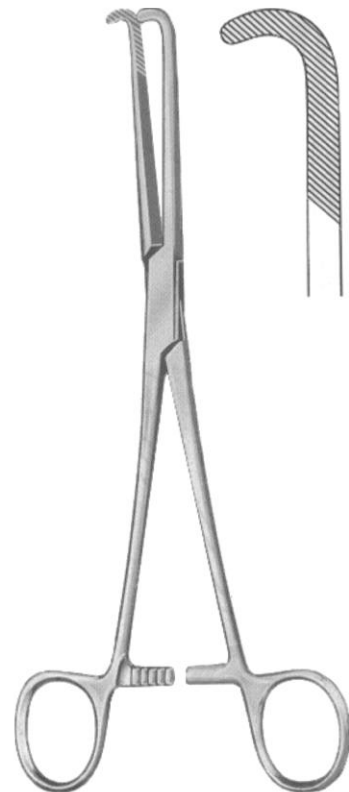

Nissen
25-6014-21
21.5 cm/8 1/2"

KIDNEY, UROLOGY INSTRUMENTS



Straight **Blake** Curved
25-6015-20 20 cm/8" 25-6016-20



Straight **Mayo-Blake** Curved
25-6017-20 20 cm/8" 25-6018-20



Czerny
25-6019-24
24.5 cm/9¾"

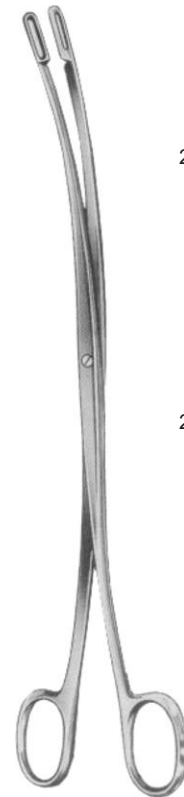

Desjardins
23 cm/9"



Fig. 1
25-6020-01



Fig. 2
25-6021-02

KIDNEY, UROLOGY INSTRUMENTS

Elastic



25-6022-01



25-6023-02



25-6024-03



Desjardins
28 cm/11"

Bile duct dilators.



Bakes
30 cm/12"

mm	
1	25-6025-01
2	25-6025-02
3	25-6025-03
4	25-6025-04
5	25-6025-05
6	25-6025-06
7	25-6025-07
8	25-6025-08
9	25-6025-09
10	25-6025-10
11	25-6025-11
12	25-6025-12
13	25-6025-13

25-6025-00
set of 9 pieces

25-6025-03 to 25-6025-11

25-6026-00
set of 9 pieces in canvas pocket

KIDNEY, UROLOGY INSTRUMENTS

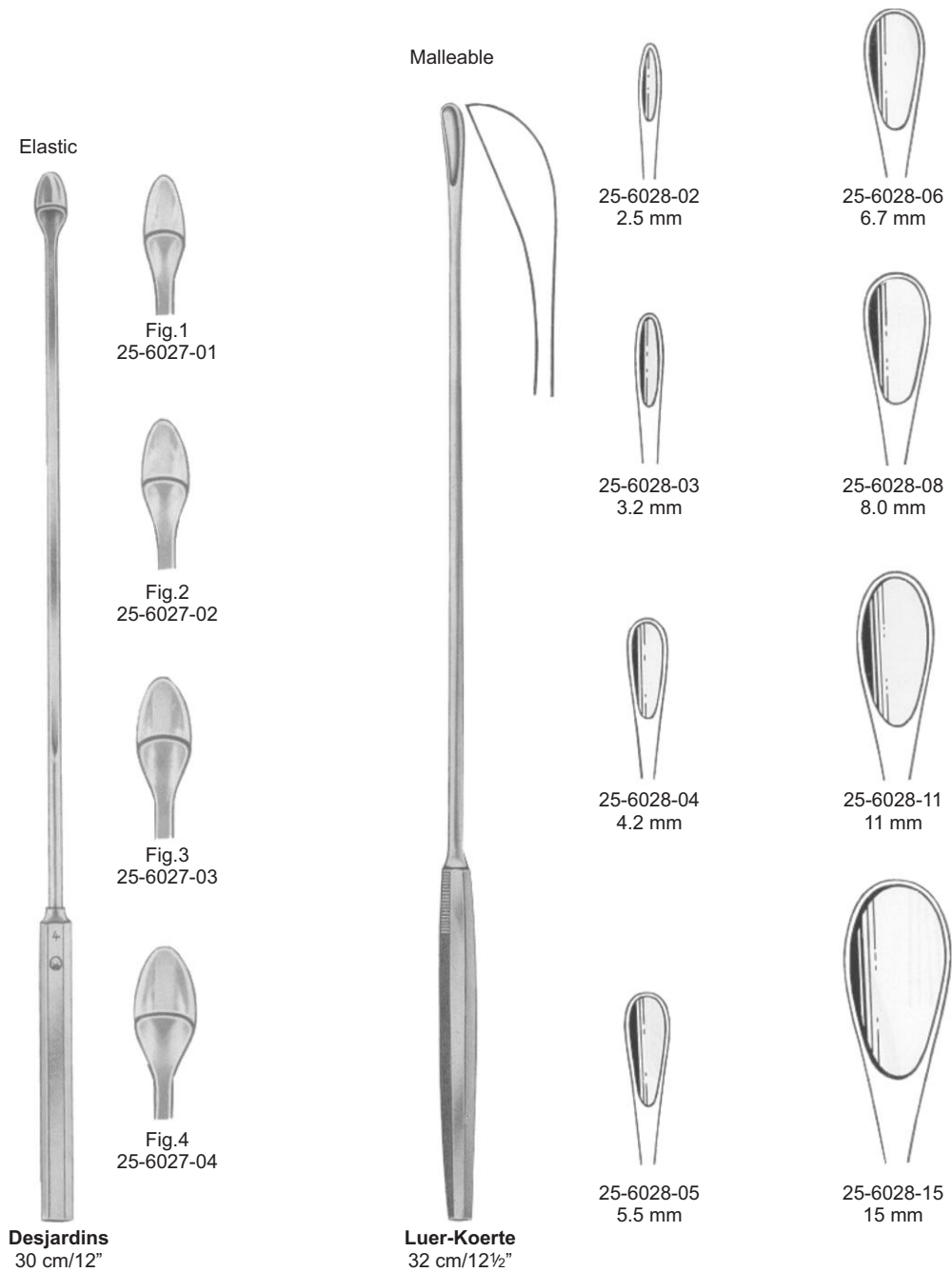

KIDNEY, UROLOGY INSTRUMENTS

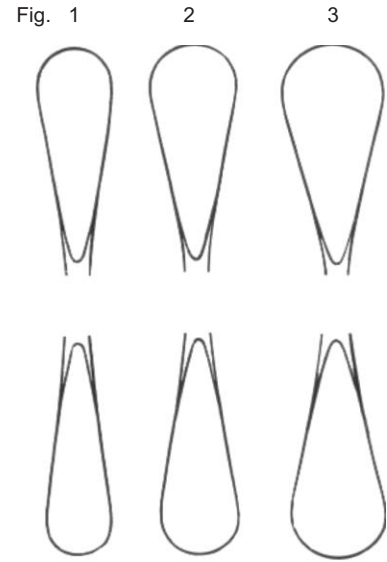
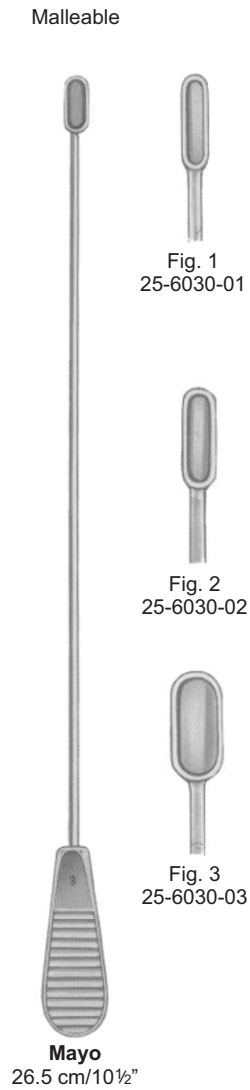

Fig.
 1 25-6031-01
 2 25-6031-02
 3 25-6031-03



KIDNEY, UROLOGY INSTRUMENTS



Young
 25-6032-21
 21 cm/8 1/4"



Young
 25-6033-22
 22 cm/8 3/4"



Young
 25-6034-21
 21 cm/8 1/4"



Young
 25-6035-22
 22 cm/8 3/4"



Millin
 25-6036-23
 23 cm/9"



Millin
 25-6037-23
 23 cm/9"

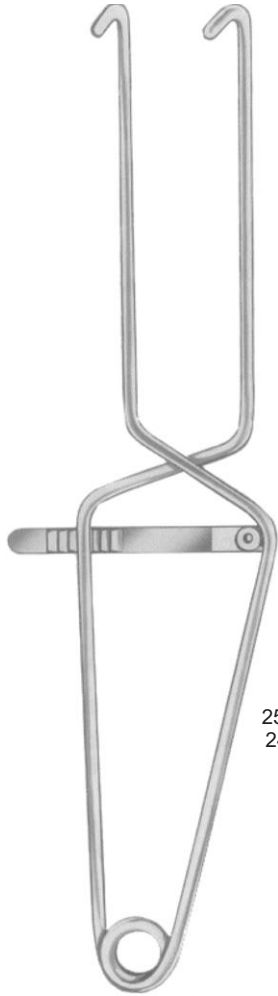

Millin
 25-6038-23
 23 cm/9"

KIDNEY, UROLOGY INSTRUMENTS

Millin
25-6039-24
24 cm/9½"

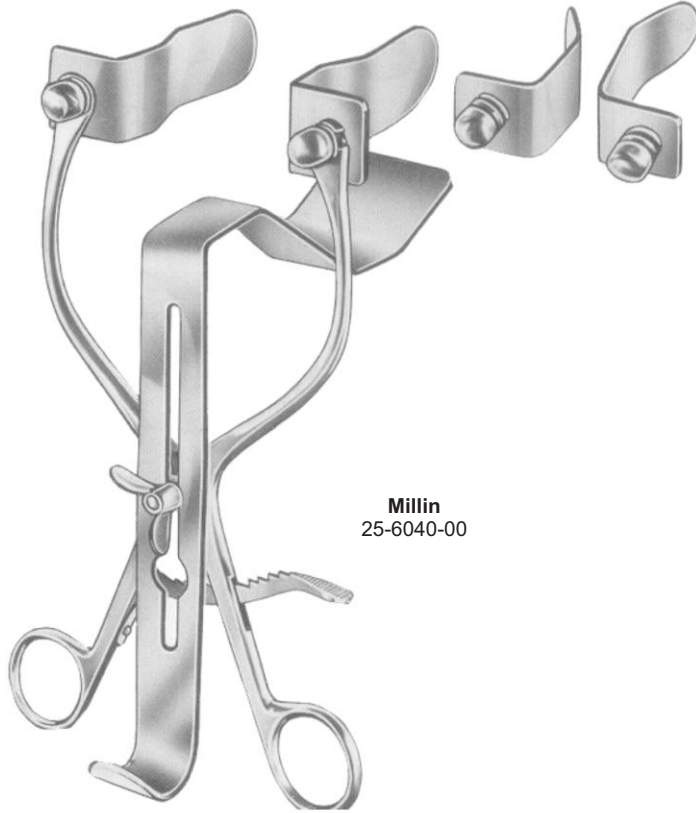

Millin
25-6040-00



Legueu
25-6041-00

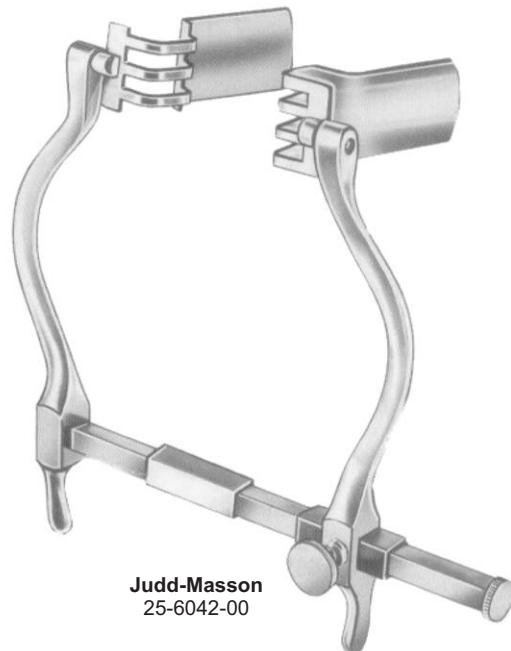

Judd-Masson
25-6042-00

KIDNEY, UROLOGY INSTRUMENTS

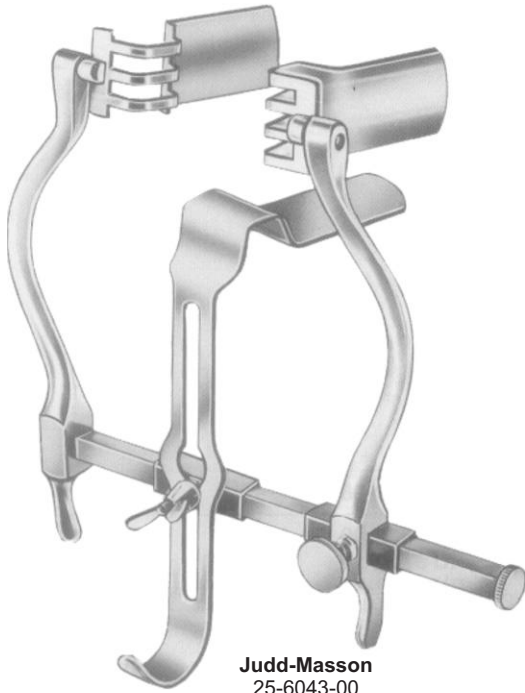

Judd-Masson
25-6043-00



Thomson-Walker
25-6044-00



Legueu
25-6045-27
27 cm/10½"
35 mm



Kocher
25-6046-26
26 cm/10¼"
67 mm

KIDNEY, UROLOGY INSTRUMENTS

 mm Ø Charriere
(French)

2 ² / ₃	8
3	9
3 ¹ / ₃	10
3 ² / ₃	11
4	12
4 ¹ / ₃	13
4 ² / ₃	14
5	15
5 ¹ / ₃	16
5 ² / ₃	17
6	18
6 ¹ / ₃	19
6 ² / ₃	20
7	21
7 ¹ / ₃	22
7 ² / ₃	23
8	24
8 ¹ / ₃	25
8 ² / ₃	26
9	27
9 ¹ / ₃	28
9 ² / ₃	29
10	30
10 ¹ / ₃	32
11 ² / ₃	34
12	36



Van Buren
 Charriere (French)
 No. 8-36
 25-6047-08
 25-6047-36
 28 cm/11"
 In Canvas Pouch
 25-6047-50
 Set of 6
 6 Pcs. 25-6047-14/24
 25-6047-24
 25-6047-60
 Set of 12
 12 Pcs 25-6047-08/36
 25-6047-36

25-6047-08
25-6047-10
25-6047-12
25-6047-14
25-6047-16
25-6047-18
25-6047-20
25-6047-22
25-6047-24
25-6047-26
25-6047-28
25-6047-30
25-6047-32
25-6047-34
25-6047-36



Dittel
 Charriere (French)
 No. 8-30
 25-6048-08
 25-6048-30
 19.5 cm/7 1/2"

Straight

25-6048-08
25-6048-09
25-6048-10
25-6048-11
25-6048-12
25-6048-13
25-6048-14
25-6048-15
25-6048-16
25-6048-17
25-6048-18
25-6048-19
25-6048-20
25-6048-21
25-6048-22
25-6048-23
25-6048-24
25-6048-25
25-6048-26
25-6048-27
25-6048-28
25-6048-26
25-6048-30

Curved

25-6049-08
25-6049-09
25-6049-10
25-6049-11
25-6049-12
25-6049-13
25-6049-14
25-6049-15
25-6049-16
25-6049-17
25-6049-18
25-6049-19
25-6049-20
25-6049-21
25-6049-22
25-6049-23
25-6049-24
25-6049-25
25-6049-26
25-6049-27
25-6049-28
25-6049-26
25-6049-30



Dittel
 Charriere (French)
 No. 8-30
 25-6049-08
 25-6049-30
 34.5 cm/13 1/2"

KIDNEY, UROLOGY INSTRUMENTS

For men



25-6050-06
 25-6050-24

	mm Ø	Charriere (French)	
25-6050-06	2	6	25-6051-06
25-6050-07	2 $\frac{1}{3}$	7	25-6051-07
25-6050-08	2 $\frac{2}{3}$	8	25-6051-08
25-6050-09	3	9	25-6051-09
25-6050-10	3 $\frac{1}{3}$	10	25-6051-10
25-6050-11	3 $\frac{2}{3}$	11	25-6051-11
25-6050-12	4	12	25-6051-12
25-6050-13	4 $\frac{1}{3}$	13	25-6051-13
25-6050-14	4 $\frac{2}{3}$	14	25-6051-14
25-6050-15	5	15	25-6051-15
25-6050-16	5 $\frac{1}{3}$	16	25-6051-16
25-6050-17	5 $\frac{2}{3}$	17	25-6051-17
25-6050-18	6	18	25-6051-18
25-6050-19	6 $\frac{1}{3}$	19	25-6051-19
25-6050-20	6 $\frac{2}{3}$	20	25-6051-20
25-6050-21	7	21	25-6051-21
25-6050-22	7 $\frac{1}{3}$	22	25-6051-22
25-6050-23	7 $\frac{2}{3}$	23	25-6051-23
25-6050-24	8	24	25-6051-24

For Women



Catheter Introducing Instruments



Guyon
 25-6052-39
 39 cm/15 $\frac{1}{2}$ "

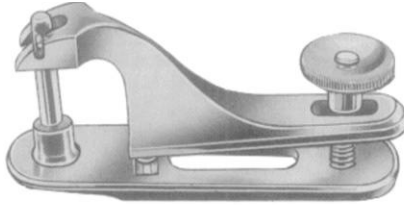

Guyon
 25-6053-35
 35 cm/13 $\frac{3}{4}$ "

KIDNEY, UROLOGY INSTRUMENTS
Circumcision Instruments

25-6054-08	08 mm
25-6054-11	11 mm
25-6054-13	13 mm
25-6054-16	16 mm
25-6054-21	21 mm
25-6054-26	26 mm
25-6054-32	32 mm

Foreign Body Forceps

Mathieu
 25-6055-20

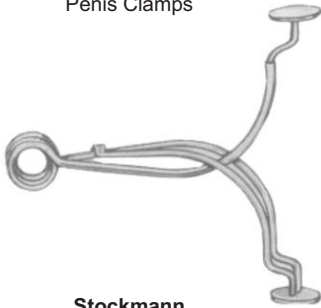
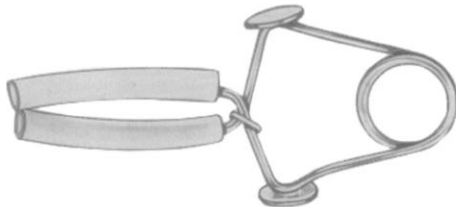
Penis Clamps

Stockmann
 25-6056-00

Strauss
 25-6057-00

Secretion Scoop

Guttman
 25-6058-26
 26.5 cm/10½"

EN Gynecology

DE Gynäkologie

ES Ginecología

Page 519 to 558



GYNECOLOGY

Scheme of Dimensions for Specula

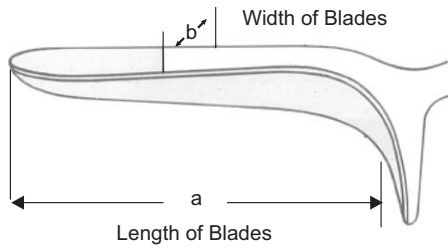

	a mm	b mm
26-6101-01	75	32
26-6101-02	85	35
26-6101-03	100	37

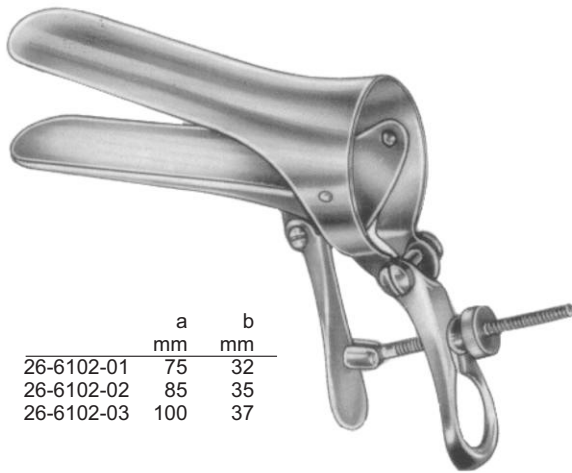
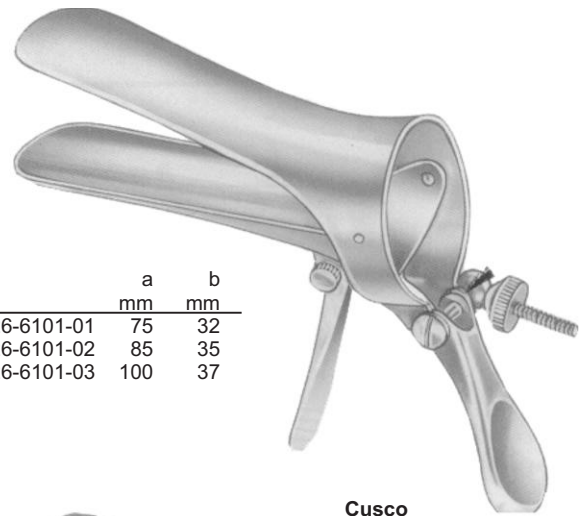

Cusco

For Virgins	a mm	b mm
26-6103-00	75	17

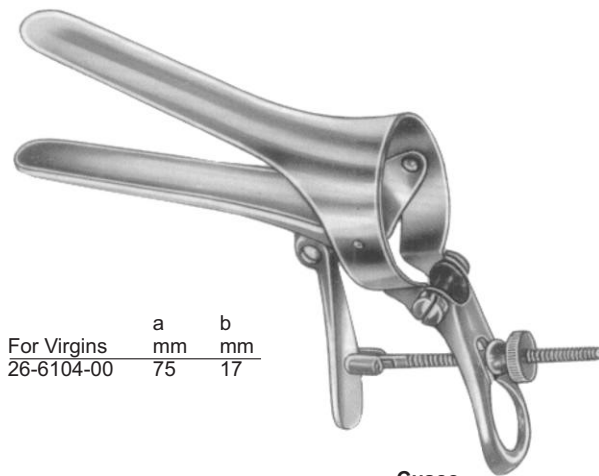

Cusco

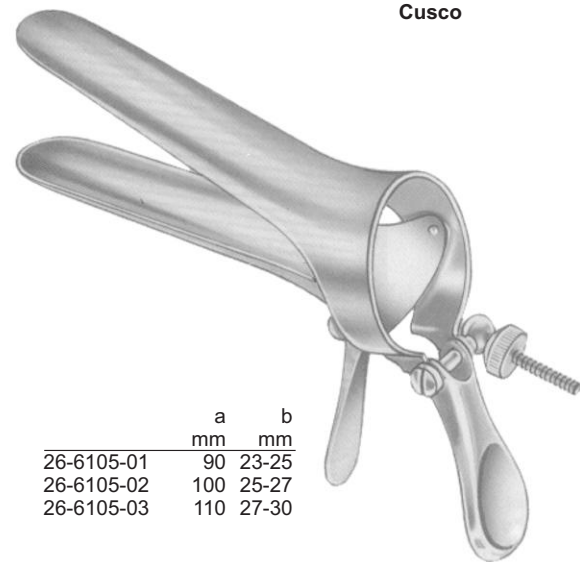

Cusco
Swiss Pattern

GYNECOLOGY

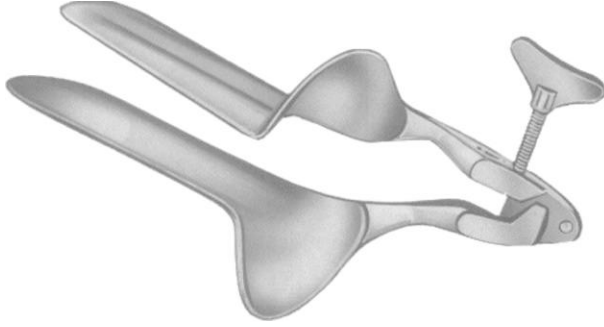
**Collin-Landau**

Small	26-6106-01	30 x 85 mm
Medium	26-6106-02	35 x 100 mm
Large	26-6106-03	40 x 110 mm

**Collin**

Small	26-6107-01	30 x 85 mm
Medium	26-6107-02	35 x 100 mm
Large	26-6107-03	40 x 110 mm

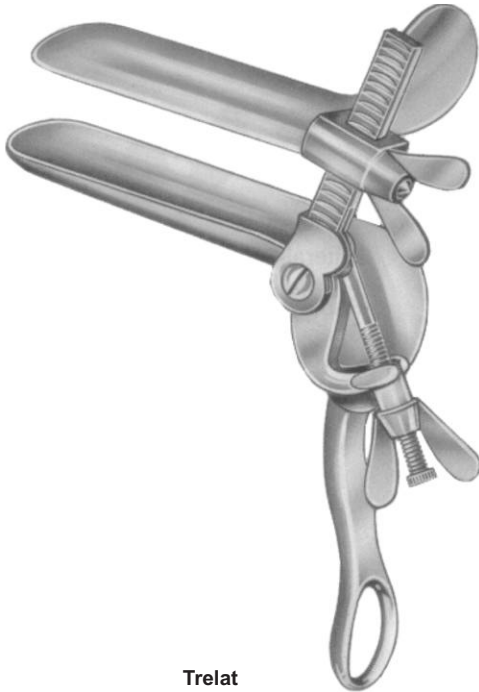
**Trelat**

	a mm	b mm
26-6108-01	85	33
26-6108-02	95	35
26-6108-03	115	43

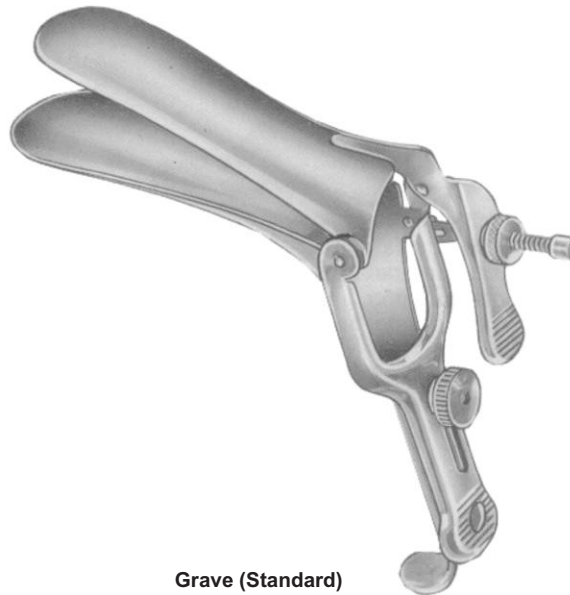
**Grave (Standard)**

	a mm	b mm
26-6109-01	75	20
26-6109-02	95	30
26-6109-03	115	35
26-6109-04	125	35

GYNECOLOGY

Black



Grave	a mm	b mm
26-6110-01	75	20
26-6110-02	95	35
26-6110-03	115	35



Grave Angled 135°	a mm	b mm
26-6111-00	101	35

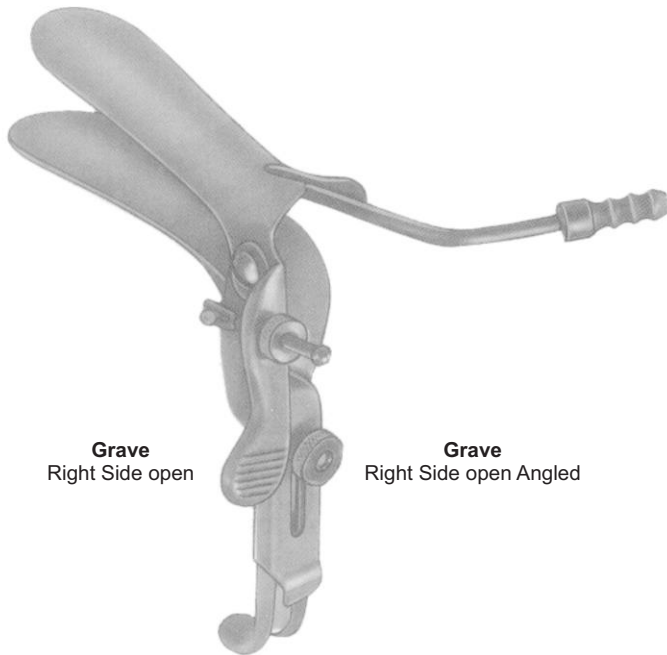

Grave
Right Side open

26-6112-01

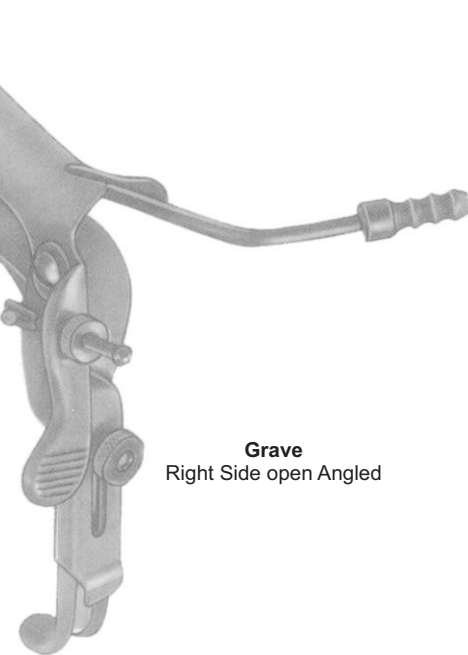

Grave
Right Side open Angled

26-6112-02

a mm	b mm
101	35

Lateral Specula

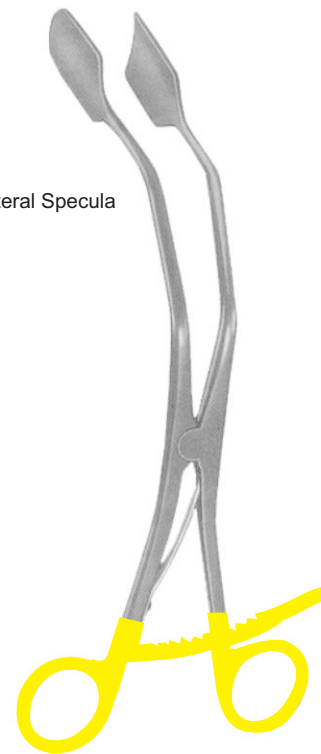

26-6113-00

GYNECOLOGY



Pederson

	a mm	b mm
26-6114-01	75	13
26-6114-02	100	22
26-6114-03	120	25

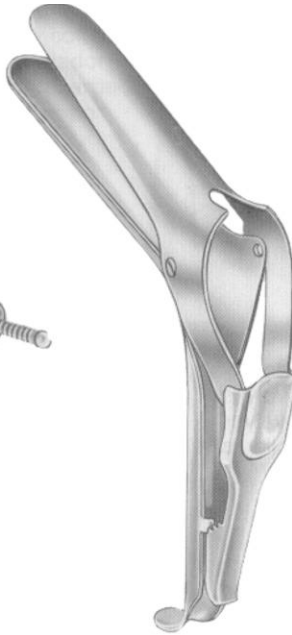

Semm

	a mm	b mm
26-6115-01	90	14/18
26-6115-02	100	17/20
26-6115-03	100	25/30

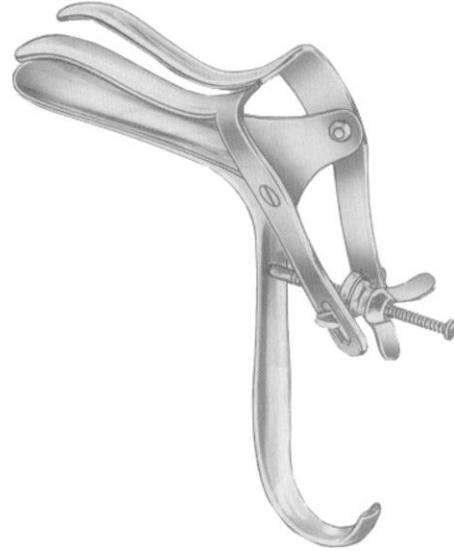

Nott

	a mm	b mm
26-6116-01	90	30
26-6116-02	110	30

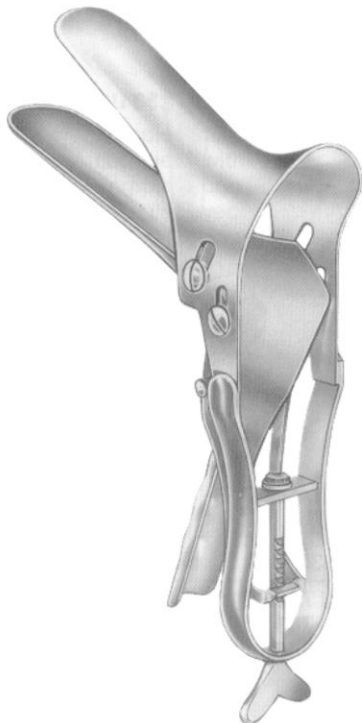

Seyffert

	a mm	b mm
26-6117-01	100	17
26-6117-02	110	33

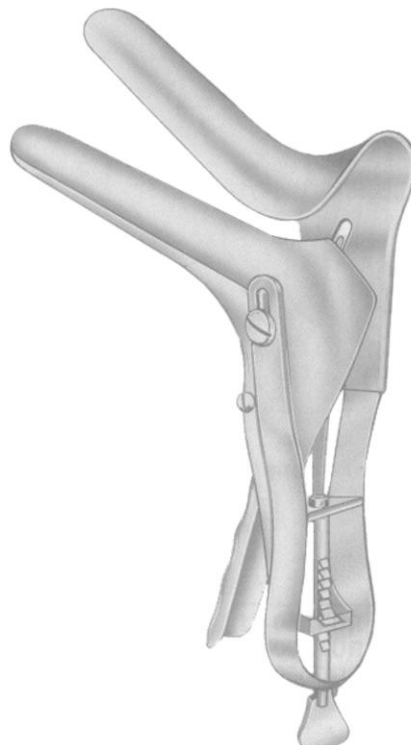

One Side open

Seyffert

	a mm	b mm
26-6118-02	110	33

GYNECOLOGY

Scheme of Dimensions for Specula

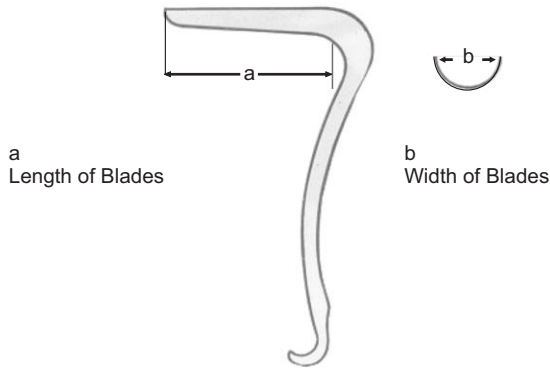

Sims (single ended)
26-6119-01 63 x 32 mm
26-6119-02 76 x 32 mm
26-6119-03 89 x 38 mm

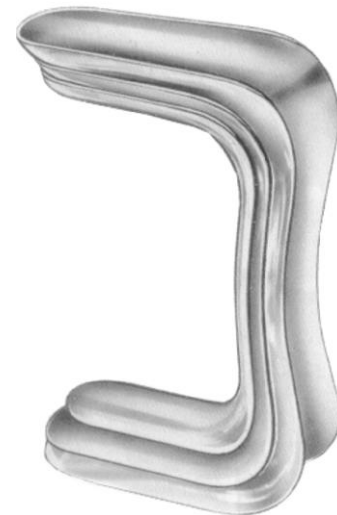

Sims (double ended)
26-6120-01 26 x 70 mm (30 x 75 mm)
26-6120-02 30 x 75 mm (35 x 80 mm)
26-6120-03 36 x 80 mm (40 x 90 mm)



Jackson

	Fig.	a mm	b mm
26-6121-01	1	75 X 40	
26-6121-02	2	90 X 40	
26-6121-03	3	100 X 40	



Eastman

	Fig.	a mm	b mm
26-6122-01	1	76	38
26-6122-02	2	89	38
26-6122-03	3	101	38

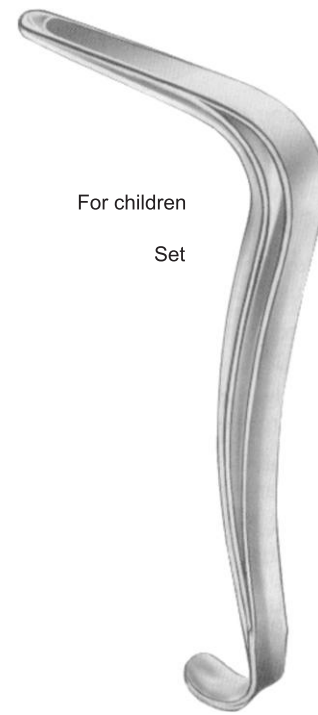

Kristeller
26-6123-00
70x15 mm

GYNECOLOGY

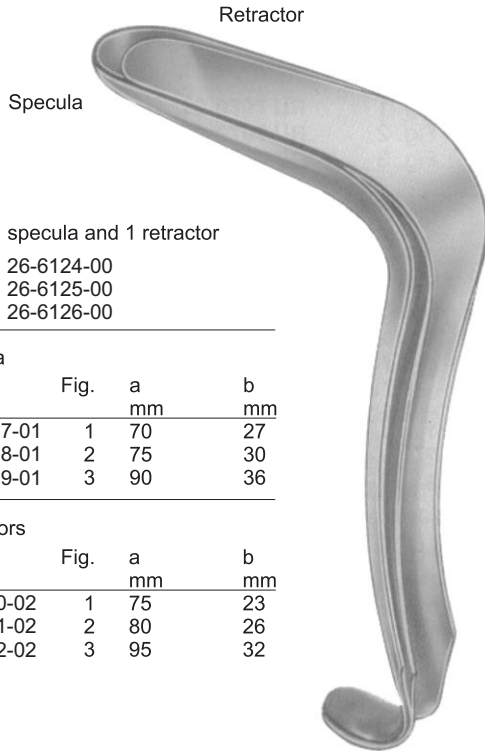

Set of 1 specula and 1 retractor

- Fig. 1 26-6124-00
- Fig. 2 26-6125-00
- Fig. 3 26-6126-00

Specula

	Fig.	a	b
		mm	mm
26-6127-01	1	70	27
26-6128-01	2	75	30
26-6129-01	3	90	36

Retractors

	Fig.	a	b
		mm	mm
26-6130-02	1	75	23
26-6131-02	2	80	26
26-6132-02	3	95	32

**Kristeller
(Standard)**

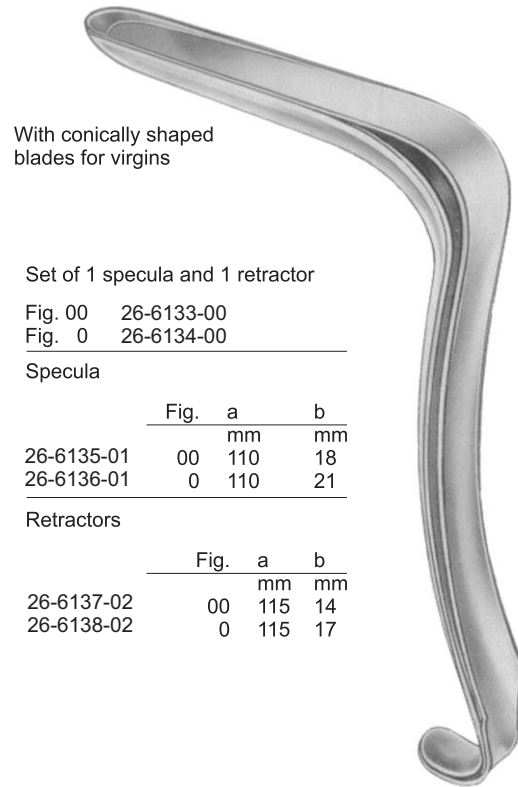

With conically shaped blades for virgins

Set of 1 specula and 1 retractor

- Fig. 00 26-6133-00
- Fig. 0 26-6134-00

Specula

	Fig.	a	b
		mm	mm
26-6135-01	00	110	18
26-6136-01	0	110	21

Retractors

	Fig.	a	b
		mm	mm
26-6137-02	00	115	14
26-6138-02	0	115	17

Kristeller

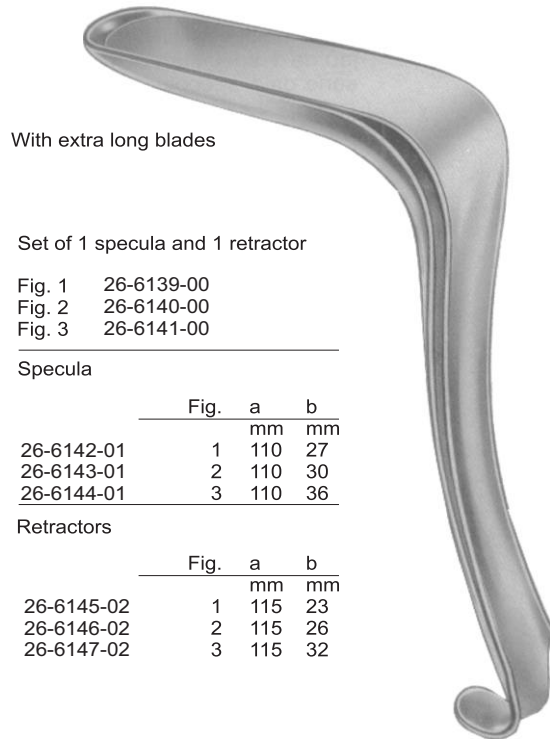

With extra long blades

Set of 1 specula and 1 retractor

- Fig. 1 26-6139-00
- Fig. 2 26-6140-00
- Fig. 3 26-6141-00

Specula

	Fig.	a	b
		mm	mm
26-6142-01	1	110	27
26-6143-01	2	110	30
26-6144-01	3	110	36

Retractors

	Fig.	a	b
		mm	mm
26-6145-02	1	115	23
26-6146-02	2	115	26
26-6147-02	3	115	32

**Kristeller
(Standard)**

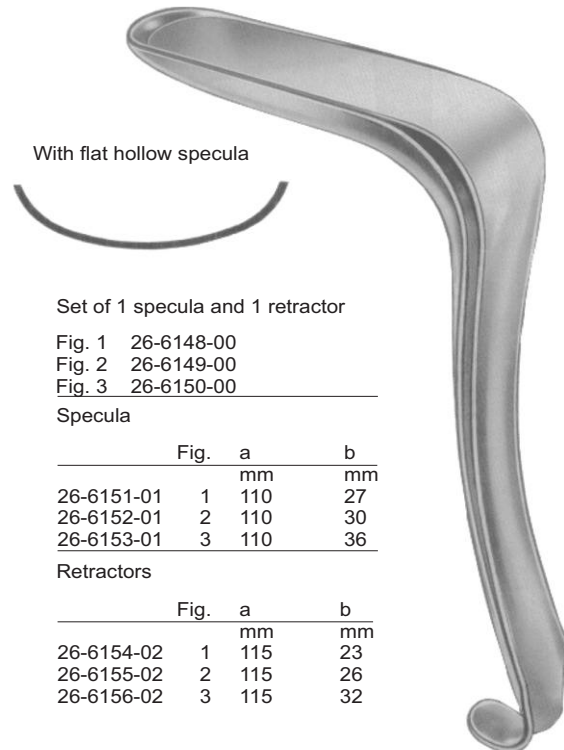

With flat hollow specula

Set of 1 specula and 1 retractor

- Fig. 1 26-6148-00
- Fig. 2 26-6149-00
- Fig. 3 26-6150-00

Specula

	Fig.	a	b
		mm	mm
26-6151-01	1	110	27
26-6152-01	2	110	30
26-6153-01	3	110	36

Retractors

	Fig.	a	b
		mm	mm
26-6154-02	1	115	23
26-6155-02	2	115	26
26-6156-02	3	115	32

Kristeller

GYNECOLOGY

	a mm	b mm
26-6157-20	100	20
26-6157-25	100	25
26-6157-30	100	30
26-6157-35	100	35
26-6157-40	100	40
26-6158-20	130	20
26-6158-25	130	25
26-6158-30	130	30
26-6158-35	130	35
26-6158-40	130	40

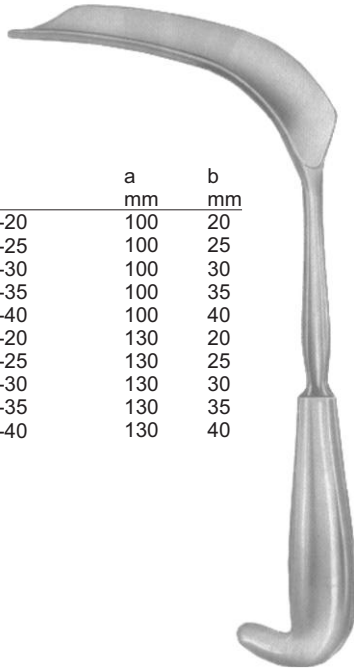

Matzenauer



Braun
26-6159-18
18 cm/7"
56x13 mm



Braun
26-6160-18
18 cm/7"
60x10 mm



Ulrich
26-6161-19
19.5 cm/7½"
80x20 mm



26-6162-19
19 cm/7½"
85x17 mm

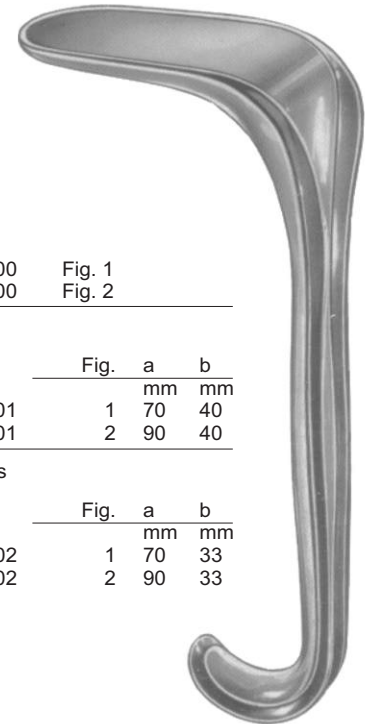

Set

26-6163-00 Fig. 1
26-6164-00 Fig. 2

Specula

	Fig.	a	b
		mm	mm
26-6165-01	1	70	40
26-6166-01	2	90	40

Retractors

	Fig.	a	b
		mm	mm
26-6167-02	1	70	33
26-6168-02	2	90	33

GYNECOLOGY

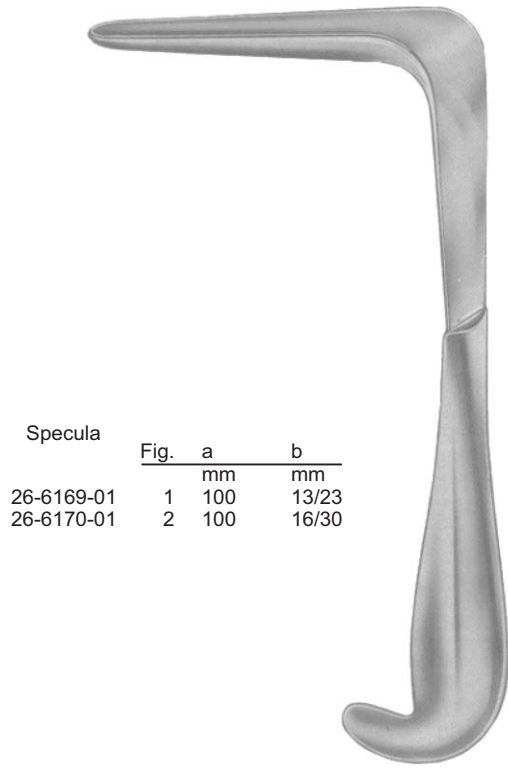

Specula	Fig.	a	b
		mm	mm
26-6169-01	1	100	13/23
26-6170-01	2	100	16/30

Mathieu

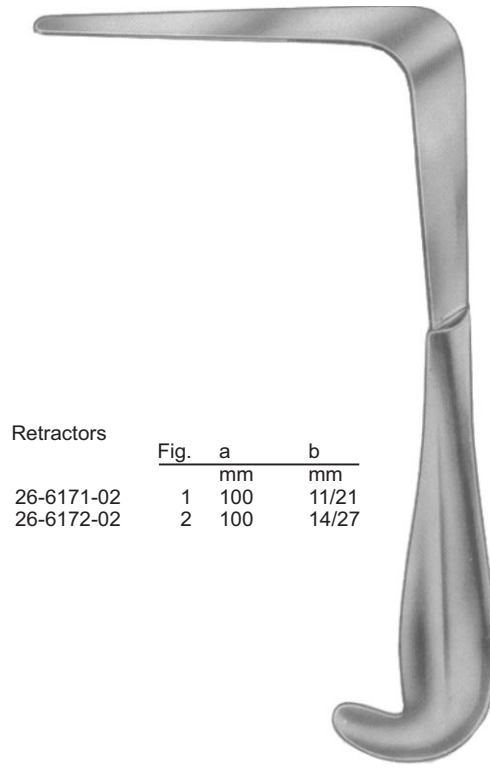

Retractors	Fig.	a	b
		mm	mm
26-6171-02	1	100	11/21
26-6172-02	2	100	14/27

Mathieu

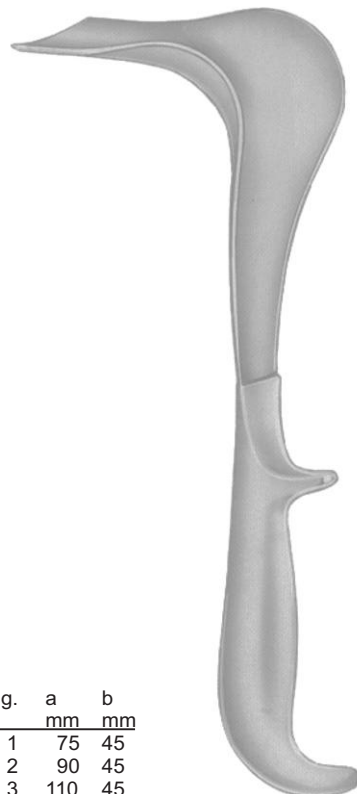

	Fig.	a	b
		mm	mm
26-6173-01	1	75	45
26-6173-02	2	90	45
26-6173-03	3	110	45

Doyen



26-6174-01	75 x 280mm
26-6174-02	90 x 280mm
26-6174-03	100 x 280mm
26-6174-03	115 x 280mm

Doyen

Hollow handle 28cm/11"

GYNECOLOGY



Doyen 24 cm/9½"				Doyen 24 cm/9½"			
	Fig.	a mm	b mm				
slightly-concave				Medium-concave			
26-6175-01	1	55	35	26-6178-01			
26-6175-02	2	85	35	26-6178-02			
26-6175-03	3	115	35	26-6178-03			
26-6176-01	1	55	45	26-6179-01			
26-6176-02	2	85	45	26-6179-02			
26-6176-03	3	115	45	26-6179-03			
26-6176-04	4	160	45				
26-6176-05	5	180	45				
26-6177-01	1	55	60	26-6180-01			
26-6177-02	2	85	60	26-6180-02			
26-6177-03	3	115	60	26-6180-03			
26-6177-04	4	160	60				
26-6177-05	5	180	60				

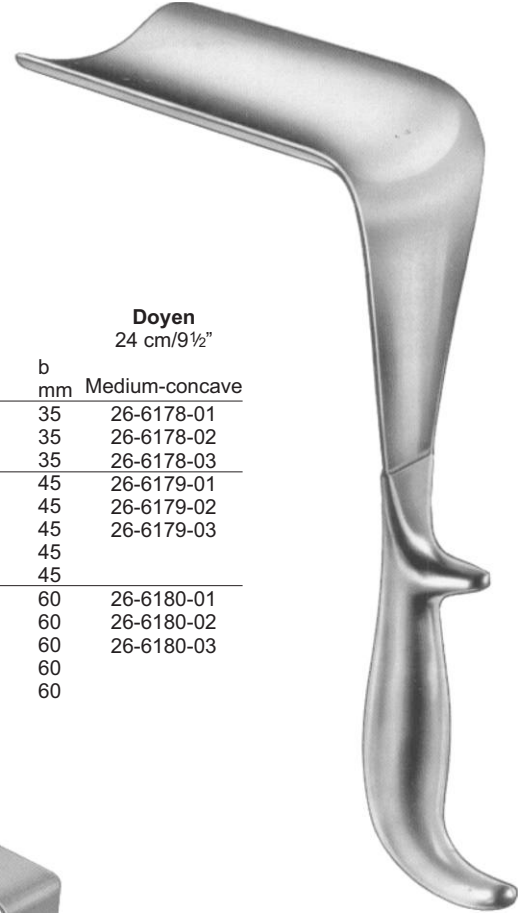

Doyen
25 cm/10"

	a mm	b mm
26-6181-01	60	30
26-6181-02	70	30
26-6181-03	80	30



GYNECOLOGY



Auvard
 with removable weight
 26-6182-01
 80x38 mm
 26-6182-02
 105x42 mm



Auvard
 with fixed weight
 26-6183-01
 70x38 mm
 26-6183-02
 102x45 mm



Landau

	a	b
	mm	mm
26-6184-01	100	28
26-6184-02	100	38



Breisky

	a	b
	mm	mm
26-6185-20	100	20
26-6185-25	100	25
26-6185-30	100	30
26-6185-35	100	35
26-6185-40	100	40
26-6186-20	130	20
26-6186-25	130	25
26-6186-30	130	30
26-6186-35	130	35
26-6186-40	130	40
26-6187-20	160	20
26-6187-25	160	25
26-6187-30	160	30
26-6187-35	160	35
26-6187-40	160	40
26-6188-20	180	20
26-6188-25	180	25
26-6188-30	180	30
26-6188-35	180	35
26-6188-40	180	40

GYNECOLOGY

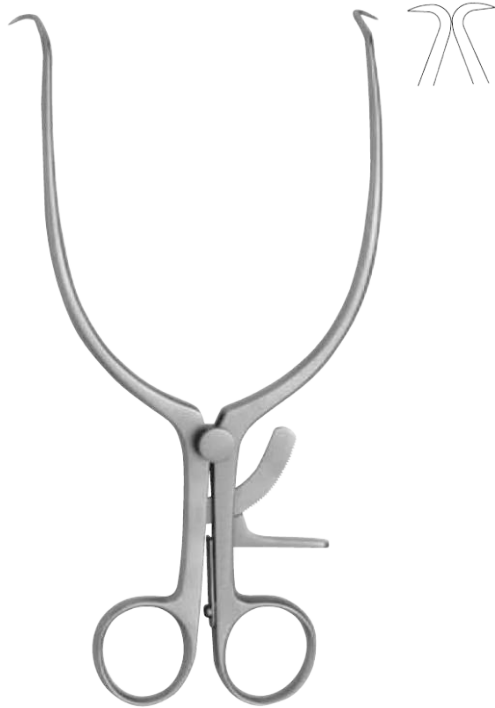

Gelpi
Vulva self retaining
26-6189-20 20cm/8"



Comyn Berkeley
Vulva self retaining
26-6190-15 15.5cm/6"

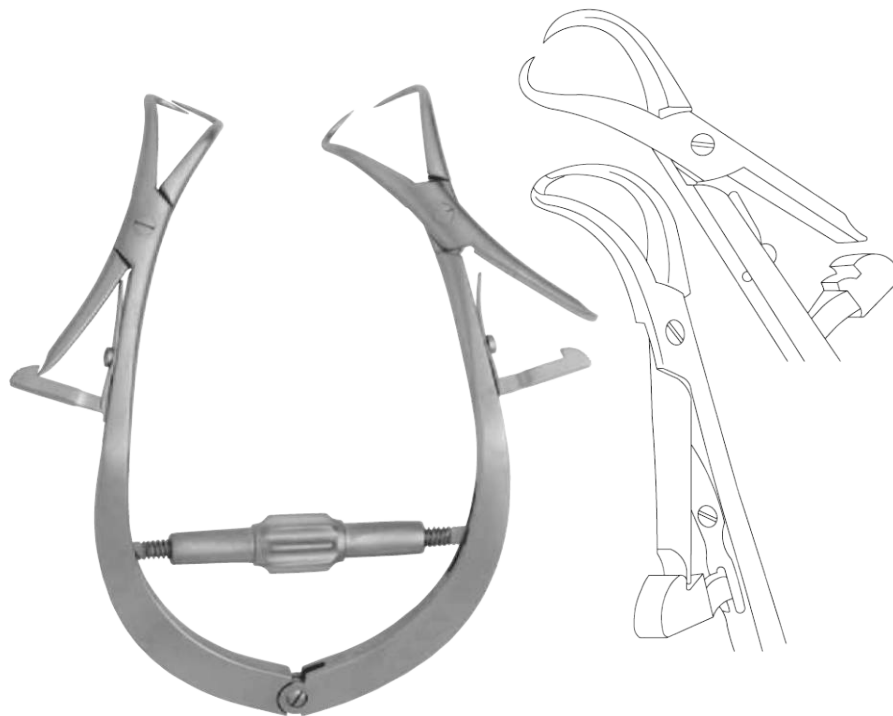

Joll
Thyroid self retaining
26-6191-15 15.5cm/6"

GYNECOLOGY

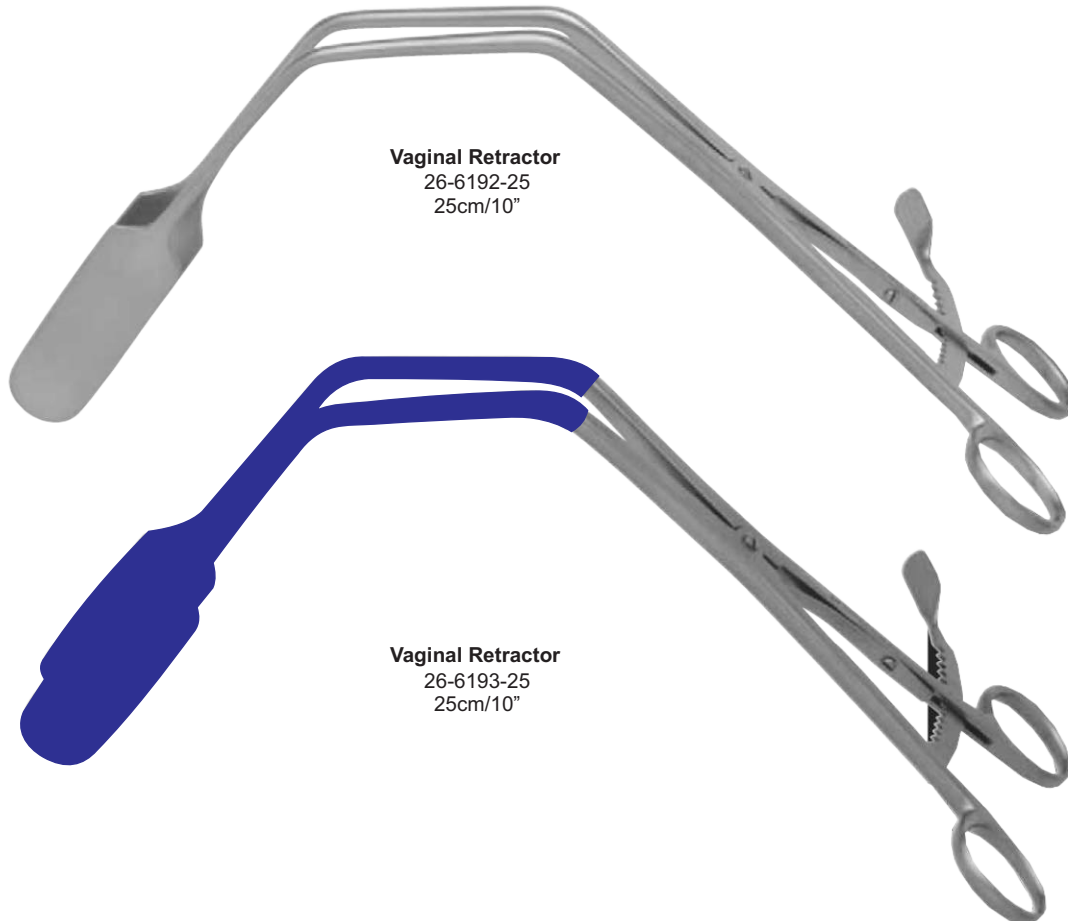
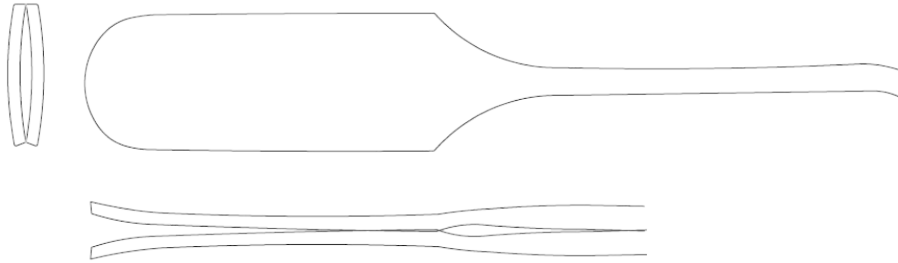

Vaginal Retractor
26-6192-25
25cm/10"

Vaginal Retractor
26-6193-25
25cm/10"

GYNECOLOGY



Scherbak
26-6194-00

Complete



26-6194-01
80x30 mm



26-6194-02
85x35 mm

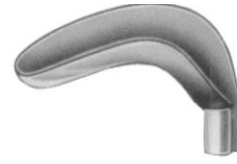

26-6194-03
90x40 mm



26-6194-04
55x40/60 mm



26-6194-05
70x45/70 mm

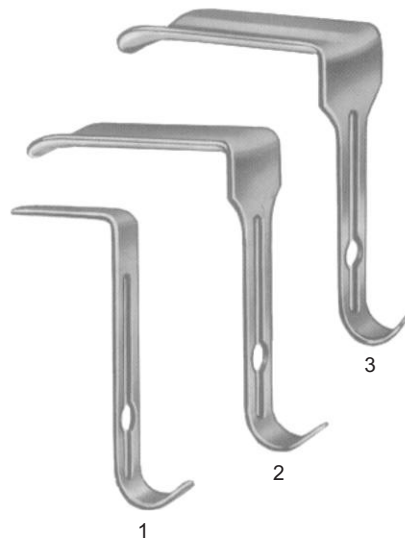
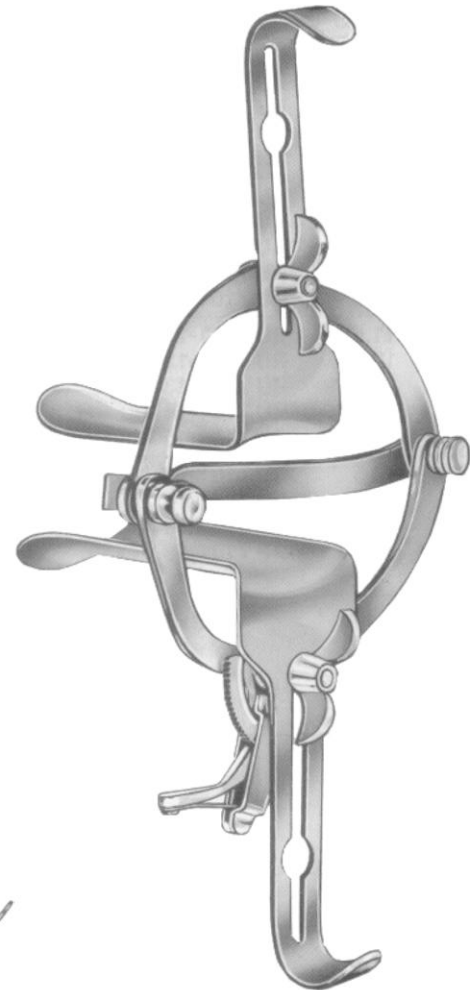

	Fig.	a mm	b mm
26-6195-01	1	45	17
26-6195-02	2	90	37
26-6195-03	3	90	45



O'Sullivan-O'Connor
26-6195-00
Complete

GYNECOLOGY



Hegar
single ended
18.5 cm long

mm Ø	
2.0	26-6196-02
3.0	26-6196-03
4.0	26-6196-04
5.0	26-6196-05
6.0	26-6196-06
7.0	26-6196-07
8.0	26-6196-08
9.0	26-6196-09
10.0	26-6196-10
11.0	26-6196-11
12.0	26-6196-12
13.0	26-6196-13
14.0	26-6196-14
15.0	26-6196-15
16.0	26-6196-16
17.0	26-6196-17
18.0	26-6196-18
19.0	26-6196-19
20.0	26-6196-20
21.0	26-6196-21
22.0	26-6196-22
23.0	26-6196-23
24.0	26-6196-24
25.0	26-6196-25
26.0	26-6196-26

Pieces per set		
26-6197-50	12	3 - 14 mm
26-6198-60	25	2 - 26 mm



Hegar
double ended
20 cm long

Ø mm	
1/2	26-6199-02
3/4	26-6199-04
5/6	26-6199-06
7/8	26-6199-08
9/10	26-6199-10
11/12	26-6199-12
13/14	26-6199-14
15/16	26-6199-16
17/18	26-6199-18
19/20	26-6199-20
21/22	26-6199-22
23/24	26-6199-24
25/26	26-6199-26

Pieces per set		set	
26-6200-00	08	3/4 - 17/18 mm	
26-6200-00	12	1/2 - 23/24 mm	

GYNECOLOGY



mm	
3/6	26-6202-03
4/7	26-6202-04
5/8	26-6202-05
6/9	26-6202-06
7/10	26-6202-07
8/11	26-6202-08
9/12	26-6202-09
10/13	26-6202-10
11/14	26-6202-11
12/15	26-6202-12
13/16	26-6202-13
14/17	26-6202-14
15/18	26-6202-15
16/19	26-6202-16
17/20	26-6202-17
18/21	26-6202-18

Hawkin Ambler
 26-6201-16
 17 cm long
 set of 16 3/6 - 18/21



Hank
 26-6203-30

mm	
9/10	26-6204-10
11/12	26-6204-12
13/14	26-6204-14
15/16	26-6204-16
17/18	26-6204-18
19/20	26-6204-20

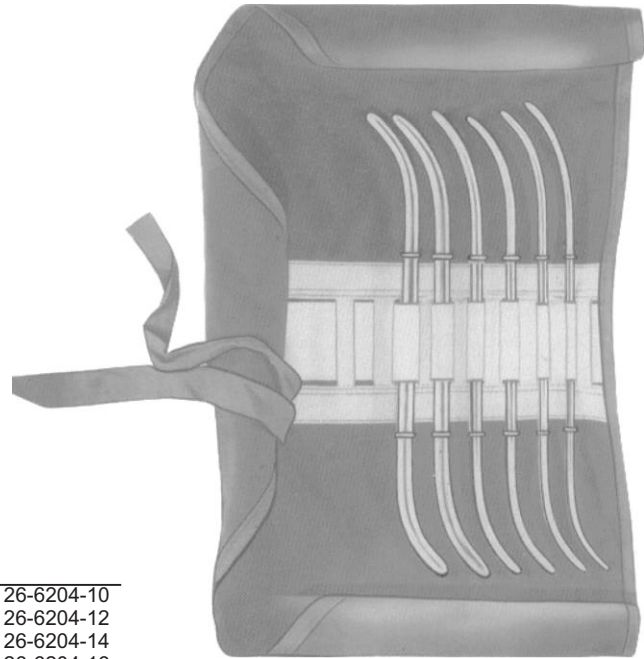

Set
 26-6205-00
 double ended
 27 cm



Pratt

mm	
13/15	26-6206-15
17/19	26-6206-19
21/23	26-6206-23
25/27	26-6206-27
29/31	26-6206-31
33/35	26-6206-35
37/39	26-6206-39
41/43	26-6206-43

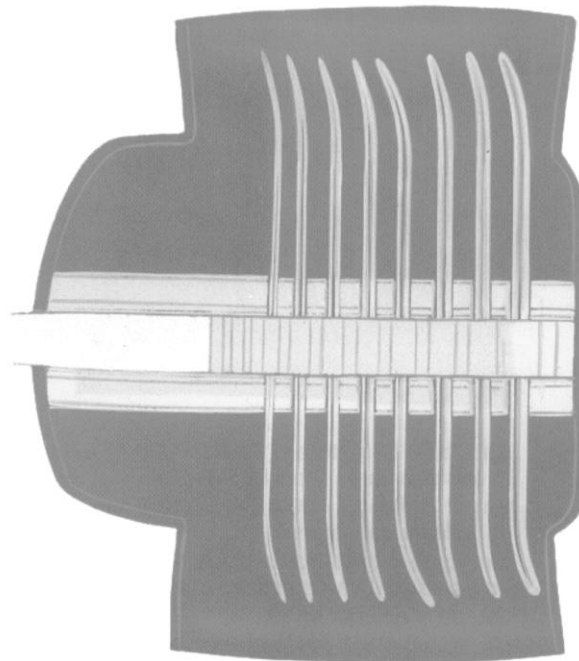

Set
 26-6207-00
 double ended
 29 cm

GYNECOLOGY

Tip 4 mm

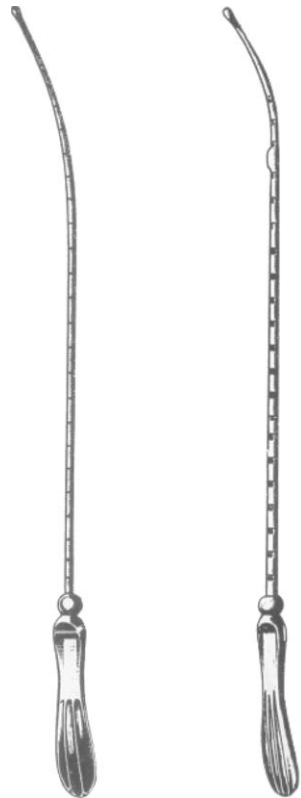

Sims
32 cm/12½"

Martin (Simpson)
32 cm/12½"



Valleix
26-6214-25
25 cm/10"



Collin
26-6215-28
28 cm/11"



Braun
26-6216-28
28 cm/11"

Uterine Depressor

Rigid	cm	cm
	26-6208-32	26-6211-32

Malleable	cm / in	cm / in
	26-6209-32	26-6212-32
	26-6210-32	26-6213-32

GYNECOLOGY

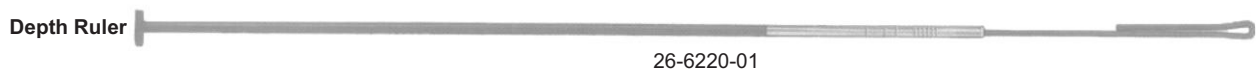
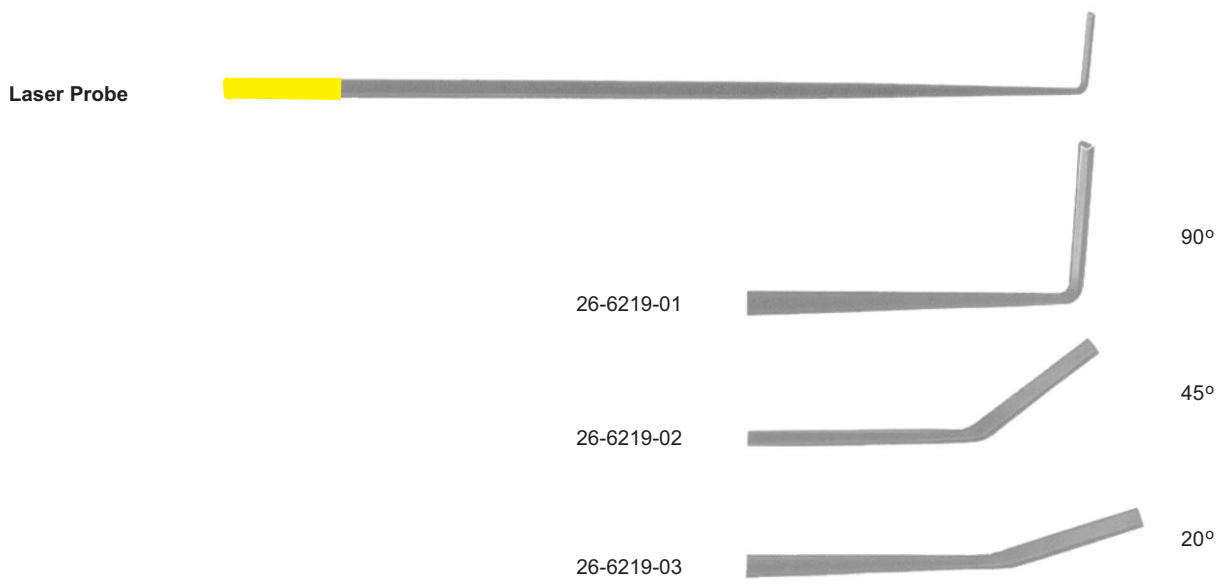
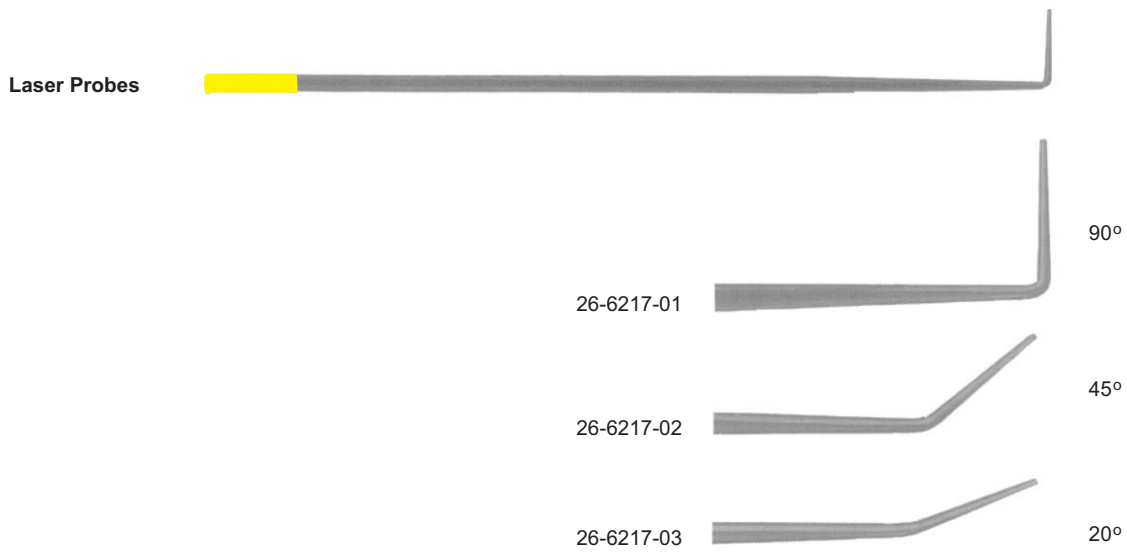

GYNECOLOGY

Measuring Instruments

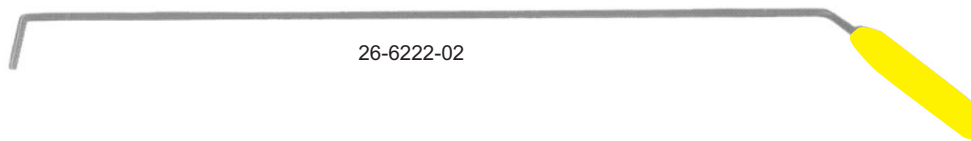
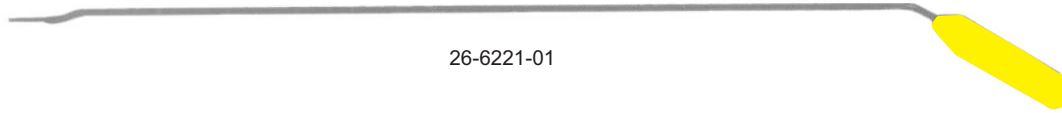

Hooks

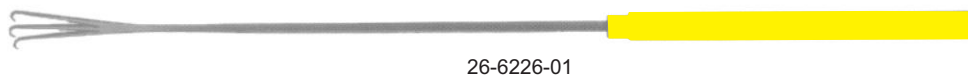
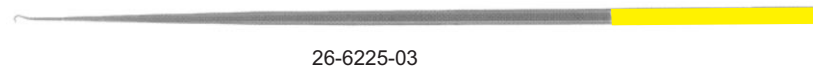
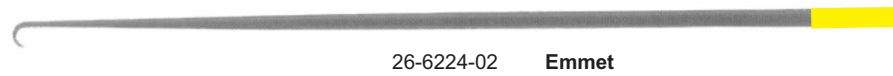
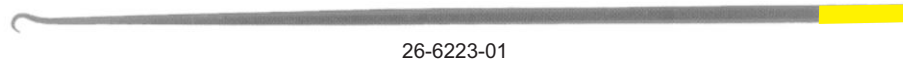

GYNECOLOGY



Ayre
26-6228-23
23 cm/9"



Simon
26-6229-22
22 cm/8¾"



Simon
26-6230-22
22 cm/8¾"



Emmet
22 cm/8¾"



26-6231-01



26-6231-02



26-6231-03



26-6231-04



26-6231-05



Doyen
26-6232-17
17 cm/6¾"



Doyen
26-6233-17
17 cm/6¾"



Segond
26-6234-27
27 cm/10½"

GYNECOLOGY

Secretion Spoon



26-6235-27
27 cm/10½"



Muenchen
27 cm/10½"



26-6236-04
4 mm



26-6236-05
5 mm



Randall
26-6237-24
24 cm/9½"

4 mmØ



Novak
23 cm/9"

- 26-6238-01
1 mm
- 26-6238-02
2 mm
- 26-6238-03
3 mm
- 26-6238-04
4 mm



Novak-Schoeckaert
26-6239-24
24 cm/9"

GYNECOLOGY



Kevorkian
26-6240-30
30 cm/12"

malleable
26-6241-30
30 cm/12"



Kevorkian
26-6242-30
30 cm/12"

malleable
26-6243-30
30 cm/12"



Townsend
26-6244-30
31 cm/12¼"

malleable
26-6245-30
31 cm/12¼"



Duncan
26-6246-31
31 cm/12¼"



Duncan
26-6247-31
31 cm/12¼"

GYNECOLOGY



Goodell
 26-6248-34
 34 cm/13½"



Kogan-Laser
 28 cm/11"

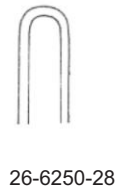

26-6251-28
 28 cm/11"

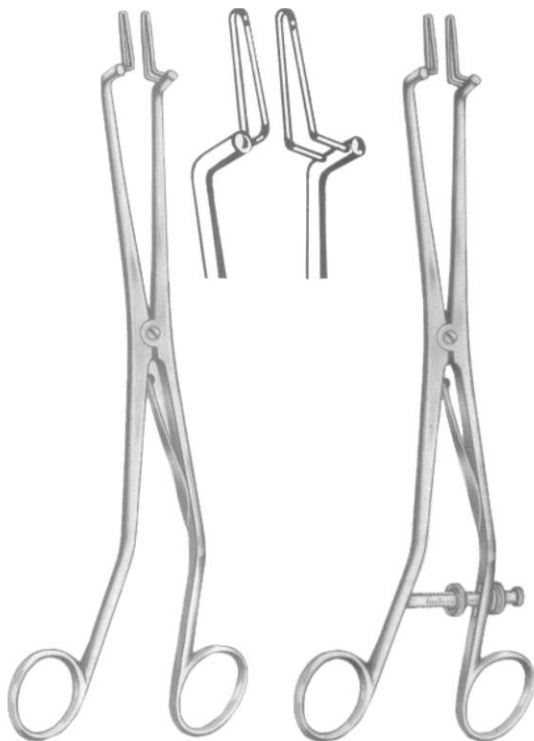

Kogan
 26-6252-24
 24 cm/9½"

Kogan
 26-6253-24
 24 cm/9½"

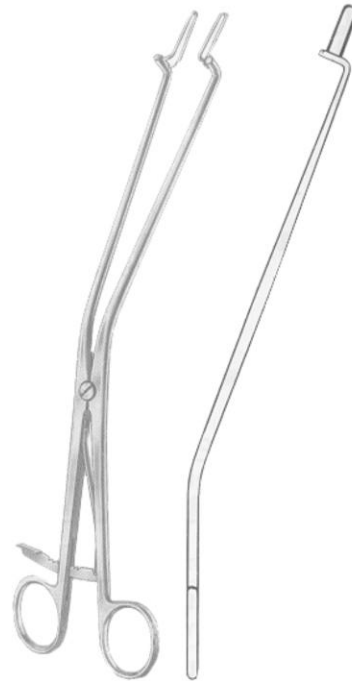

Kogan
 28 cm/11"



GYNECOLOGY

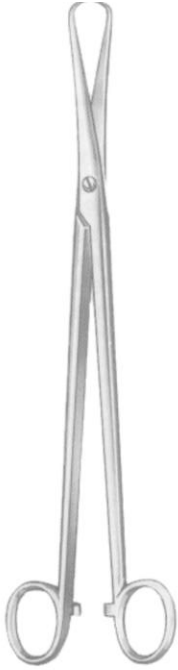

Martin
26-6256-27
27 cm/10½"

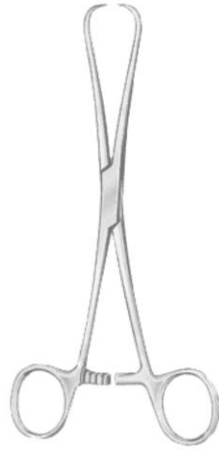

Staude-Moore
26-6257-17
17 cm/6¾"



Barrett
26-6258-18
18 cm/7"



Schroeder
26-6259-25
25 cm/10"



Braun
26-6260-25
25 cm/10"



Collin-Pozzi
26-6261-25
25 cm/10"



Pozzi
26-6262-25
25.5 cm/10¼"

Strong Pattern



Duplay
26-6263-28
28 cm/11"

GYNECOLOGY

Amniotome for the amnion Bladder



Skene
 26-6264-24
 24 cm/9½"



Beacham
 26-6265-26
 26 cm/10¼"



Czerny
 26-6266-20
 20.5 cm/8¼"



26-6267-26
 26 cm/10¼"



Schroeder
 26-6268-20 20 cm/8"
 26-6268-24 24 cm/9½"

Straight



Schroeder
 26-6269-20
 26-6269-24

Curved on Flat



Schroeder
 26-6270-20
 26-6270-24

Curved Sideway

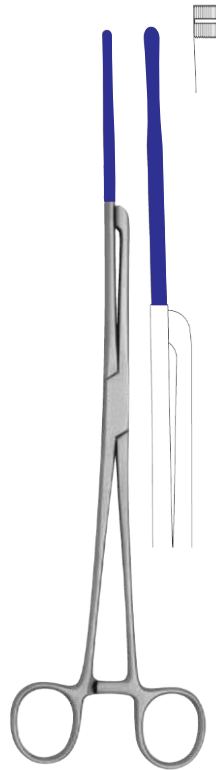

Atrauma
 26-6271-29
 Vulsellum Forceps
 29cm/11 ½"

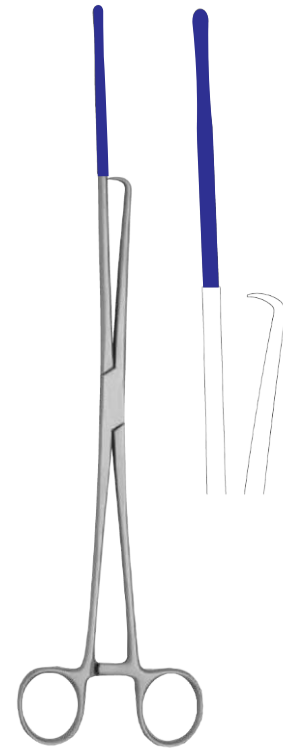

Luer
 26-6272-30
 Vulsellum Forceps
 30.5cm/12"

GYNECOLOGY



Atrauma
26-6273-29
29cm/11 1/2"



Bozeman
26-6274-27
27cm/10 1/2"

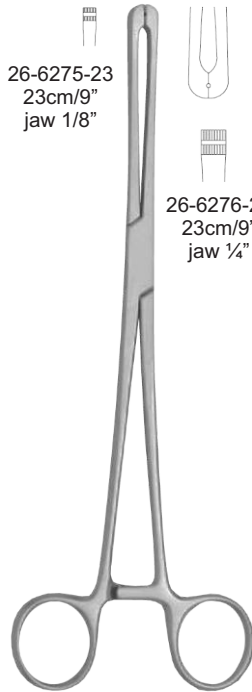

26-6275-23
23cm/9"
jaw 1/8"

26-6276-23
23cm/9"
jaw 1/4"



Rotunda
26-6277-27
27cm/10 1/2"

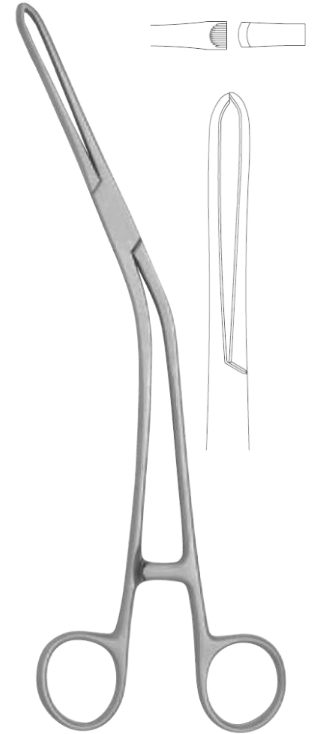

Bierer
26-6278-24
24cm/9 1/2"



Straight
26-6279-06
26-6279-08
26-6279-10



Museux
24 cm/9 1/2"
06 mm
08 mm
10 mm



Curved Sideway
26-6280-06
26-6280-08
26-6280-10



Straight
26-6281-06
26-6281-08
26-6281-10



Museux
24 cm/9 1/2"
06 mm
08 mm
10 mm



Curved Sideway
26-6282-06
26-6282-08
26-6282-10



Braun
26-6283-16
16 cm/6 1/4"

GYNECOLOGY

For the amnion Bladder



Pratt
 26-6284-28
 28 cm/11"



Teale
 26-6285-24
 24 cm/9½"



Iowa
 26-6286-26
 26 cm/10¼"



Jacobs
 Straight Curved Sideway
 26-6287-21 26-6288-21
 21 cm/8¼"



Bonney Polypus
 26-6289-26
 24 cm/9 ½"



Kelly
 26-6290-32
 32 cm/12½"



Heywood-Smith
 26-6291-20
 20 cm/8"

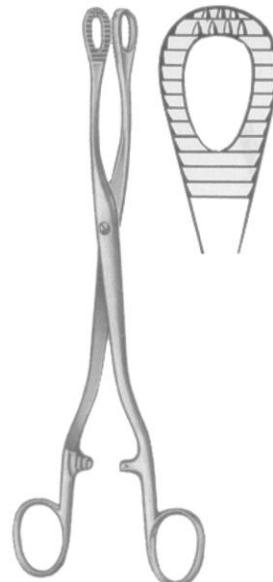

Heywood-Smith
 26-6292-25
 25 cm/10"



Noto
 26-6293-27
 27 cm/10½"

GYNECOLOGY



Dartigues
26-6294-27
27 cm/10 1/2"



Somer
26-6295-23
23 cm/9"



Collin
26-6296-25
25 cm/10"



Ovarian Forceps
Doyen
26-6297-18 18 cm/7"
26-6297-20 20 cm/8"



Bonney
26-6298-34
34.5 cm/13 1/2"



Bonney
26-6299-27
27 cm/10 1/2"



Bonney
26-6300-20
20 cm/8"
curved

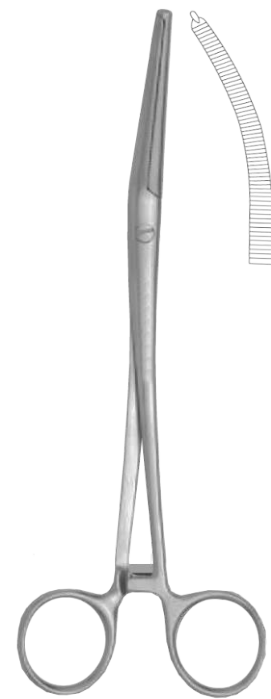

Bonney Berkley
26-6301-20
20 cm/8"
angled

GYNECOLOGY



Gellhorn
 26-6302-23
 23 cm/9"



Thoms-Gaylor
 26-6303-24
 24 cm/9½"



Schubert
 26-6304-21 21 cm/8 ¼"
 26-6304-29 29 cm/11¼"



Schubert
 26-6305-26
 26 cm/10¼"



Tischler
 26-6306-27
 27 cm/10½"

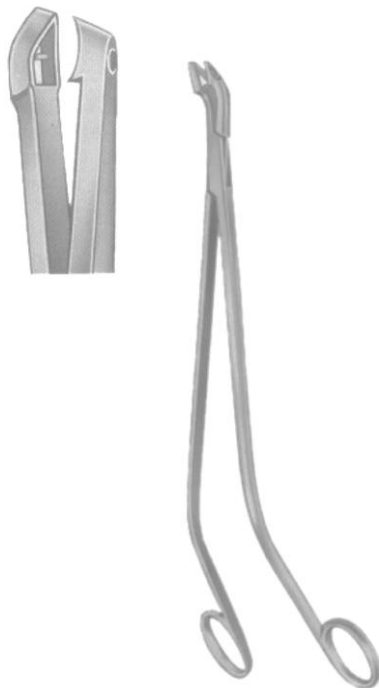

Van Doren
 26-6307-25
 25 cm/10"

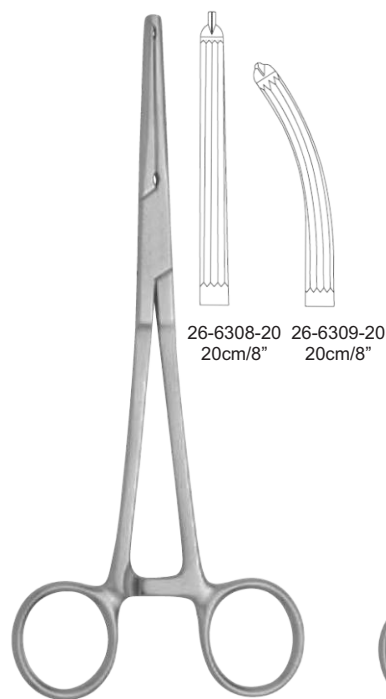

Gwilliam

26-6308-20 20cm/8"
 26-6309-20 20cm/8"



Hunter
 26-6310-23
 23 cm/9"

GYNECOLOGY

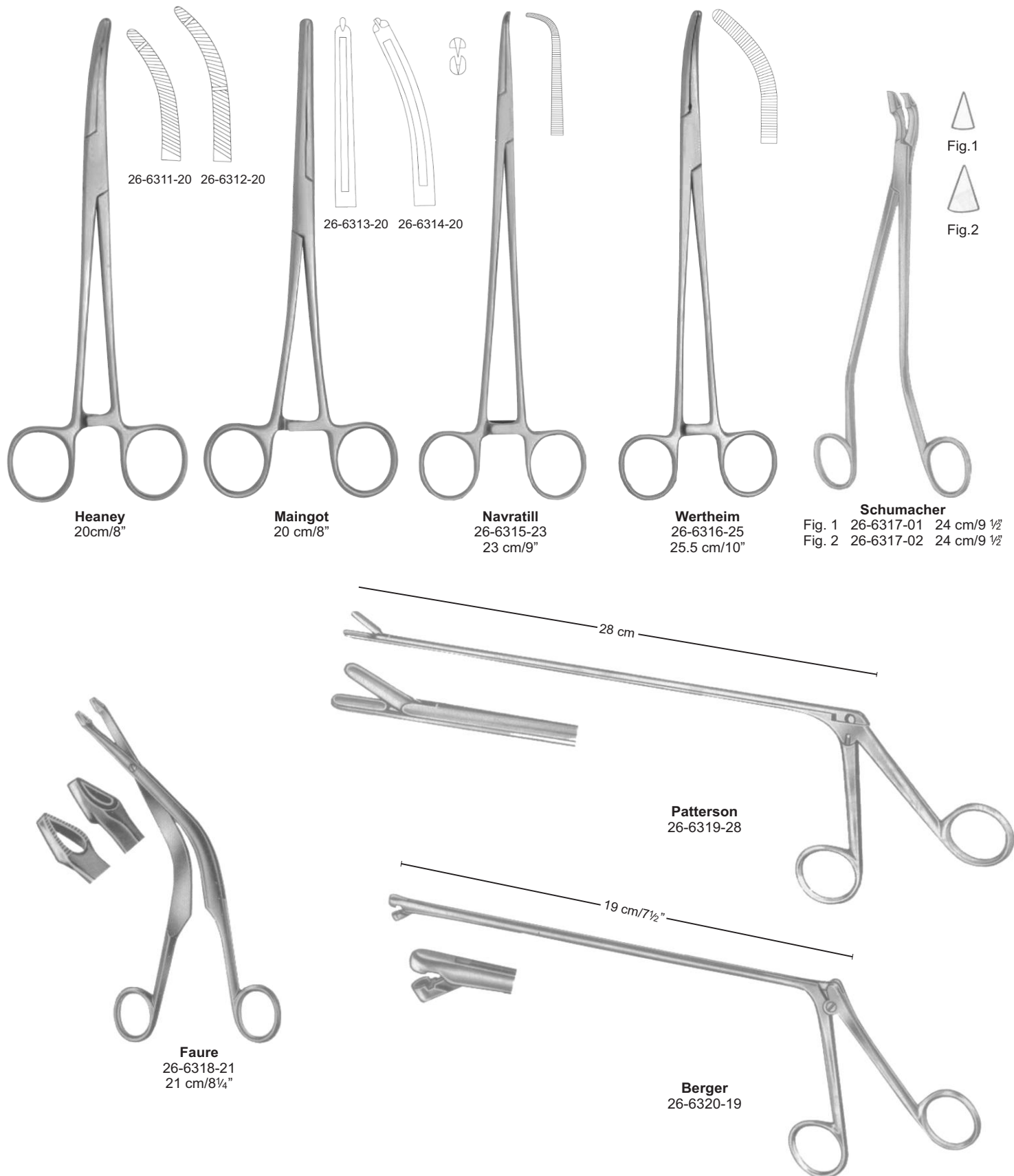

GYNECOLOGY

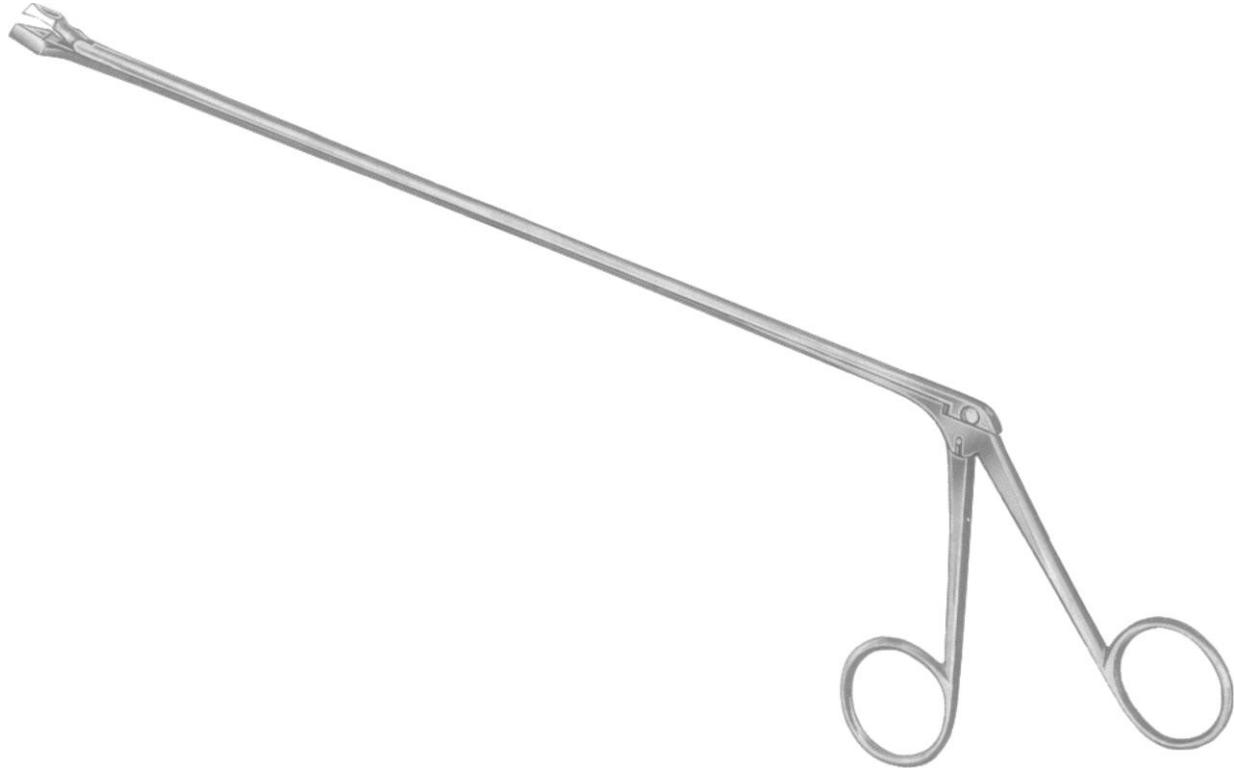

26-6321-20 L= 20 cm/8"
 26-6321-25 L= 25 cm/10"
 26-6321-30 L= 30 cm/12"
 26-6321-35 L= 35 cm/14"
 26-6321-40 L= 40 cm/16"

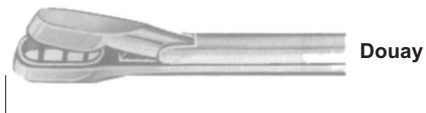

Douay

L = 24 cm/9½"



Schumacher

26-6323-04 26-6323-06
 4 mm 6 mm

L = 24 cm/9½"



Kevorkian

26-6325-24

L = 20 cm/8"



Eppendorf

26-6322-20

L = 23 cm/9"

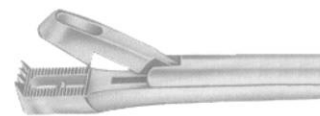

Wittner

26-6324-23

L = 23 cm/9"

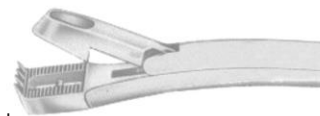

Wittner

26-6326-23

GYNECOLOGY

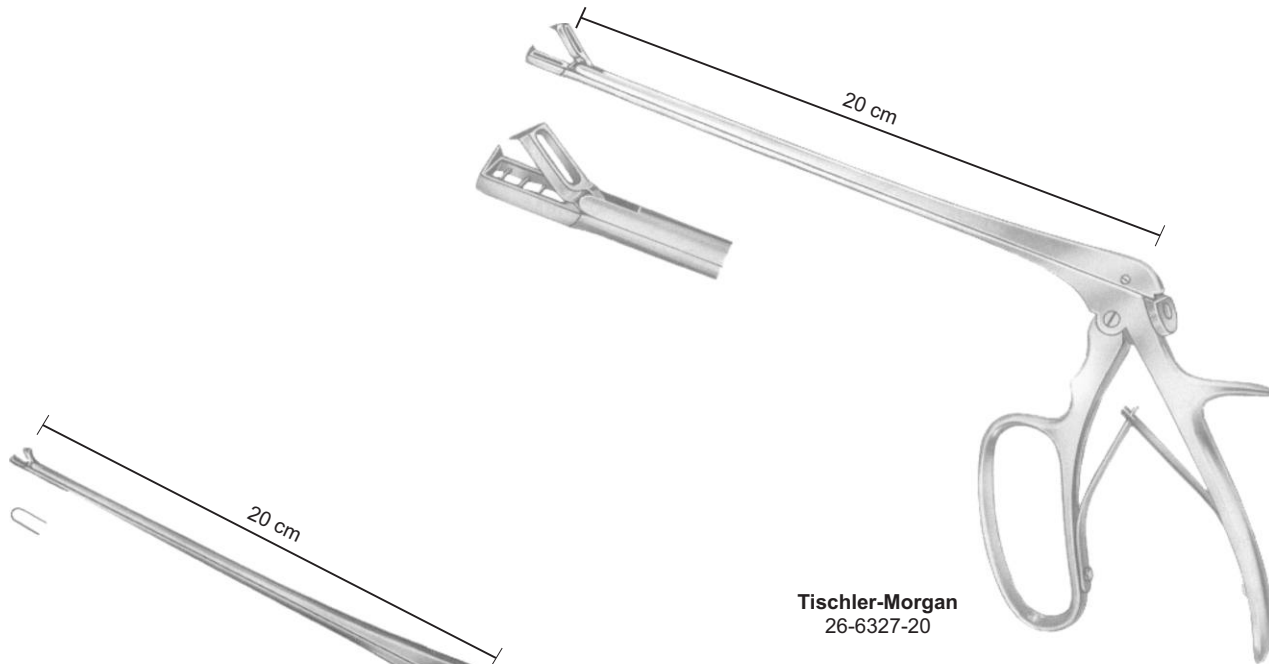

Tischler-Morgan
26-6327-20

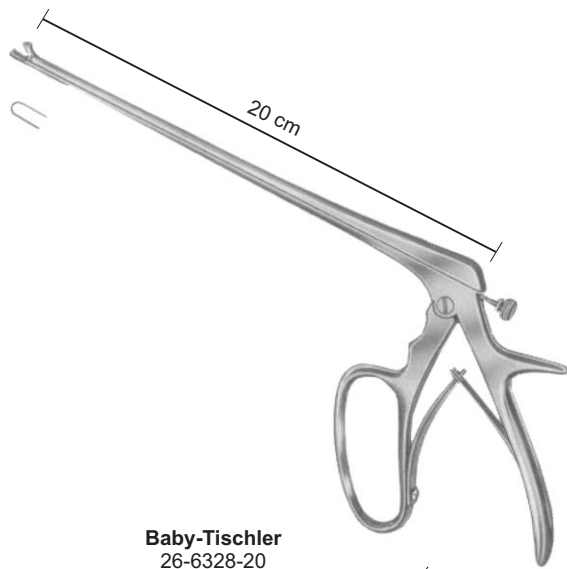

Baby-Tischler
26-6328-20

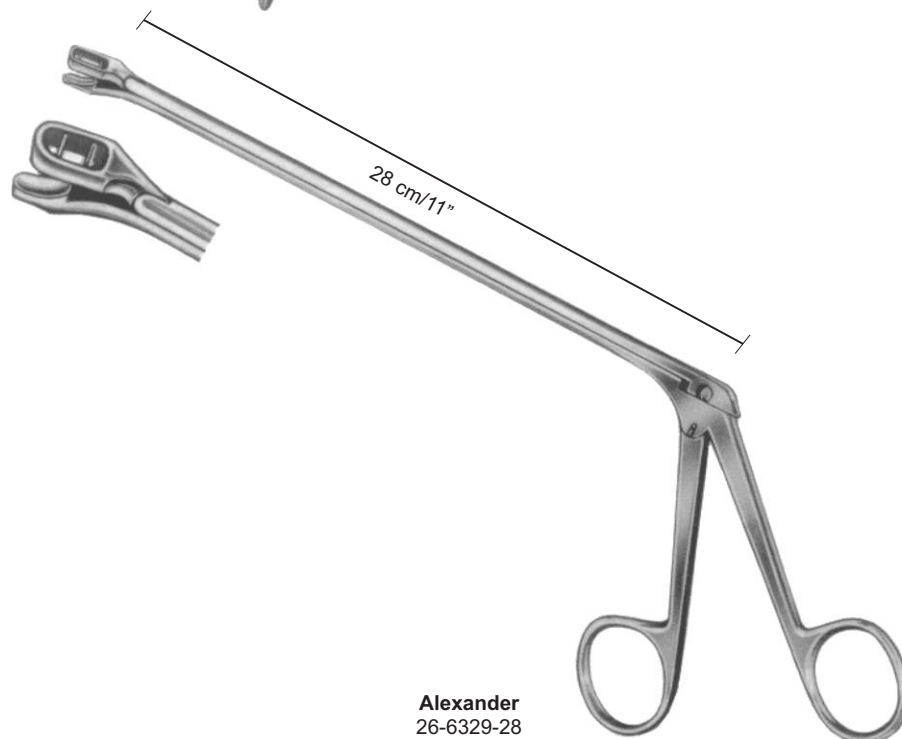

Alexander
26-6329-28

GYNECOLOGY

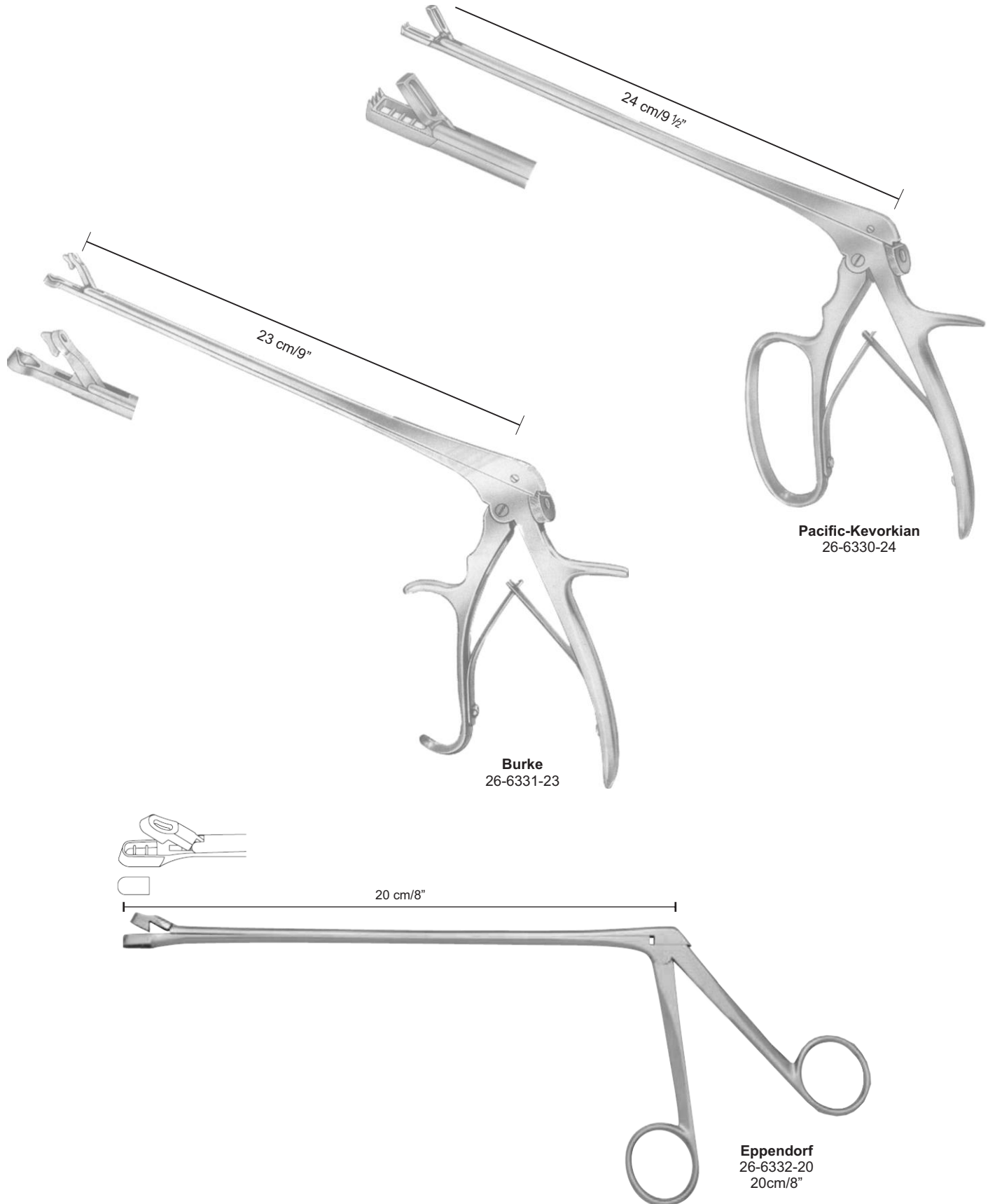

GYNECOLOGY











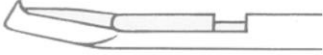

Handle

Townsend

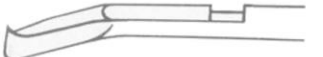

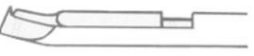
Tip with tube

		Complete instrument	Tip, only
	Tischler	26-6333-00	26-6334-01
	Kevorkian	26-6335-00	26-6336-01
	Mini-Townsend	26-6337-00	26-6338-01
	 Tischler-up	26-6339-00	26-6340-01
	 Tischler-down	26-6341-00	26-6342-01
	 Mini-Townsend-up	26-6343-00	26-6344-01
	 Mini-Townsend-down	26-6345-00	26-6346-01

GYNECOLOGY



Schroeder
30 cm/12"

Sharp Rigid



Fig. 1
26-6347-01
26-6348-01



Fig. 2
26-6349-02
26-6350-02



Fig. 3
26-6351-03
26-6352-03



Fig. 4
26-6353-04
26-6354-04



Fig. 5
26-6355-05
26-6356-05



Fig. 6
26-6357-06
26-6358-06

Schroeder
Simon

Schroeder
Simon



Simon
25 cm/10"



Gourdet
28 cm/11"



Fig. 1
26-6359-01
6 mm



Fig. 2
26-6359-02
8 mm



Fig. 3
26-6359-03
10 mm



Fig. 4
26-6359-04
12 mm



Fig. 5
26-6359-05
14 mm

GYNECOLOGY



Thomas



Fig. 1
26-6360-01



Fig. 2
26-6360-02



Fig. 3
26-6360-03



Fig. 4
26-6360-04



Fig. 5
26-6360-05



Fig. 6
26-6360-06



Greene

26-6361-10
10 mm

26-6361-12
12 mm

26-6361-14
14 mm



Collin
26-6362-30
30 cm/12"



Heaney
26-6363-24
24 cm/9½"





Heaney
26-6364-24
24 cm/9½"

GYNECOLOGY



Milan
 28.5 cm/11¼"

			
Malleable	26-6365-05 5 mm Ø	26-6367-07 7 mm Ø	26-6369-09 9 mm Ø
Rigid	26-6366-05 5 mm Ø	26-6368-07 7 mm Ø	26-6370-09 9 mm Ø



28 cm/11"

Hose Connecting Piece



26-6372-00

	Ø
26-6371-04	4.0 mm
26-6371-06	6.0 mm
26-6371-08	8.0 mm
26-6371-10	10.0 mm
26-6371-12	12.0 mm
26-6371-14	14.0 mm
26-6371-16	16.0 mm

GYNECOLOGY



Sims
25 cm/10"

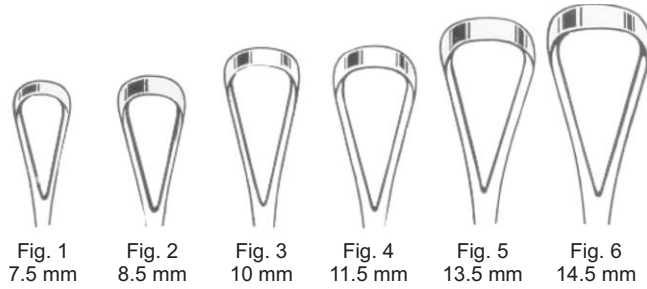

Fig. 1 7.5 mm Fig. 2 8.5 mm Fig. 3 10 mm Fig. 4 11.5 mm Fig. 5 13.5 mm Fig. 6 14.5 mm

Malleable		Rigid	
Sharp	Blunt	Sharp	Blunt

Fig. 1	26-6373-01	26-6374-01	26-6375-01	26-6376-01
Fig. 2	26-6373-02	26-6374-02	26-6375-02	26-6376-02
Fig. 3	26-6373-03	26-6374-03	26-6375-03	26-6376-03
Fig. 4	26-6373-04	26-6374-04	26-6375-04	26-6376-04
Fig. 5	26-6373-05	26-6374-05	26-6375-05	26-6376-05
Fig. 6	26-6373-06	26-6374-06	26-6375-06	26-6376-06



Sims
25 cm/10"

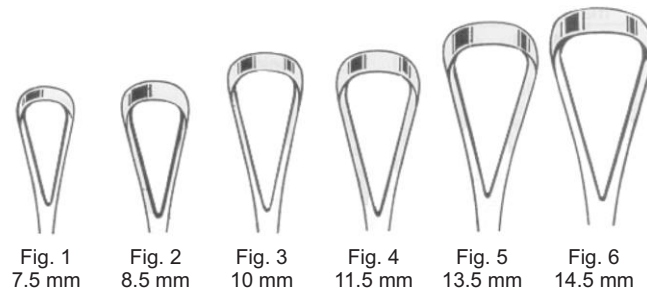

Fig. 1 7.5 mm Fig. 2 8.5 mm Fig. 3 10 mm Fig. 4 11.5 mm Fig. 5 13.5 mm Fig. 6 14.5 mm

Malleable		Rigid	
Sharp	Blunt	Sharp	Blunt

Fig. 1	26-6377-01	26-6378-01	26-6379-01	26-6380-01
Fig. 2	26-6377-02	26-6378-02	26-6379-02	26-6380-02
Fig. 3	26-6377-03	26-6378-03	26-6379-03	26-6380-03
Fig. 4	26-6377-04	26-6378-04	26-6379-04	26-6380-04
Fig. 5	26-6377-05	26-6378-05	26-6379-05	26-6380-05
Fig. 6	26-6377-06	26-6378-06	26-6379-06	26-6380-06

GYNECOLOGY

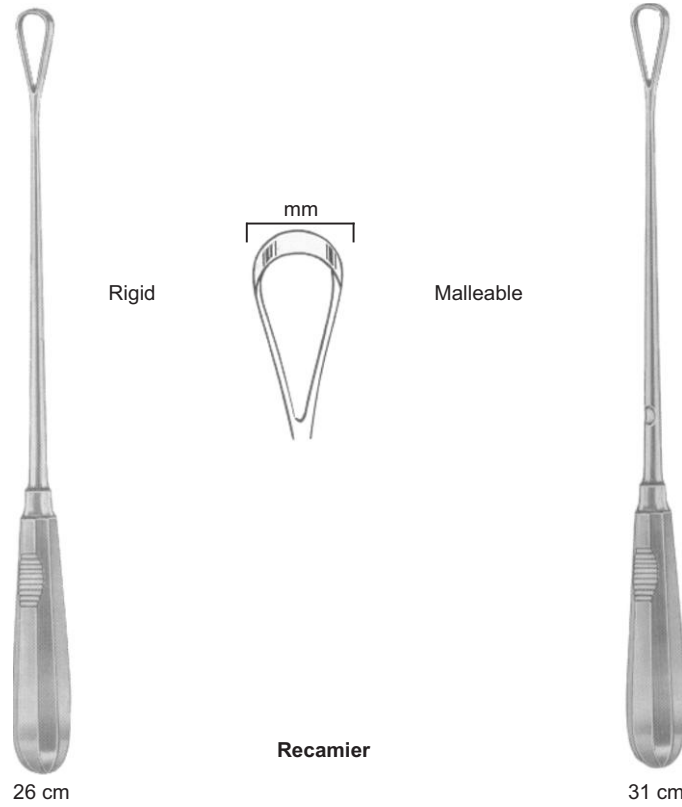

Fig.	mm	Malleable		Rigid		Malleable		Rigid	
		Sharp	Blunt	Sharp	Blunt	Sharp	Blunt	Sharp	Blunt
00	5	26-6381-05	26-6382-05	26-6383-05	26-6384-05	26-6385-05	26-6386-05	26-6387-05	26-6388-05
0	6	26-6381-06	26-6382-06	26-6383-06	26-6384-06	26-6385-06	26-6386-06	26-6387-06	26-6388-06
1	7	26-6381-07	26-6382-07	26-6383-07	26-6384-07	26-6385-07	26-6386-07	26-6387-07	26-6388-07
2	8	26-6381-08	26-6382-08	26-6383-08	26-6384-08	26-6385-08	26-6386-08	26-6387-08	26-6388-08
3	9	26-6381-09	26-6382-09	26-6383-09	26-6384-09	26-6385-09	26-6386-09	26-6387-09	26-6388-09
4	10	26-6381-11	26-6382-11	26-6383-11	26-6384-11	26-6385-11	26-6386-11	26-6387-11	26-6388-11
5	12	26-6381-12	26-6382-12	26-6383-12	26-6384-12	26-6385-12	26-6386-12	26-6387-12	26-6388-12
6	14	26-6381-14	26-6382-14	26-6383-14	26-6384-14	26-6385-14	26-6386-14	26-6387-14	26-6388-14
7	15	26-6381-15	26-6382-15	26-6383-15	26-6384-15	26-6385-15	26-6386-15	26-6387-15	26-6388-15
8	16	26-6381-16	26-6382-16	26-6383-16	26-6384-16	26-6385-16	26-6386-16	26-6387-16	26-6388-16
9	19	26-6381-19	26-6382-19	26-6383-19	26-6384-19	26-6385-19	26-6386-19	26-6387-19	26-6388-19
10	20	26-6381-20	26-6382-20	26-6383-20	26-6384-20	26-6385-20	26-6386-20	26-6387-20	26-6388-20
11	21	26-6381-21	26-6382-21	26-6383-21	26-6384-21	26-6385-21	26-6386-21	26-6387-21	26-6388-21
12	23	26-6381-23	26-6382-23	26-6383-23	26-6384-23	26-6385-23	26-6386-23	26-6387-23	26-6388-23
13	25					26-6385-25	26-6386-25	26-6387-25	26-6388-25
14	30					26-6385-30	26-6386-30	26-6387-30	26-6388-30
15	35					26-6385-35	26-6386-35	26-6387-35	26-6388-35
16	40					26-6385-40	26-6386-40	26-6387-40	26-6388-40

GYNECOLOGY



Bumm
max. 29 cm/11½"

Fig.	mm	Mealleable	
		Sharp	Blunt
0	16.0	26-6389-16	26-6390-16
1	18.0	26-6389-18	26-6390-18
2	19.5	26-6389-19	26-6390-19
3	21.5	26-6389-21	26-6390-21
4	23.5	26-6389-23	26-6390-23
5	26.0	26-6389-26	26-6390-26
6	28.5	26-6389-28	26-6390-28



Blunt

Sharp

Blake (Zweifel)
26-6391-27 27 cm/10½"
26-6391-31 31 cm/12¼"

GYNECOLOGY



Zeppelin Scissor with TC

slightly curved
 26-6392-23
 23cm/9"
 26-6392-26
 26.5cm/10 1/2"
 26-6392-30
 30cm/12"

curved
 26-6393-23
 23cm/9"
 26-6393-26
 26.5cm/10 1/2"
 26-6393-30
 30cm/12"

Fully curved
 26-6394-23
 23cm/9"
 26-6394-26
 26.5cm/10 1/2"
 26-6394-30
 30cm/12"

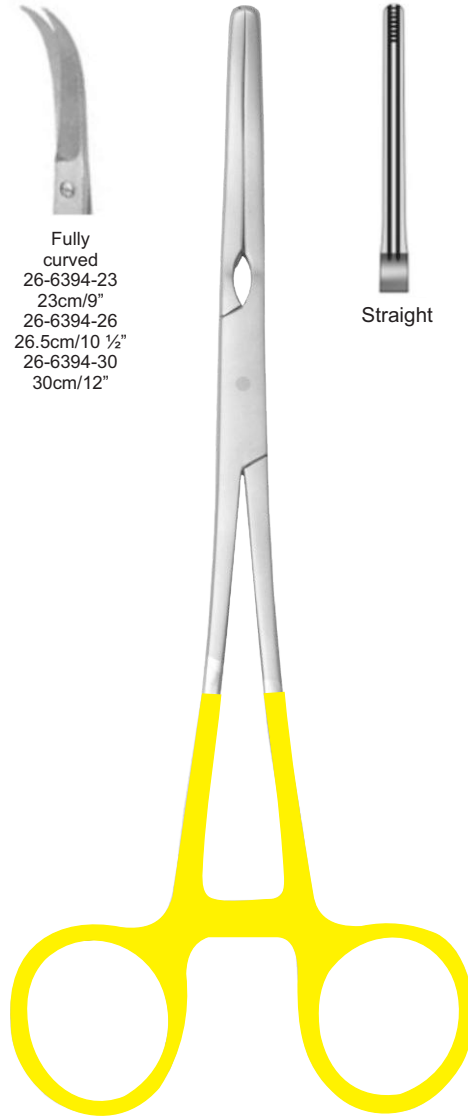

Zeppelin Clamps

offset handle with gold rings (without TC)

Straight	26-6395-21	26-6399-24	26-6403-30	26-6407-35
Slightly Curved	26-6396-21	26-6400-24	26-6404-30	26-6408-35
Strongly Curved	26-6397-21	26-6401-24	26-6405-30	26-6409-35
Angled	26-6398-21	26-6402-24	26-6406-30	26-6410-35
	21.5cm/8 1/2"	24cm/9 1/2"	30cm/12"	35cm/14"

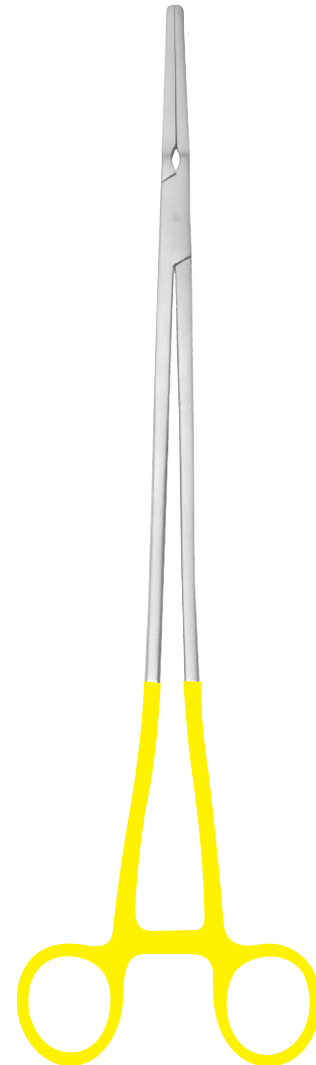

Zeppelin Clamps

Straight Handle with gold rings (without TC)

Straight	26-6411-21	26-6415-24	26-6419-30	26-6423-35
Slightly Curved	26-6412-21	26-6416-24	26-6420-30	26-6424-35
Strongly Curved	26-6413-21	26-6417-24	26-6421-30	26-6425-35
Angled	26-6414-21	26-6418-24	26-6422-30	26-6426-35
	21.5cm/8 1/2"	24cm/9 1/2"	30cm/12"	35cm/14"

- EN** Obstetrics
- DE** Geburtshilfe
- ES** Obstetricia

Page 559 to 565

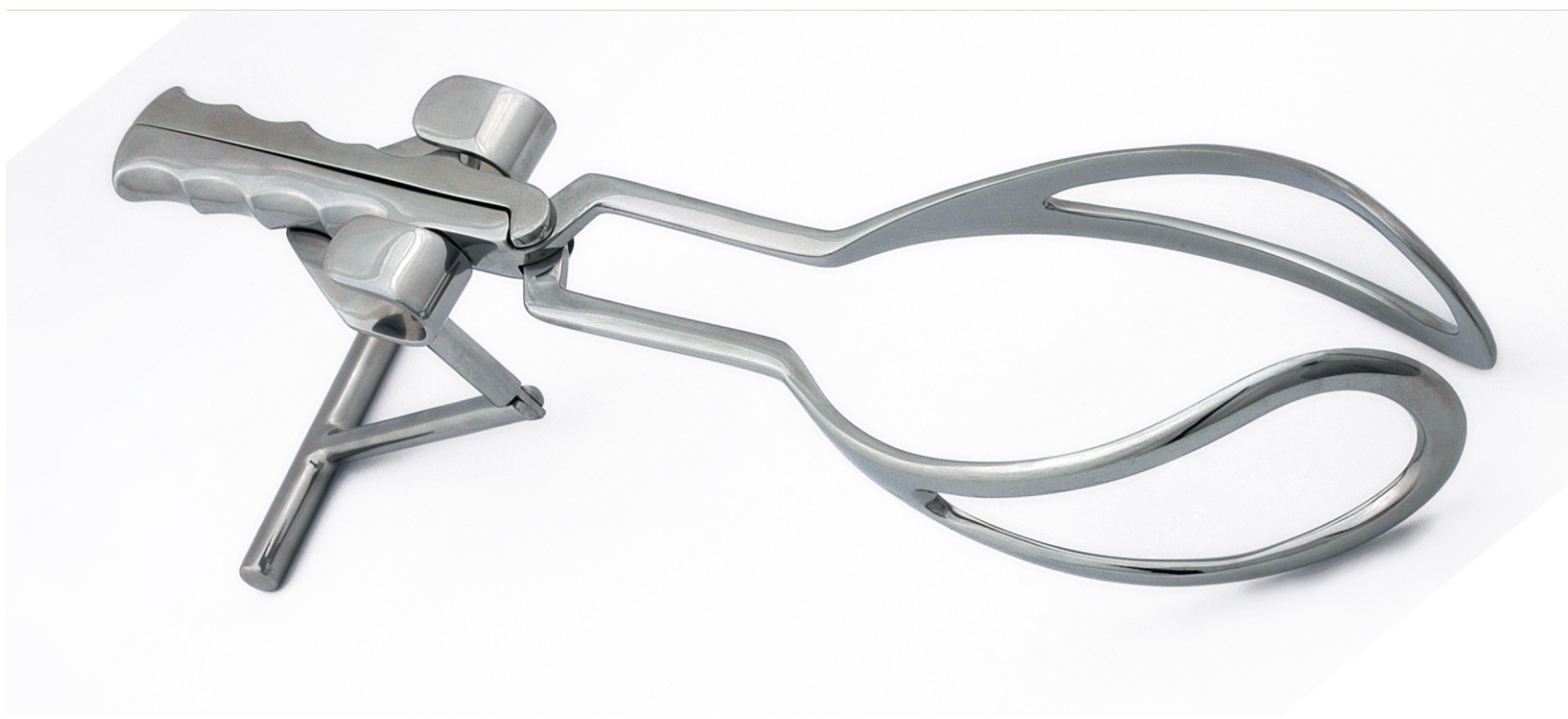

OBSTETRICS

For Internal Measurements



27-6501-45
Laparotomy Ring
1 3/4" Inside Diameter



De Lee
27-6502-20
20 cm/8"
cm/Inch Scale



Martin
27-6503-34 34 cm/13 1/2" 27-6504-34
cm Scale cm/Inch Scale



Collin
27-6505-35
35 cm/13 3/4"
cm Scale



Breisky
27-6506-33
33 cm/13"
cm Inch Scale



Collyer
27-6507-30
30 cm/12"
cm Inch Scale



Iowa
27-6508-14
14 cm/5 1/2"
Trumpet Needle Guide

OBSTETRICS



Winter
28 cm/11"

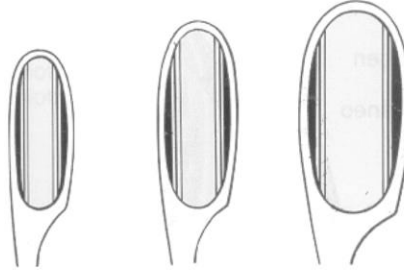

Straight	27-6509-01	27-6509-02	27-6509-03
Curved	27-6510-01	27-6510-02	27-6510-03



Wallich
27-6511-42
42 cm/16¾"

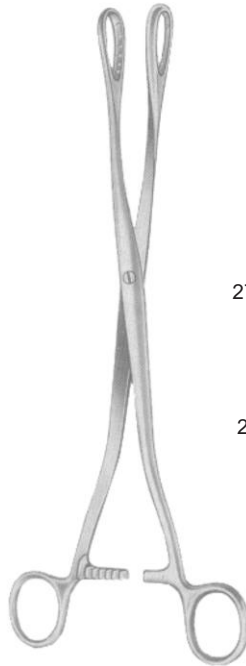

Straight
27-6512-27

Curved
27-6513-27

Sanger
21 cm/10½"

Uterine Haemostasis Forceps



Green-Armytage
27-6514-21
21 cm/8¼"

OBSTETRICS

Scalp Flap Forceps



Gauss
27-6515-26
26 cm/10¼"



Willet-Martel
27-6516-19
19 cm/7½"

Head Lever



Murless
27-6517-26
26 cm/10¼"

Elevating Spoon



Sellheim
27-6518-28
28 cm/11"



Smellie
27-6519-25
25 cm/10"

Perforators



Nagele
27-6520-25
25 cm/10"

OBSTETRICS

Cranioclast



Braun
 27-6521-42
 42 cm/16½"

Basiotribe

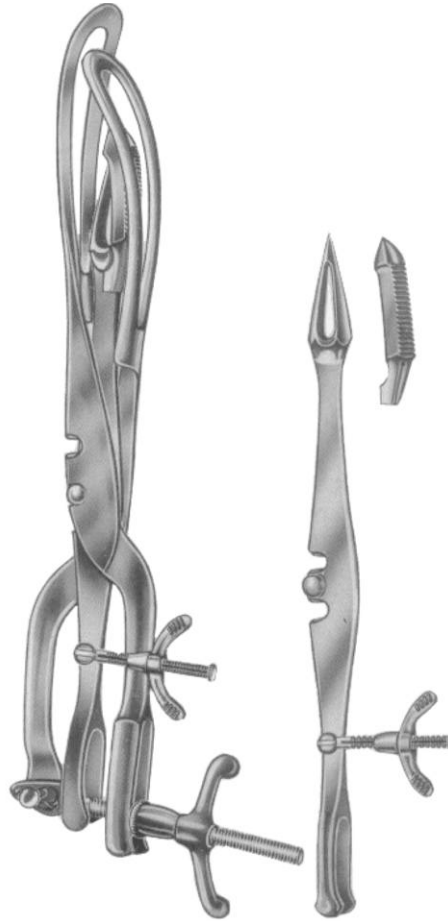

Tarnier
 27-6522-46
 46 cm/18"

Decapitating Hook



Braun
 27-6523-30
 30 cm/12"

Umbilical Cord Clamps



Collin
 27-6524-09
 9 cm/3½"

OBSTETRICS



Nagele
27-6525-36 36 cm/14"
27-6525-40 40 cm/16"



Wrigley
27-6526-28
28 cm/11"



Simpson
27-6527-23
23 cm/9"



Simpson
27-6528-28 28cm/11"
27-6528-38 38cm/15"



Simpson-Braun
27-6529-36
36 cm/14"



Simpson-Luikart
27-6530-36
36 cm/14"

OBSTETRICS



De Lee
 27-6531-30 30 cm/12"
 27-6532-36 36 cm/14"

Traction Handles to be used with all obstetrical Forceps with Standard type Handles

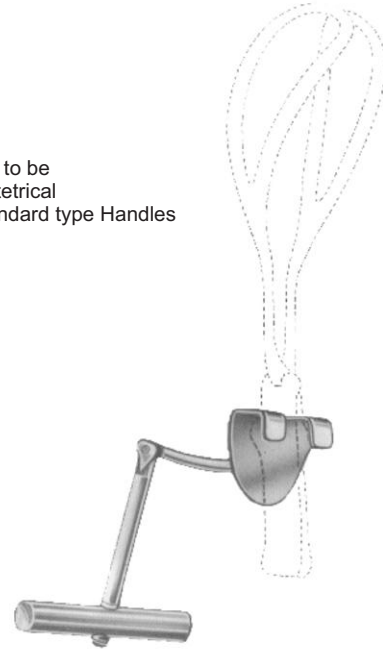

Bill
 27-6533-20



Kielland
 27-6534-41
 41 cm/16"



Kielland-Luikart
 27-6535-40
 40 cm/15¾"



Mclean
 27-6536-36
 36 cm/14"

OBSTETRICS



Elliot
27-6537-32 32 cm/12½"
27-6538-38 38 cm/15"



Piper
27-6539-44
44 cm/17¼"

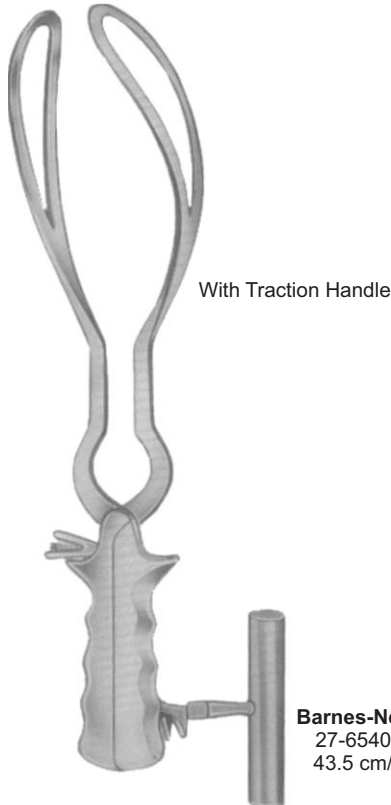

With Traction Handle

Barnes-Neville
27-6540-43
43.5 cm/17"

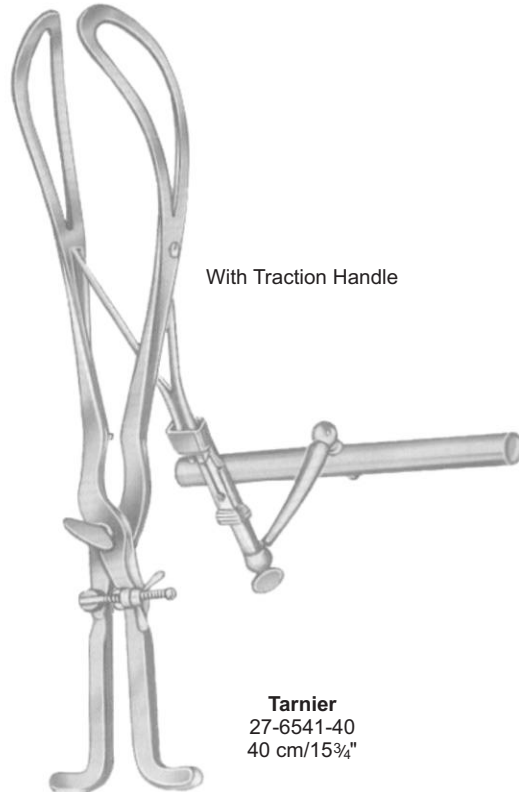

With Traction Handle

Tarnier
27-6541-40
40 cm/15¾"

- EN** Sterilization
- DE** Sterilisation
- ES** Esterilización

Page 566 to 567



STERILIZATION

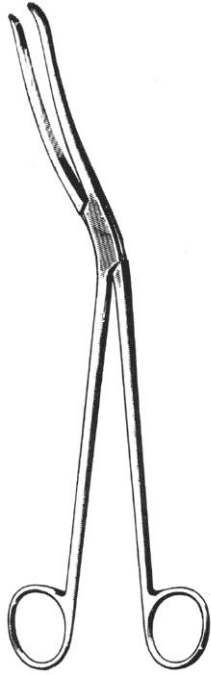

CHEATLE
28-6601-27 27.0cm

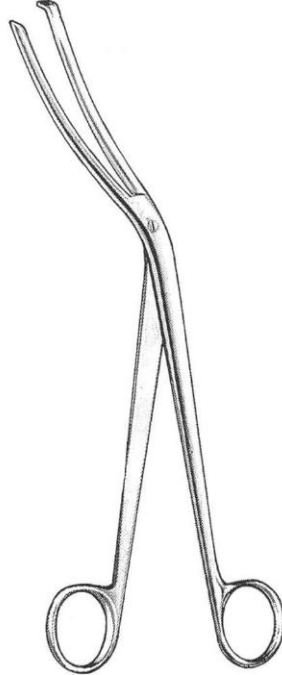

CHEATLE
28-6602-27 26.5cm

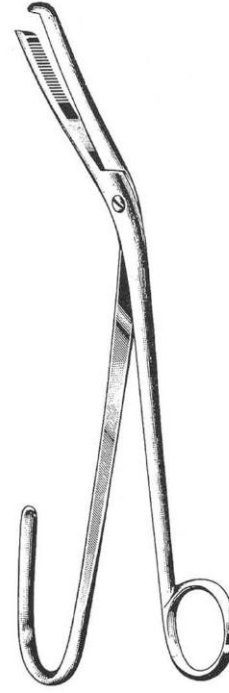

CHEATLE
28-6603-28 28.0cm



28-6604-20 20.0cm
28-6604-30 30.0cm

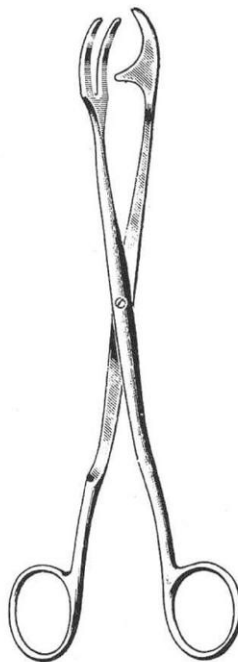

ROGGE
28-6605-23 23.0cm



DAVIS
28-6606-16 16.0cm
28-6606-20 20.0cm
28-6606-24 24.0cm

STERILIZATION

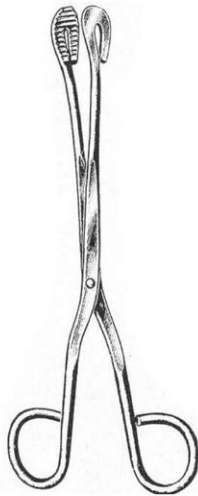

UNIVERSAL
 28-6607-20 20.0cm
 28-6607-28 28.0cm

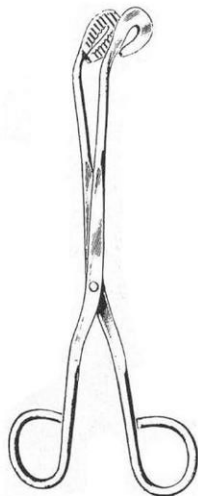

UNIVERSAL
 28-6608-20 20.0cm
 28-6608-28 28.0cm

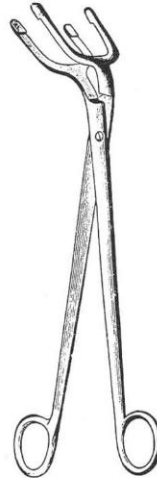

PYE-SMITH (HARRISON)
 28-6609-25 25.0cm
 28-6609-30 30.0cm

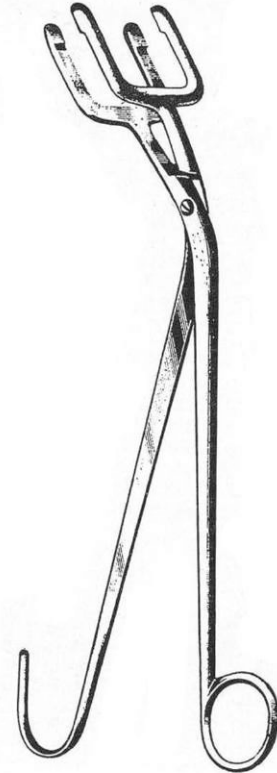

HARRISON
 28-6610-25 25.0cm
 28-6610-30 30.0cm
 28-6610-35 35.0cm
 28-6610-45 45.0cm

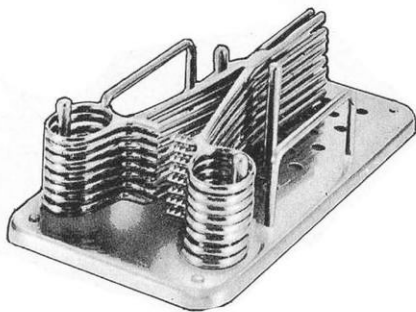

28-6611-00



BUNT
 28-6612-12 12.0cm

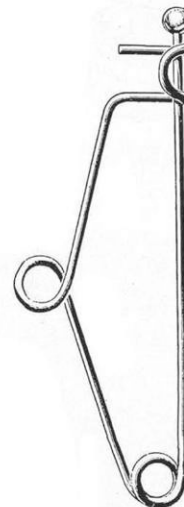

MAYO
 28-6613-10 10.0cm
 28-6613-12 12.0cm
 28-6613-14 14.0cm
 28-6613-15 15.0cm

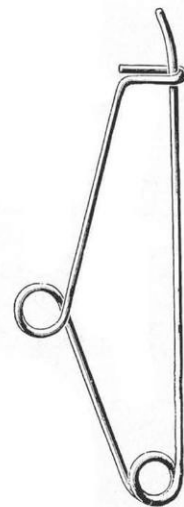

MAYO
 28-6614-14 14.0cm

EN Asepsis

DE Asepsis

ES Asepsia

Page 568 to 559



ASEPSIS

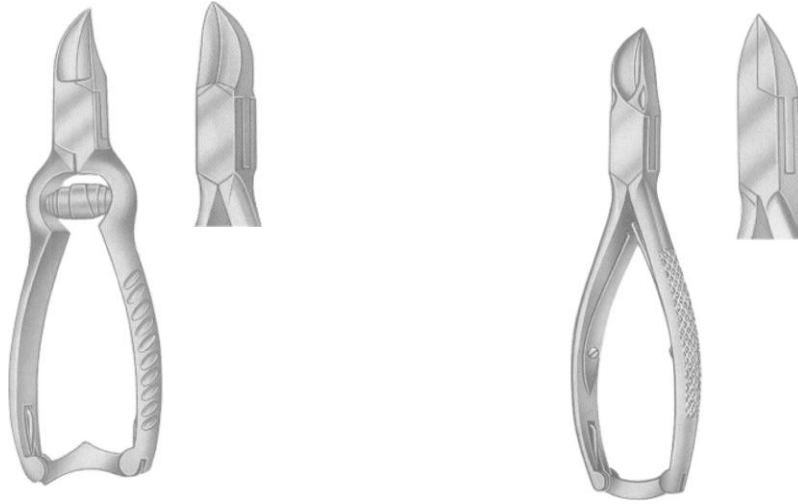

cm	in	
11	4½"	29-6701-11
13	5	29-6701-13
14	5½"	29-6702-14
16	6¼"	29-6702-16

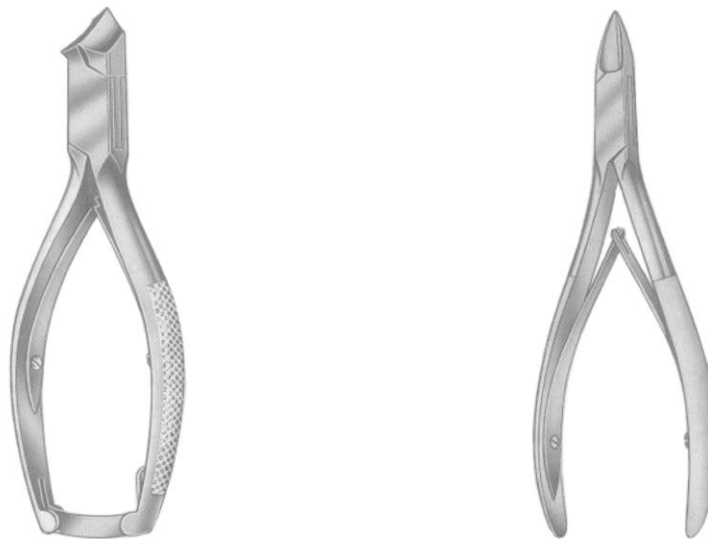

cm	in	
11	4½"	29-6704-11
13	5	29-6704-13
14	5½"	29-6703-14
15	6"	29-6703-15

ASEPSIS

Stainless

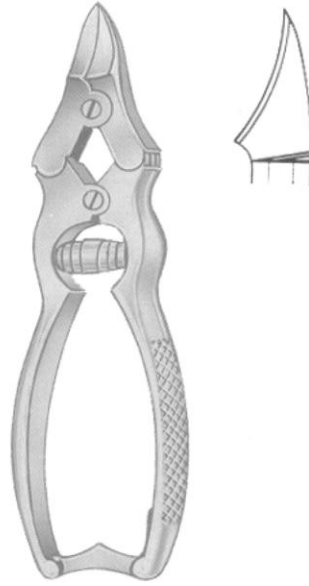
 29-6705-15
 15 cm/6"

 29-6706-10
 29-6706-10
 10 cm/4"

 Straight
 Curved

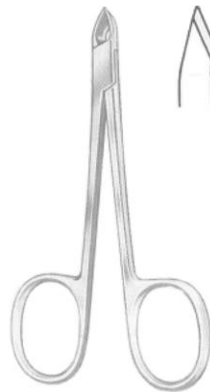
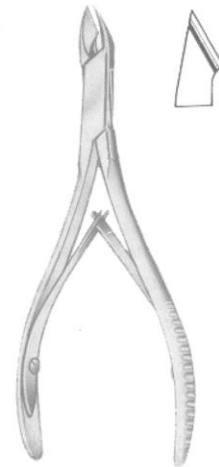
 29-6707-10
 29-6707-10
 10 cm/4"

 29-6708-10
 10 cm/4"

 29-6709-11
 11 cm/4½"
 29-6709-13
 13 cm/5"

EN Hollowware

DE Hollowware

ES Hollowware

Page 570 to 575



HOLLOWWARE



Needle Case Round with Cover
 30-6801-01 65x15mm



Needle Case Round
 30-6802-01 80x20mm



Needle Case Rectangle
 30-6803-01 70x70x10mm

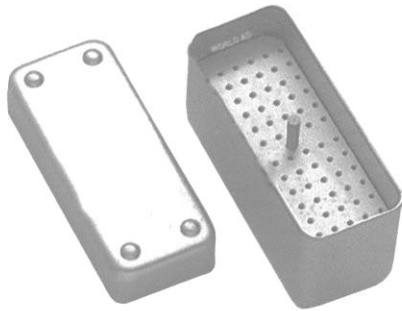

Endodontic Box
 30-6804-01
 100x40x50mm

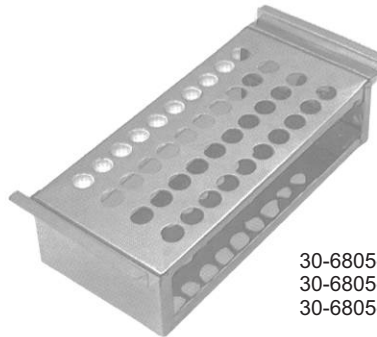

Tube Rack

30-6805-01 6.35x15.25x5cm for 12 tubes
 30-6805-02 6.35x17.75x7.5cm for 27 tubes
 30-6805-03 7.50x17.75x6.35cm for 36 tubes



Sprit Lamp
 30-6806-01
 Standard Size



Sprit Lamp
 30-6807-01
 Standard Size



Sputum Cup

30-6808-01 75x80mm
 30-6808-02 100x50mm
 30-6808-03 100x80mm



Dressing Jar

30-6809-01	80x60mm	30-6810-01
30-6809-02	80x80mm	30-6810-02
30-6809-03	100x100mm	30-6810-03
30-6809-04	120x120mm	30-6810-04
30-6809-05	150x150mm	30-6810-05
30-6809-06	180x180mm	30-6810-06
30-6809-07	200x200mm	30-6810-07



Dressing Jar



Fennle

30-6812-01 100mm Ø
 30-6812-02 120mm Ø
 30-6812-03 150mm Ø
 30-6812-04 200mm Ø



Cotton Holder
 30-6811-01



Cotton Holder
 30-6811A-01



HOLLOWWARE



Forceps Jar

30-6813-01	30x90mm
30-6813-02	50x125mm
30-6813-03	50x170mm
30-6813-04	50x200mm
30-6813-05	40x230mm
30-6813-06	70x110mm
30-6813-07	80x150mm
30-6813-08	100x200mm
30-6813-09	150x30mm



Medicine Cup

30-6816-01	50ml
30-6816-02	60ml
30-6816-03	70ml



Kick Bucket with Trolley

30-6819-01	390x280x180mm
------------	---------------

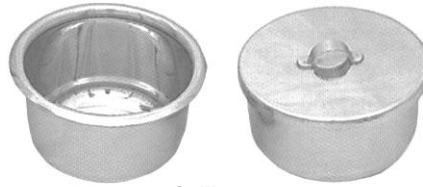

Gallipot

30-6814-01	01 oz	30-6814-09	09 oz
30-6814-02	02 oz	30-6814-10	10 oz
30-6814-03	03 oz	30-6814-11	11 oz
30-6814-04	04 oz	30-6814-12	12 oz
30-6814-05	05 oz	30-6814-13	13 oz
30-6814-06	06 oz	30-6814-14	14 oz
30-6814-07	07 oz	30-6814-15	15 oz
30-6814-08	08 oz	30-6814-16	16 oz



Sponge Bowl

30-6815-01	12 cm
30-6815-02	15 cm
30-6815-03	20 cm



Lotion Bowl without spout

30-6817-01	40x19mm	30-6817-08	150x65mm
30-6817-02	50x25mm	30-6817-09	180x85mm
30-6817-03	60x30mm	30-6817-10	200x100mm
30-6817-04	80x40mm	30-6817-11	250x120mm
30-6817-05	100x50mm	30-6817-12	300mm
30-6817-06	120x60mm	30-6817-13	350mm
30-6817-07	140x60mm	30-6817-14	400mm



Wash Basin

30-6818-01	300x80mm
30-6818-02	320x85mm
30-6818-03	330x90mm
30-6818-04	350x110mm
30-6818-05	400x115mm

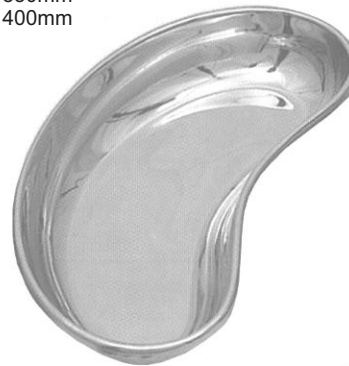

Kidney Tray

30-6821-01	12cm
30-6821-02	15cm
30-6821-03	18cm
30-6821-04	20cm
30-6821-05	25cm
30-6821-06	28cm
30-6821-07	30cm



Kidney Tray Shallow

30-6820-01	17cm
30-6820-02	22cm
30-6820-03	24cm



Kidney Tray (with cover)

30-6822-01	15cm
30-6822-02	20cm
30-6822-03	25cm
30-6822-04	30cm

HOLLOWWARE

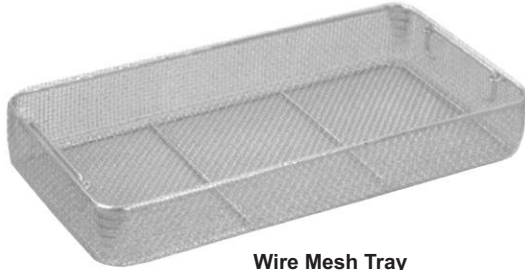

Wire Mesh Tray
 30-6823-01 240x250x5mm
 30-6823-02 480x250x5mm
 30-6823-03 550x250x5mm
 30-6823-04 240x250x7mm
 30-6823-05 480x250x7mm
 30-6823-06 240x250x10mm
 30-6823-07 480x250x10mm

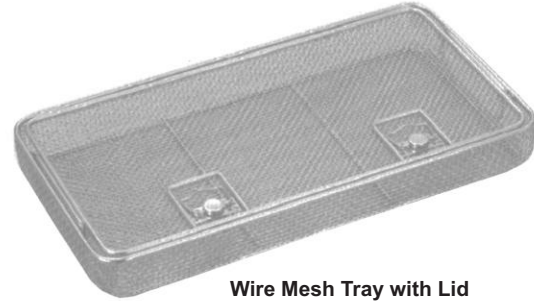

Wire Mesh Tray with Lid
 30-6824-01 240x250x5mm
 30-6824-02 480x250x5mm
 30-6824-03 550x250x5mm
 30-6824-04 240x250x7mm
 30-6824-05 480x250x7mm
 30-6824-06 240x250x10mm
 30-6824-07 480x250x10mm



Perforated Tray
 30-6825-01 200x100x40mm
 30-6825-02 250x120x50mm
 30-6825-03 300x150x50mm
 30-6825-04 350x170x50mm
 30-6825-05 400x200x50mm



Instruments Tray without Lid
 30-6826-01 100x150x25mm
 30-6826-02 150x200x40mm
 30-6826-03 200x250x45mm
 30-6826-04 250x300x50mm
 30-6826-05 300x350x50mm
 30-6826-06 150x300x50mm
 30-6826-07 200x300x50mm
 30-6826-08 230x150x50mm



Instruments Tray with Lid
 30-6827-01 100x150x25mm
 30-6827-02 150x200x40mm
 30-6827-03 200x250x45mm
 30-6827-04 250x300x50mm
 30-6827-05 300x350x50mm
 30-6827-06 150x300x50mm
 30-6827-07 200x300x50mm
 30-6827-08 230x150x50mm



Burr Tray
 30-6828-01
 190x100x20mm



Cathetes Tray with Lid
 30-6829-01 300x80x40mm
 30-6829-02 350x90x45mm
 30-6829-03 400x100x50mm

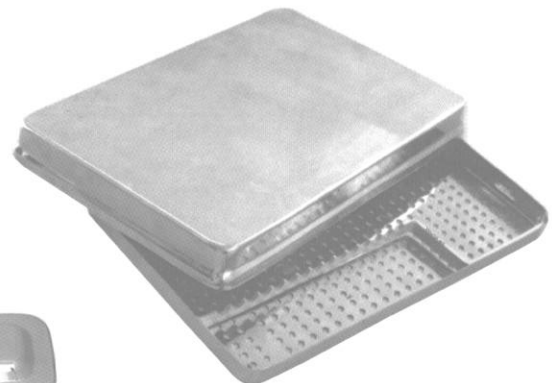

Scaler Tray with cover
 30-6830-01
 200x100x16mm

HOLLOWWARE



**Instruments Box
with Hooks**

30-6831-01 170x70x30mm
 30-6831-02 180x80x40mm
 30-6831-03 200x100x40mm
 30-6831-04 230x120x50mm
 30-6831-05 250x125x50mm
 30-6831-06 300x150x50mm
 30-6831-07 350x170x50mm
 30-6831-08 400x200x90mm
 30-6831-09 500x200x120mm



Instruments Box

30-6832-01 170x70x30mm
 30-6832-02 180x80x40mm
 30-6832-03 200x100x40mm
 30-6832-04 230x120x50mm
 30-6832-05 250x125x50mm
 30-6832-06 300x150x50mm
 30-6832-07 350x170x50mm
 30-6832-08 400x200x90mm
 30-6832-09 500x200x120mm



**Instruments Box
Perforated**

30-6833-01 200x100x40mm
 30-6833-02 250x150x40mm
 30-6833-03 300x150x40mm



Electric Sterilizer

30-6834-01 200x100x120mm
 30-6834-02 250x120x140mm
 30-6834-03 300x150x150mm
 30-6834-04 350x170x170mm
 30-6834-05 400x200x180mm
 30-6834-06 450x230x190mm

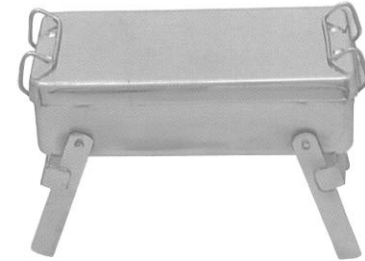

Non Electric Sterilizer

30-6835-01 200x100x65mm
 30-6835-02 250x125x65mm
 30-6835-03 300x150x100mm
 30-6835-04 350x170x65mm
 30-6835-05 400x200x100mm



Electric Sterilizer
 30-6836-01
 280x125x65mm

30-6837-01 125x80mm
 30-6837-02 125x120mm
 30-6837-03 150x100mm
 30-6837-04 150x150mm
 30-6837-05 180x180mm
 30-6837-06 190x140mm
 30-6837-07 190x190mm
 30-6837-08 200x200mm
 30-6837-09 240x120mm
 30-6837-10 240x240mm
 30-6837-11 290x140mm
 30-6837-12 290x240mm
 30-6837-13 290x290mm
 30-6837-14 340x160mm
 30-6837-15 340x340mm
 30-6837-16 390x150mm
 30-6837-17 390x200mm
 30-6837-18 390x290mm



Sterilizer Drum

HOLLOWWARE



Bedpan Hand Made
30-6838-01
Standard



Bedpan Hand Made
30-6839-01 Adult
30-6839-02 Child



Bedpan Hand Made
30-6840-01
Standard



**Bedpan Simple
pressed body with handle**
30-6842-01 Adult
30-6842-02 Child



Bedpan Sleeper Type
30-6843-01 Adult
30-6843-02 Child

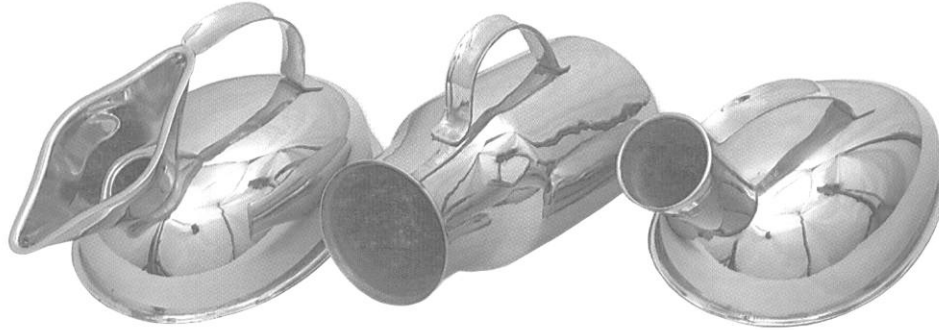

Bedpan Chamber Port
30-6844-01
Standard

HOLLOWWARE

Urinal Female
30-6845-01
Standard

Urinal Male Vertical
30-6846-01
Standard

Urinal Male
30-6847-01
Standard



**Bedpan perfection
type seamless**
30-6848-01
350x300mm



Bedpan perfection type
30-6849-01 370x290mm
30-6849-02 320x240mm



Dustbin
30-6851-01 210mm
30-6851-02 240mm
30-6851-03 270mm
30-6851-04 300mm



Pail/Bucket with Lid
30-6850-01 06 Ltr
30-6850-02 10 Ltr
30-6850-03 15 Ltr



Measuring Jug
30-6852-01 0.5 Ltr
30-6852-02 1.0 Ltr
30-6852-03 1.5 Ltr
30-6852-04 2.0 Ltr



Douch Can/Irrigator
30-6853-01 1.0 Ltr
30-6853-02 1.5 Ltr
30-6853-03 2.0 Ltr

Aqqfa Impex
232A, Small Industrial Estate
Sialkot 51340, Pakistan.

Cell: 0092 334 8648888
Tel: 0092 52 4593943

Email: aqqfaimpex@gmail.com
Email: info@aqqfa.com
Website: www.aqqfa.com